

Avolites LTD Engineering Change Notice

ECN title	Tiger Touch LCD Inverter enable delay		
ECN Number	ECN-193		
Related Product(s)	Tiger Touch systems of serial numbers 899-968; any Tiger Touch system with a three-wire inverter.		
Date / Author	30/05/2012	CH	
Reasons for ECN	Inverter may fail to power up when unit is switched on		
Parts required	1x 5V1/400mW Zener, 1x 10K Res, 1x 1N4148 Diode, 1x 22uF/35V capacitor		
Tools required	No.2 Pozi Screwdriver, Soldering Iron, De-soldering pump, optional T20 Torx-head screw driver		
Estimated time	30 minutes		

Safety Notice:

Disconnect the product from mains and any other electrical connection before opening the unit, use appropriate ESD measures when working inside the product.

Remove and retain the three screws from the underside of the front of the unit.

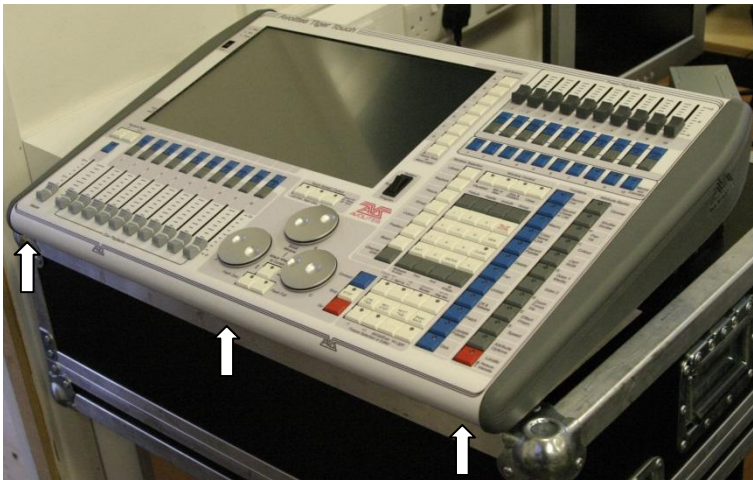

Lift the lid of the Tiger Touch, and engage the front panel prop.

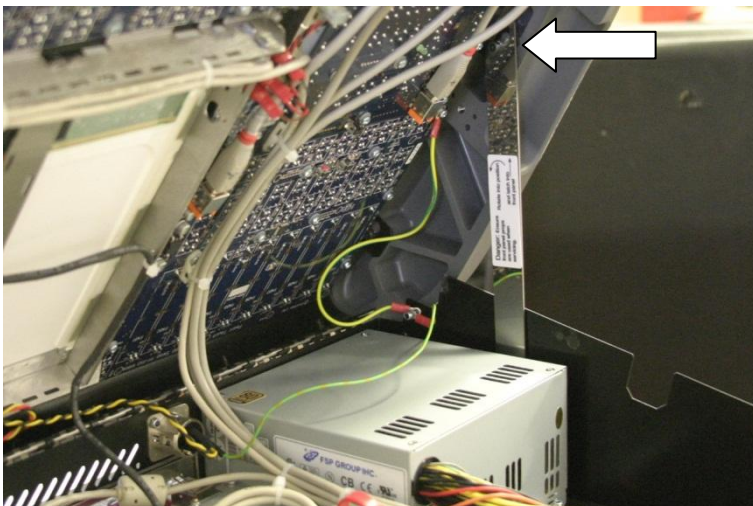

Locate the Power Switch Board (Arrow). Disconnect the four looms from the power switch board, it may be necessary to cut one or more cable ties, and then remove the three screws No. 2 pozi screwdriver.

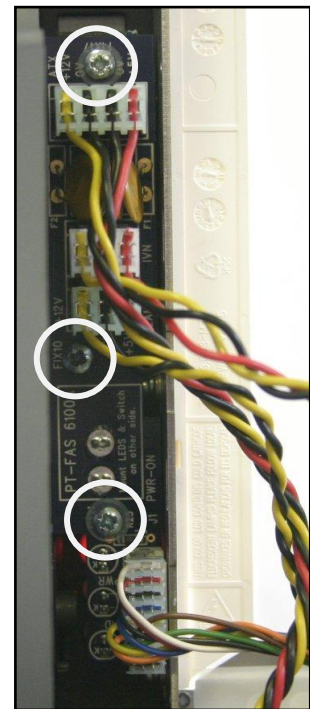
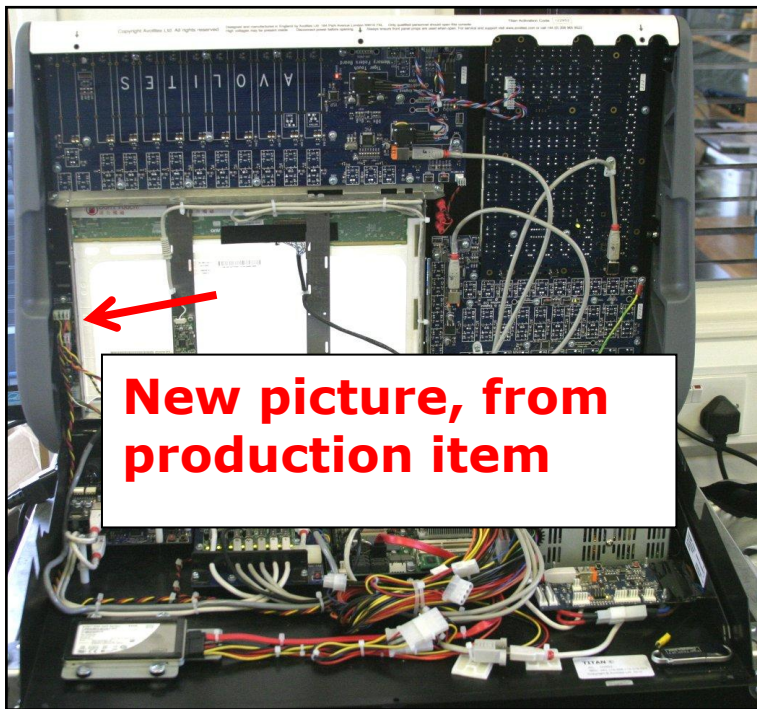

Remove the Power Switch Board from the console. Retain the screws and the washers.



Remove and discard the F3 fuse, and open the hole near the "INV" connector.

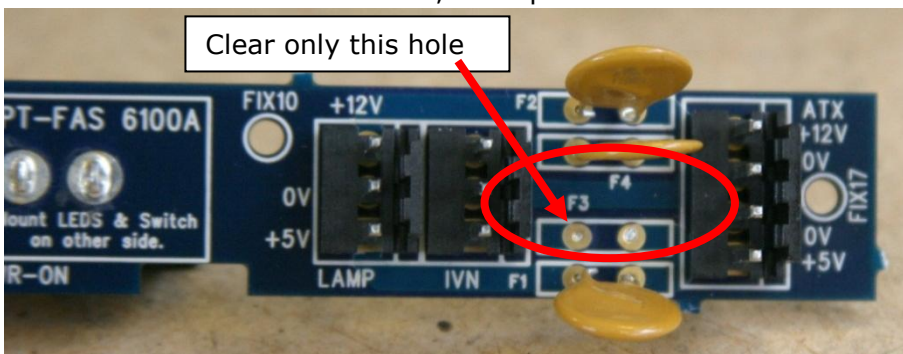

The supplied components will contain a capacitor with a Zener diode connected across its terminals. Ensure that it is oriented as shown in the picture below.

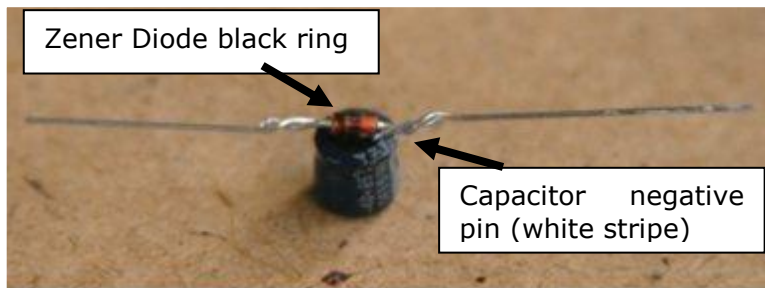

The 10K resistor will have a 1N4148 diode connected across its terminals, as shown below.

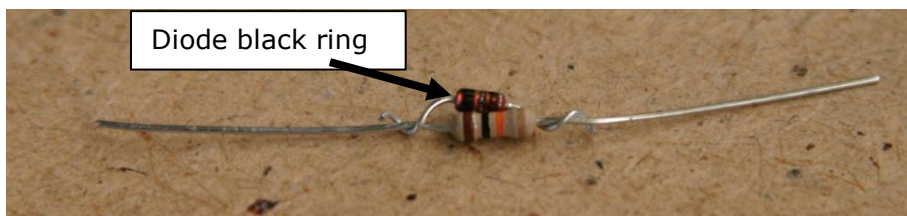

From the switch side, insert the resistor/diode pair into the F3 fuse hole as shown below (black ring towards the 4-way mascon), then solder the resistor to the mascon pin only.

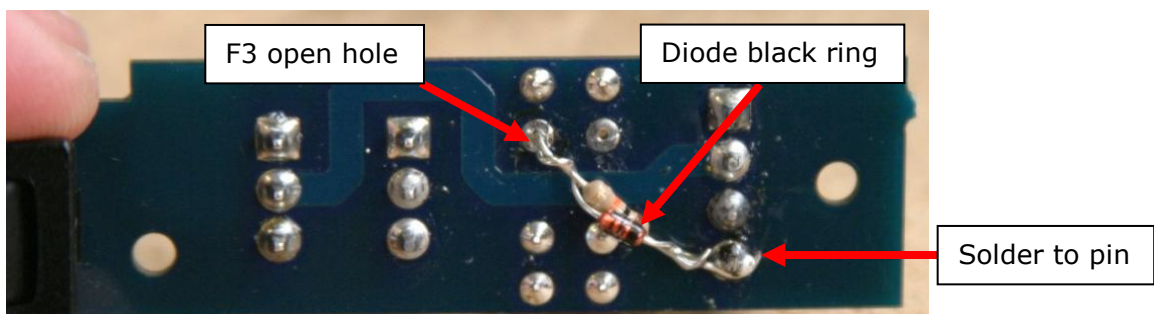

Hook the capacitor "Positive side" under the resistor on the switch side as shown below, then solder the capacitor "Negative side" side to the MASCON 4 pin only as shown.

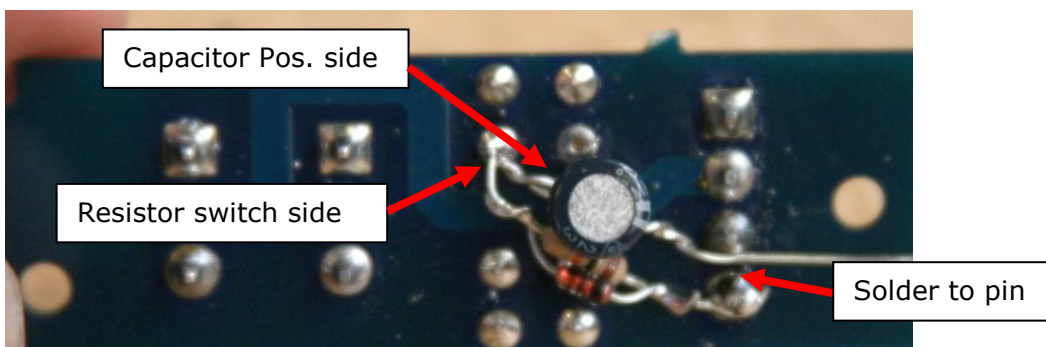

Solder the resistor/diode and the Capacitor/diode pair together and to the board.

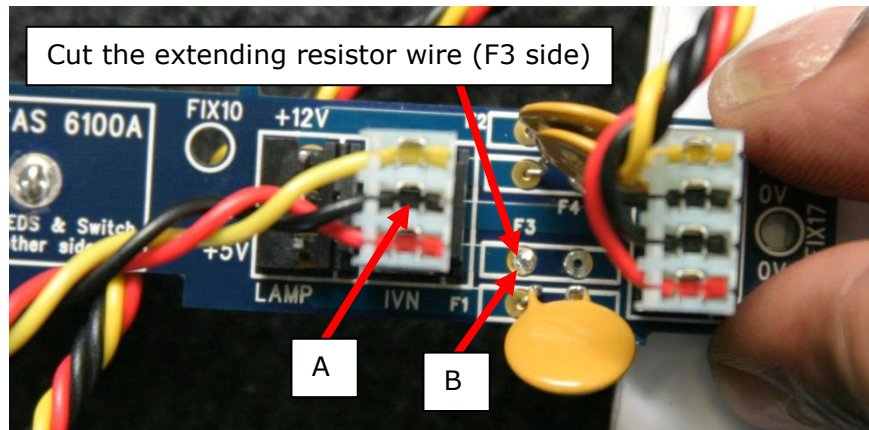
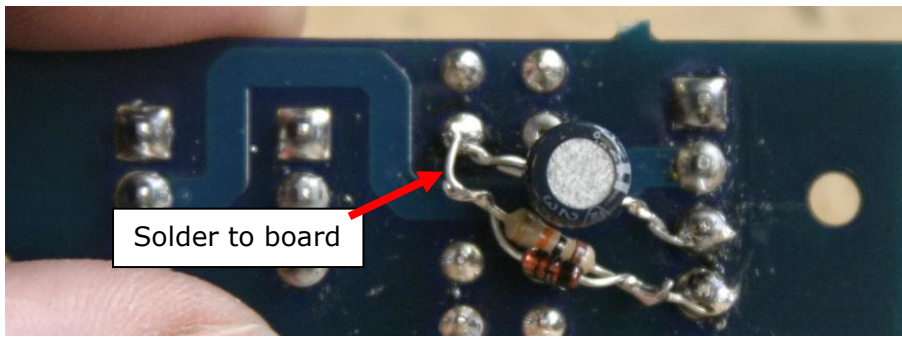

Lightly lift the components off the board so they can not touch.

Refit the board into the console fit the three fixings with nylon washers

Reconnect the cables and secure them as they were previously.

Secure the board to the console with the three screws and washers.

Picture of inside console wiring neat

Switch the console on and observe the inverter to be on, then test the modification by measuring between points A and B (marked on the picture above) there should be about 4.4Vdc between

Close the lid of the console and secure with the three screws.

Note: If the original screws were Torx head screw, you may want to replace them with the supplied M4x8 pan pozi

Test the console multiple times (observe proper shutdown procedure)

Check that the Desk light works.

This concludes the ECN