

Titan v13
User Manual



Useful Avolites phone numbers:-

Avolites England

Sales and service* (+44) (0) 20 8965 8522

Service out of hours* (+44) (0) 7831 178 888

Fax (+44) (0) 20 8965 0290

Email support@avolites.com

Website <http://www.avolites.com>

Before contacting Avolites for service enquiry please ensure that you have the product serial number and the software version. The serial number can be found on the back of the desk; the software version is displayed on the menu prompt when the console is switched to System mode.

The latest version of this manual and console software can be downloaded from the Avolites website.

The small print :

No Liability for Consequential Damages

Avolites has a policy of continuous product and documentation improvement. As such the detail within this manual may not match the operation of the console.

In no event shall Avolites be liable for any direct, indirect, special, incidental, or consequential damages or loss whatsoever (including, without limitation, damages for loss of profits, business interruption, or other pecuniary loss) arising out of the use or inability to use the console even if Avolites Ltd. has been advised of the possibility of such damages. Because some jurisdictions do not allow the exclusion or limitation of liability for consequential or incidental damages, the above limitation may not apply to you.

Avolites Ltd recognise that all trademarks within the manual are the property of their respective owners.

Reprint and revision history:

Titan Universal Manual v13: Feb 2020

Written by Tim Mitchell, Sabre Technology Ltd
<http://www.sabretechnology.co.uk>
with thanks to Nic Morris and Sebastian Beutel

SECTIONS

PRODUCT SAFETY INFORMATION	16
1. QUICK START	20
2. ABOUT THE CONSOLES	24
3. CONNECTING UP AND TITAN BASICS	50
4. PATCHING	86
5. CONTROLLING DIMMERS AND FIXTURES	108
6. PALETTES	140
7. SHAPES AND PIXEL MAPPER EFFECTS	155
8. CUES	197
9. CHASES	225
10. CUE LISTS	237
11. CAPTURE VISUALISER	261
12. SYNERGY AND LINKING TO AI	269
13. RUNNING THE SHOW	283
14. REMOTE CONTROL	306
15. TITAN NET PROCESSOR OPERATION	312
16. SYSTEM MENU AND USER SETTINGS	320
17. FIXTURE PERSONALITIES	341
18. NETWORKING THE CONSOLE	345
19. TITAN COMMANDS QUICK REFERENCE	355
20. INDEX	359



This icon shows important information which you should know about to avoid damage to your console or loss of important data.



This icon shows information which is useful to know.



This icon shows handy tips which will help you use the console more efficiently.

CONTENTS

Product Safety Information	16
1. Quick Start	20
1.1 Patching fixtures.....	20
1.2 Controlling fixtures.....	20
1.3 Programming cues and chases.....	21
1.4 Programming palettes.....	22
1.5 DMX / network setup.....	23
2. About the consoles	24
2.1 Sapphire Touch.....	24
2.2 Arena.....	28
2.3 Tiger Touch.....	32
2.4 Quartz.....	35
2.5 Titan Mobile.....	38
2.6 T1 and T2.....	41
2.7 TNP (Titan Net Processor).....	43
2.8 Pearl Expert and Touch Wing.....	44
2.9 Fader wings.....	48
3. Connecting up and Titan basics	50
3.1 Connecting up.....	50
3.1.1 Cautions.....	50
3.1.2 Connecting mains power.....	50
3.1.3 Starting up and shutting down.....	50
3.1.4 Forced shutdown.....	51
3.1.5 Connecting up Titan Mobile and T1/T2.....	51
3.1.6 Titan Healthcheck.....	52
3.1.7 Connecting DMX lines.....	52
3.1.8 Connecting a monitor.....	53
3.1.9 Other connections.....	54
3.1.10 Connecting console wings.....	54
3.2 Workspace windows.....	54
3.2.1 Opening and positioning workspace windows.....	56
3.2.2 Mini Screen (Arena only).....	60
3.2.3 Saving workspace layout.....	61
3.2.4 Compatibility windows for Pearl Expert shows.....	62
3.2.5 Quick record.....	62
3.2.6 Legends and picture legends.....	62
3.2.7 Button Halo.....	63
3.2.8 Trackball (Sapphire Touch only).....	63
3.2.9 Touch Keyboard.....	64
3.3 Other parts of the touch screen.....	64
3.3.1 The Menu/Softkeys.....	64
3.3.2 The toolbar.....	66
3.3.3 The Heads-Up Display (HUD).....	68
3.3.4 Visualiser.....	69
3.3.5 Undo/Redo.....	69
3.4 Front panel buttons.....	70
3.4.1 Key profiles.....	70
3.4.2 Key macro buttons.....	71
3.4.3 Keyboard shortcuts.....	71
3.4.4 Locking the console.....	73

3.5	Multi-user operation	73
3.5.1	Users.....	73
3.5.2	Handle Worlds	74
3.5.3	Linking to other TitanNet sessions	74
3.6	Titan simulator.....	76
3.6.1	Installing Titan Simulator.....	76
3.6.2	Running Titan Simulator.....	77
3.6.3	Using Virtual Panel with a console	77
3.7	Show Library	77
3.7.1	Show Library tab.....	77
3.7.2	Mapping shows for import.....	78
3.7.3	Users tab.....	78
3.7.4	Key profiles view.....	78
3.8	Loading and saving shows.....	79
3.8.1	Saving the show.....	79
3.8.2	Loading a show.....	80
3.8.3	Importing parts of other shows.....	81
3.8.4	Autosave.....	82
3.8.5	Recover show	83
3.8.6	Backing up existing show files to USB pen drive	83
3.9	Clearing the console	83
3.10	Creating reports	84
4.	Patching	86
4.1	Patching new fixtures or dimmers.....	86
4.1.1	Fixture select buttons and handles.....	86
4.1.2	Patching dimmers	87
4.1.3	Patching moving light fixtures.....	88
4.1.4	Capture Visualiser Auto Patch	91
4.1.5	Patching fixtures with multiple cells (sub fixtures).....	92
4.1.6	Patching Active Fixtures / Media Servers	92
4.1.7	Patching by RDM.....	92
4.1.8	Finding a lost fixture.....	93
4.2	Changing the patch.....	94
4.2.1	Patch View.....	94
4.2.2	View detailed fixture information	95
4.2.3	Changing DMX addressing using Patch View.....	95
4.2.4	Changing DMX address using Patch menu	96
4.2.5	Setting legends	97
4.2.6	Fixture button halo.....	98
4.2.7	DMX view window.....	99
4.2.8	Fixture Exchange.....	99
4.2.9	Exchange Mapping.....	100
4.2.10	Updating patched personalities	102
4.3	Copying, moving and deleting fixtures	102
4.3.1	Copying or moving a patched fixture.....	102
4.3.2	Deleting a patched fixture.....	103
4.4	Fixture personality options	103
4.4.1	Swap pan and tilt	103
4.4.2	Invert attributes.....	104
4.4.3	Attribute limits.....	104
4.4.4	Fixture Offset.....	105
4.4.5	Fixture / Attribute curves.....	105
4.4.6	Freeze fixtures or attributes.....	106
4.4.7	Editing the personality	106
5.	Controlling dimmers and fixtures	108

5.1	Using the select buttons and wheels	108
5.1.1	Selecting fixtures and dimmers for control.....	108
5.1.2	Setting fixtures to a start position (Locate).....	109
5.1.3	Clearing selection.....	110
5.1.4	Fixtures with multiple cells/subfixtures.....	111
5.1.5	Changing attributes using the wheels.....	112
5.1.6	Attribute wheel display	114
5.1.7	Attribute editor window	114
5.1.8	Setting attributes from the softkeys.....	119
5.1.9	Adjusting attributes with the @ buttons.....	120
5.1.10	Selecting fixtures and dimmers by number (Channel).....	120
5.1.11	Selecting fixtures using a pattern.....	121
5.1.12	Selecting fixtures which are in a playback.....	123
5.1.13	Attribute groups – IPCGBES-FX.....	123
5.1.14	Stepping through selected fixtures one at a time.....	124
5.1.15	Highlighting the selected fixture with Prev/Next.....	124
5.1.16	Turn off unselected fixtures (Remainder Dim).....	124
5.1.17	Align fixtures.....	124
5.1.18	Flip.....	125
5.1.19	Fan mode.....	125
5.1.20	Setting fixture/attribute times.....	130
5.1.21	Clearing attributes using "Off".....	130
5.2	Viewing and editing fixture values.....	131
5.2.1	The Channel Grid window	131
5.2.2	Intensity window.....	132
5.3	Fixture groups.....	134
5.3.1	Using fixture groups.....	134
5.3.2	Fixture Order and Fixture Layout in groups.....	135
5.4	Advanced options.....	137
5.4.1	The ML Menu button	137
5.4.2	Lamping fixtures on and off.....	138
6.	Palettes	140
6.1	Creating palettes.....	141
6.1.1	Which attributes are stored in palettes.....	141
6.1.2	Storing a palette.....	141
6.1.3	Nested palettes.....	144
6.1.4	Quick record.....	144
6.1.5	Setting legends for palettes.....	145
6.1.6	Creating an effects palette (shape or pixel mapper).....	146
6.1.7	Creating a time palette.....	147
6.2	Using palettes.....	147
6.2.1	Recalling a palette value.....	147
6.2.2	Palette pages.....	148
6.2.3	Only showing relevant palettes.....	148
6.2.4	Quick palettes with no fixtures selected.....	148
6.2.5	Setting palettes to all fixtures in a playback.....	148
6.3	Editing palettes.....	149
6.3.1	Viewing and editing the content of palettes.....	149
6.3.2	Changing the content of palettes.....	149
6.3.3	Updating palettes used in a playback.....	150
6.4	Copying, moving and deleting palettes.....	150
6.4.1	Copying or moving a palette.....	150
6.4.2	Deleting palettes.....	151
6.5	Timing with palettes.....	151
6.5.1	Palettes with saved times.....	151
6.5.2	Manually overriding palette times.....	152
6.5.3	Manual fixture overlap when recalling palettes.....	152

6.5.4	Master Time for palettes	152
7.	Shapes and Pixel Mapper effects	155
7.1	Shape generator	155
7.1.1	Selecting a shape	156
7.1.2	Changing size and speed of a shape	157
7.1.3	Changing the spread of a shape across multiple fixtures	158
7.1.4	Shape direction	159
7.1.5	Beat and cycles	159
7.1.6	Using shapes in cues	160
7.1.7	Storing shapes in Palettes	160
7.2	Key frame shapes	160
7.2.1	Creating a key frame shape	160
7.2.2	Changing shape parameters in the Effect Editor	161
7.2.3	Saving a key frame shape to a cue	166
7.3	Pixel mapper	167
7.3.1	Creating Pixel Mapper effects	167
7.3.2	Pixel mapper Layer Masters	172
7.4	Editing shapes and effects	172
7.4.1	Editing a live running shape	172
7.4.2	Editing shapes and effects in cues	173
7.4.3	Editing a shape in a cue using include	173
7.4.4	Resynchronise shapes	173
7.4.5	Changing fixture order in a shape	173
7.4.6	Shapes linked to Groups	174
7.4.7	Removing or adding fixtures	174
7.4.8	Reversing a shape	174
7.4.9	Deleting shapes	174
7.5	Advanced options	174
7.5.1	Fading shape size and speed	174
7.6	Pixel Mapper examples	175
7.6.1	Randomising effects	175
7.6.2	Overlaying effects	179
7.6.3	Creative use of fixture layouts	181
7.6.4	Other Layout Editor tools	185
7.6.5	Playback Order and Priorities	186
7.6.6	Displacement and Layer Properties	190
7.6.7	Spawn and Pre-Spool	193
8.	Cues	197
8.1	Creating a cue	197
8.1.1	How Titan works when programming	197
8.1.2	Creating a cue	198
8.1.3	Quick Build cues	199
8.1.4	Using shapes/effects in cues	199
8.1.5	Blind mode	199
8.1.6	Recording cue with a mask	199
8.1.7	Convert cue to chase or cue list	200
8.2	Using a cue	200
8.2.1	Combining cues with HTP and LTP	200
8.2.2	Playing back a cue	200
8.2.3	Changing playback pages	201
8.2.4	Viewing active playbacks	202
8.2.5	Speed and Size Masters	202
8.2.6	Releasing running playbacks	202
8.2.7	Releasing a whole page of playbacks	203
8.2.8	Release mask - releasing individual attributes	203
8.2.9	Programming the Release / Power On state	204

8.2.10	Auto Run playbacks on power up.....	204
8.2.11	Turning off individual fixtures.....	205
8.3	Playback groups.....	205
8.3.1	Creating a Playback Group.....	205
8.3.2	Editing which playbacks are in a Playback Group.....	206
8.3.3	Playback Group options.....	206
8.3.4	Playback Group Workspace display options.....	207
8.4	Editing cues.....	209
8.4.1	Editing a cue by merging.....	209
8.4.2	Updating stored values and palettes used in a cue.....	209
8.4.3	Playback and Cue view.....	210
8.4.4	Using parts of existing cues - the Include function.....	212
8.4.5	Removing attributes from cues using "Off".....	212
8.5	Copying, moving, linking and deleting.....	213
8.5.1	Copying or moving a cue.....	213
8.5.2	Deleting a cue.....	214
8.6	Cue timing.....	214
8.6.1	Setting fade times and Overlap for a cue.....	214
8.6.2	Changing fixture order.....	217
8.6.3	Setting attribute fade times for a cue.....	217
8.6.4	Editing times in the programmer.....	218
8.7	Playback options.....	219
8.7.1	Playback options – Playback tab.....	220
8.7.2	Playback options – Handle TAB.....	221
8.7.3	Playback options – Fader tab.....	222
8.7.4	Playback options – Effects tab.....	222
8.7.5	Playback options – Release tab.....	222
9.	Chases	225
9.1	Creating a chase.....	225
9.1.1	Programming a chase.....	225
9.1.2	Creating a chase with Quick Build.....	226
9.2	Playback.....	226
9.2.1	Playing back a chase.....	226
9.2.2	Connecting a chase for control.....	227
9.2.3	Setting speed and crossfade for a chase.....	227
9.2.4	Manually controlling the steps of a chase.....	228
9.2.5	Changing chase direction.....	229
9.2.6	Jumping to a step.....	229
9.3	Editing a chase.....	229
9.3.1	Opening a chase for editing.....	229
9.3.2	Editing a chase using Unfold.....	230
9.3.3	Extracting a step from a chase with Include.....	230
9.4	Copying, moving, linking and deleting.....	230
9.4.1	Copying or moving a chase.....	230
9.4.2	Deleting a chase.....	231
9.4.3	Deleting a step from a chase.....	231
9.5	Chase timing.....	231
9.5.1	Global timings for chases.....	231
9.5.2	Individual cue times in chases.....	232
9.5.3	Setting attribute fade times for a cue in a chase.....	233
9.5.4	Rate and BPM masters.....	234
9.5.5	Speed Multipliers.....	234
9.6	Chase options.....	234
9.6.1	Chase options – Playback tab.....	235
9.6.2	Chase options – Handle tab.....	235
9.6.3	Chase Options – Effects tab.....	235

9.6.4	Chase Options – Release tab.....	235
9.6.5	Renumber All Cues.....	235
10.	Cue Lists	237
10.1	Creating a cue list.....	237
10.1.1	Programming a cue list.....	237
10.1.2	Changing legends for cues in a cue list.....	238
10.1.3	Shape tracking in cue lists.....	239
10.1.4	Autoloading a playback within a cue list.....	239
10.1.5	Running a key macro from a cue list.....	240
10.1.6	Keyboard shortcuts/syntax for cue lists.....	241
10.2	Cue List playback.....	241
10.2.1	Running a cue list.....	241
10.2.2	Killing a cue list.....	243
10.2.3	Tracking.....	243
10.2.4	Move In Dark (MID) functions.....	244
10.2.5	Key profile options for Cue Lists.....	244
10.3	Editing cue lists.....	245
10.3.1	Playback View window.....	245
10.3.2	Editing values in Cue View window.....	245
10.3.3	Moving and copying cues.....	246
10.3.4	Editing a cue list using Unfold.....	247
10.3.5	Using Update to change tracked cues.....	247
10.3.6	Editing a cue list which is running.....	248
10.3.7	Editing a cue list while recording.....	249
10.3.8	Updating values in a range of cues.....	249
10.3.9	Disabling a cue.....	249
10.3.10	Extracting a cue from a cue list with Include.....	250
10.4	Copying, moving, linking and deleting.....	250
10.4.1	Copying or moving a cue list.....	250
10.4.2	Deleting a cue list.....	250
10.4.3	Moving a cue in a cue list.....	250
10.4.4	Deleting a cue from a cue list.....	250
10.5	Cue list timing.....	251
10.5.1	Time and fade options for Cue Lists.....	251
10.5.2	Cue linking & Link Offset.....	251
10.5.3	Individual attribute fade times.....	252
10.5.4	Fixture overlap.....	253
10.5.5	Running a cue list to timecode.....	254
10.6	Cue list options.....	255
10.6.1	Cue List options – Playback tab.....	256
10.6.2	Cue list options – Handle tab.....	256
10.6.3	Cue list options – Fader tab.....	256
10.6.4	Cue list options – Effects tab.....	256
10.6.5	Cue list options – Release tab.....	256
10.6.6	Renumber all cues.....	257
10.6.7	Cue Options.....	257
10.7	Theatre programming quick guide.....	257
11.	Capture visualiser	261
11.1	Setting up the rig.....	261
11.1.1	Setting up the stage and rigging.....	261
11.1.2	Setting up fixtures.....	262
11.1.3	Setting up cameras (views).....	263
11.1.4	Capture Appearance options.....	264
11.2	Visualising using Capture.....	265
11.2.1	Fixture selection.....	265
11.2.2	Camera views.....	265

11.3	Capture Show files.....	265
11.3.1	Exporting shows.....	266
11.3.2	Importing shows.....	266
11.3.3	Clearing the capture show.....	266
11.4	Linking the console to stand-alone Capture.....	266
11.4.1	Patching console fixtures into Capture.....	267
11.4.2	Patching Capture fixtures onto the console.....	267
12.	Synergy and Linking to AI	269
12.1	Setting up.....	269
12.1.1	Connecting up.....	269
12.1.2	Setting up the AI show.....	269
12.1.3	Synergy setup.....	269
12.1.4	Synergy fixtures window.....	272
12.2	Operating Synergy.....	273
12.2.1	Uploading content with the Media browser.....	273
12.2.2	Media viewer.....	274
12.2.3	Attribute editor for controlling Ai layers.....	276
12.2.4	Lightmap: Pixel mapping Ai media content.....	278
12.2.5	Layout editor with Ai server.....	279
12.2.6	Phase control of Keyframe Shapes from Ai.....	281
12.2.7	Special function bank/clip numbers.....	281
13.	Running the show	283
13.1	Playback controls.....	283
13.1.1	Back up the show.....	283
13.1.2	Label the console.....	283
13.1.3	Grand Master fader and assignable masters.....	283
13.1.4	Speed and Size Masters.....	284
13.1.5	Playback Groups.....	286
13.1.6	Fixture Group Masters.....	286
13.1.7	Scene Master.....	287
13.1.8	Flash and swop buttons.....	288
13.1.9	Playback priority.....	289
13.1.10	Preset playbacks (Tiger Touch only).....	289
13.1.11	Locking a playback onto the same handle on every page.....	289
13.1.12	Viewing active playbacks.....	289
13.1.13	Blind mode.....	290
13.1.14	Busking with palettes.....	290
13.2	Using multiple on-screen workspaces.....	291
13.2.1	View menu.....	291
13.3	Organising the console.....	292
13.3.1	Using the Move function.....	292
13.4	Set List window.....	292
13.4.1	Creating a Set List.....	293
13.4.2	Configuring tracks.....	293
13.4.3	Track Workspace and Macro links.....	294
13.4.4	Playback control Macros.....	294
13.5	External triggering.....	295
13.5.1	Connecting external trigger sources.....	295
13.5.2	Setting up external triggering.....	295
13.5.3	MIDI show control.....	297
13.5.4	Audio control (sound to light).....	298
13.6	Linking PioneerDJ system to Titan.....	299
13.6.1	Connecting Titan to the Pioneer system.....	299
13.6.2	Pioneer workspace window.....	301
13.6.3	Setting up BPM triggers from Pioneer.....	302

13.7	Linking consoles for multi-user or backup	303
13.7.1	Setting up consoles for multi-user	303
13.7.2	Setting up consoles for backup.....	303
14.	Remote control	306
14.1	Setting up the remote	306
14.1.1	Using an existing network	307
14.1.2	Network setup using a dedicated access point.....	307
14.2	Operating the remote.....	308
14.2.1	Keypad.....	308
14.2.2	Controlling fixtures	309
14.2.3	Recording groups and palettes	310
15.	Titan Net Processor operation	312
15.1	TNP Slave mode.....	312
15.1.1	Setup	313
15.1.2	Locking the TNP.....	314
15.1.3	Tools	314
15.2	TNP console mode	315
15.2.1	Running Playbacks.....	315
15.2.2	Setting the View.....	315
15.2.3	Locking the panel	316
15.2.4	Loading and saving shows, and other Setup.....	317
16.	System Menu and User Settings	320
16.1	The System menu	320
16.1.1	Network Settings	320
16.1.2	DMX settings.....	320
16.1.3	DMX Merge Settings.....	320
16.1.4	SYNERGY Settings.....	320
16.1.5	TitanNet Security.....	320
16.1.6	User Settings.....	320
16.1.7	Key Profiles.....	321
16.1.8	Wipe.....	321
16.1.9	Triggers.....	321
16.1.10	Assign masterS.....	321
16.1.11	Console Legend.....	321
16.1.12	Titan Telemetry.....	321
16.1.13	Display Setup.....	321
16.2	External displays.....	321
16.3	Key Profiles	322
16.3.1	Creating and editing key profiles	322
16.3.2	Selecting a Key Profile.....	324
16.3.3	Individual Key profiles for playbacks.....	324
16.4	User Settings.....	324
16.4.1	General.....	325
16.4.2	Handles.....	326
16.4.3	Key Profiles.....	326
16.4.4	Patching	326
16.4.5	Times.....	327
16.4.6	Formatting.....	327
16.4.7	Palettes	327
16.4.8	Release.....	328
16.4.9	Clear.....	328
16.4.10	Effects.....	328
16.4.11	LEDs.....	329
16.4.12	Timecode.....	329
16.4.13	Wheels.....	329

16.5	DMX output mapping.....	330
16.5.1	Configuring DMX outputs.....	330
16.5.2	Module Properties.....	331
16.5.3	DMX Overview.....	333
16.5.4	DMX merge.....	334
16.6	Curves.....	334
16.7	Upgrading the software.....	338
16.8	Recovering/reinstalling the console.....	339
16.8.1	Installation Instructions.....	339
16.8.2	Software licensing.....	340
16.9	Release notes.....	340
17.	Fixture Personalities	341
17.1.1	Downloading fixture personalities from Avolites.....	341
17.1.2	Updating the personality library on the console.....	342
17.1.3	User/custom personalities.....	342
17.1.4	Requesting a new fixture personality.....	343
17.1.5	Reporting a personality bug to Avolites.....	343
17.1.6	In an emergency.....	343
18.	Networking the console	345
18.1	Connecting the Arena to a network.....	345
18.1.1	Optical connections.....	345
18.1.2	Wired ethernet outputs.....	345
18.1.3	Changing the IP address of the network switch (TNS).....	346
18.1.4	Power and UPS behaviour.....	347
18.2	Controlling fixtures over a network.....	347
18.2.1	Setting the console's IP address.....	347
18.2.2	Setting up DMX outputs.....	347
18.2.3	A simple Art-Net system.....	347
18.2.4	Setting up an Art-Net system.....	349
18.2.5	Additional Art-Net Resources.....	350
18.3	Using Active Fixtures with CITP.....	350
18.3.1	Example CITP setup.....	351
18.4	A quick guide to IP addressing.....	351
18.4.1	Setting your IP address.....	351
18.4.2	Subnet Masks.....	352
18.4.3	Choosing an IP address and Subnet Mask.....	352
18.4.4	Automatically assigning IP addresses (DHCP).....	353
18.4.5	Private IP address ranges.....	353
19.	Titan Commands quick reference	355
19.1.1	Fixtures.....	355
19.1.2	Select If.....	356
19.1.3	Record.....	356
19.1.4	Copy, Move in cue list.....	357
19.1.5	Delete.....	357
19.1.6	Include.....	357
19.1.7	Times.....	357
19.1.8	Cue Lists.....	358
20.	Index	359

Dear Customer,

Thank you for buying an Avolites product. A lot of time and energy has gone into the development and manufacture of this product, so we really hope that you enjoy using it.

We have developed some resources to ensure that you get the most from your Avolites product.

Training

Titan Webinars - free online webinars every Thursday with Q&A sessions, which are recorded and can be watched at Avolites.com/training if you can't attend

Training - beginner and advanced Titan training sessions, including a goodie bag, a tour of head office and lunch. Bespoke training sessions can be arranged for Ai

Tutorials - there are tutorials on almost every topic on our YouTube channel in multiple languages
To find out more, please email training@avolites.com or visit Avolites.com/training.

Avolites Forums

Post a question or search for an answer on any Avolites product - forum.avolites.com

Facebook User Groups

There are many Avolites user groups on Facebook in different countries and languages, but the most active groups are; Avolites Programmers and Users (search on Facebook), and Titan One Programmers and Users (search on Facebook).

Personality Files

Download the latest set of personality files for your console, if you can't find the personality you need you can also request it on the same page - personalities.avolites.com

Monthly Newsletter

Visit avolites.com/newsletters to view past newsletters and sign up.

Licensing

We always strive to look after our customers, so protect your investment in our products we have implemented a licensing system to guard against counterfeit consoles.

If you have any licensing issues please contact software support, shown below.

Support

Titan Support:

Software - +44 (0)208 955 9232 (10am - 6pm UK)

Hardware - +44 (0)208 955 9230 (10am - 6pm UK)

Urgent Out of Hours - +44 (0)7831 178 888

Titan One - forum.avolites.com

Ai Support:

aisupport@avolites.com

+44 (0)208 965 8522 (10am - 6pm UK)

Urgent Out of Hours - +44 (0)7415 066 915

Happy programming,



The Avolites Directors

PRODUCT SAFETY INFORMATION

Please read the following text regarding product safety information

PRODUCT WEIGHTS AND SAFETY

- Take care when lifting the product, see approximate product weights and handling guide below

Product	Approximate product weight	Approximate weight in Avolites flight-case	Handling instructions
Quartz	11 Kg / 25 lbs	20 Kg / 44 lbs	
Tiger touch 2	20 Kg / 44 lbs	32.5 Kg / 72 lbs	Take care when lifting
Arena	23 Kg / 51 lbs	21 Kg / 47 lbs	Two person lift
Sapphire	51 Kg / 113 lbs	85 kg / 188 lbs	Two person lift
TNP	15 Kg / 33 lbs	NA	

ENVIRONMENTAL MAXIMUMS

- Do not operate the consoles if the humidity and ambient temperature cause condensation on the product, allow the product to dry first before connecting to the mains.
- Max humidity is 95% relative humidity non-condensing
- Operating temperature range 0-40 °C or 32-104°F
- Storing temperatures -15- 50°C or 5-122°F

ELECTRICAL SAFETY

- All Avolites mains operated consoles must be connected to protective earth (PE) when energized.
- Do not use the product if the mains inlet is damaged
- Do not use the product if the mains system is not in accordance to the below information
- Do not open the product while connected to mains unless qualified to do so.

MAINS VOLTAGES:

- The minimum and maximum voltage ratings are:
 - 90-240V AC ±10%
 - Single phase with the following connections: Phase, Neutral and PE (protective earth)
- Mains frequency 50-60hz ±10%

POWER CONSUMPTION:

Product	Power	Currents @ 110~240V
Quartz	40 W	2.5~1A
Tiger touch 2	100W	5~2.5A
Arena	130W	5~2.5A
Sapphire	250W	5~2.5A
TNP	80W	5~2.5A

UPS BATTERY

The TT2, Arena, TNP and Sapphire products contain a Sealed Lead Acid battery for the UPS. Observe the following safety precautions when handling the batteries

- Do not short the terminals of the lead acid battery.
- Do not cover the vent hole
- Do not use the product with a damaged UPS battery
- Do not alter the charging circuit or charge the battery from an external source
- Replace the lead acid battery with the correct type see below

Product	Fitted battery	Avolites PN
Tiger touch 2	12V 3.4 AH	11-03-0092
Arena	12V 3.4 AH	11-03-0092
Sapphire	2x 12V 3.4 AH	11-03-0092
TNP	12V 3.4 AH	11-03-0092

UPS BATTERY CARE AND MAINTENANCE

- The Ups battery is a consumable and in most cases needs to be replaced every 3 years, however this depends on the usage and environmental conditions of the console.
- Allow the UPS to run of the battery at least once every 2 months of usage to prevent reduction in capacity due to crystallization process inside lead acid batteries.
- If the battery is damaged take care not to touch the acid gel or parts that may have acid gel on them.
- If the battery terminals are corroded replace the battery and fit new terminals
- Recycle the UPS battery in accordance with local law

CMOS BATTERY

The product motherboard contains a Lithium Ion button cell for CMOS data retention.

This battery is used to maintain CMOS data when the product is not powered, this battery will need to be replaced at least every five years. If the product is mostly off for long periods or in cold environments then it may need an earlier replacement.

Product	PN
Quartz	11-03-0018
Tiger touch 2	11-03-0017
Arena	11-03-0017
Sapphire	11-03-0017
TNP	11-03-0017

Recycle the CMOS battery in accordance with local law

Please be aware that Lithium ion button cells are a particular danger to small children.

TOUCH SENSOR GLASS SAFETY

Do NOT operate the console if the touch sensor is broken as glass particles may be released by the sensor.

SERVICING THE PRODUCT

- Leave repairs and service to qualified personnel.
- Hazardous voltage may be present inside the PSU for up to one minute
- Do not operate the Quartz console without the PSU cover.
- Replace safety critical parts like PSU, Battery, Fuses and Mains Connectors with original parts.
- Take care when replacing the battery to not short the outputs of the battery or UPS board connections
- Take care not to obstruct the CPU or PSU fan



I. QUICK START

This section is a quick guide on how to do most things on Avolites Titan consoles. Each section has a link to take you to the appropriate manual section for more details.

Softkeys (the A-G menu buttons next to the screen) are shown in square brackets like [This]. Physical labelled buttons on the console are shown like <This>.

1.1 PATCHING FIXTURES

Press <Patch>, [Dimmers] or [Fixtures].

For Fixtures, from the softkeys choose fixture manufacturer (type on keyboard to filter the list) then fixture type, then fixture mode.

Set [DMX Line] and [Address]. Console will automatically set these if you don't change them.

Press buttons in the Fixtures window to patch the fixture, or patch fixtures on faders (except the main playback faders) by pressing the blue select button (Section 4.1.3, p88).

To patch a number of dimmers or fixtures at once, draw a selection box over buttons on the screen, or on physical buttons hold down first select button and press last in range. Or, set [Quantity] in the patch menu.

To change DMX address or line, use [Repatch Fixtures]. (Section 4.2, p94).

VIEW FIXTURE PATCH

To see an overview screen of how the console is patched, press <View/Open> then <Patch> (Section 4.2.1 , p94).

SETTING FIXTURE OPTIONS

Press <Patch>, [Edit Fixtures], or use the Patch View screen.

1.2 CONTROLLING FIXTURES

Select fixtures for control by pressing select buttons. Fixture buttons turn blue when selected.

Press <Locate> to "home" selected fixtures with lamp on. If fixture is patched on a fader, the fader controls the dimmer. (Section 5.1.2. p109). Hold <Locate> and press attribute button to remove that attribute from the locate (e.g. to locate without changing pan/tilt, hold <Locate> and press <Position>).

Select attribute to control using attribute bank buttons (labelled Intensity/Dimmer, Colour, Gobo etc), then turn the wheels to set fixture. Display shows which attribute each wheel is controlling. (Section 5.1.5, p112).

Open Attribute window onscreen (<View/Open> then one of the attribute bank buttons such as <Position> or <Intensity>) to select attributes from buttons and to control subfixtures of battens/arrays. (Section 5.1.4, p111).

Use Palettes to store often-used colours, positions etc. for instant recall, see next page.

FIXTURE GROUPS

Fixtures may be grouped for quick selection, press <Group>, [Record Group], select fixtures for group, set legend using [Provide a legend], press a handle to store. If the handle has a fader it becomes a master fader for the group. Order of fixture selection is remembered for use with shapes. (Section 5.3.1, p134). Physical layout of fixtures in group can also be set for use with pixel mapper or shapes.

Shapes / effects

Titan can use preset shapes, patterns you create yourself (key frame shapes) or pixel mapped patterns.

Select fixtures. The order in which you select the fixtures is used by shapes.

At top menu press [Shapes and Effects], [Shape Generator], [Create]. Select attribute of shape then select a shape to run. (Section 7.1.1, p156).

Or from the Shape Library window (<Open/View>, [Open Workspace Window], [Shape Library]) you can select a shape directly. Filter the list of shapes using the attribute buttons.

Use the wheels and [Adjust Speed, Size and Spread]/[Adjust Phase, Spread and Offset] to configure the shape. Spread distributes the shape across a number of fixtures.

Key frame shapes are similar to a chase but you can spread the sequence across fixtures (Section 7.2, p160).

To use Pixel Mapper, save fixtures to a group, select the group. Use Layout Editor to set the real-world layout of the fixtures. Then use Effects Editor to create effects on the pixels. (Section 7.6, p175).

1.3 PROGRAMMING CUES AND CHASES

CUES

Set up the look to be recorded.

Press <Record>.

Set [Record Mode] to [Channel] (saves only modified attributes), [Fixture] (saves all attributes of fixtures which have been modified or are selected), [Stage] (saves all attributes of all fixtures with nonzero dimmer), or [Quick Build] (merges palettes and playbacks into the cue when you select them).

To store, press a blue Select button on fader, or press button in Playbacks window. (Section 8.1.2, on p198).

CHASES

Press <Record> twice (or <Record> then [Create Chase]).

Press blue Select button on a fader, or press button in Playbacks window.

Set up the look for the first step, press playback select button to store. Repeat until all steps stored. Quick Build mode can be used to merge palettes and cues into chase steps.

Press <Exit> to finish storing chase steps. (Section 9.1.1, p225).

TIMINGS

All times (cue times and fixture attribute times) are stored in the programmer and are saved when you store a cue.

To edit times in the programmer before saving, press the <Times> button (previously labelled <Set> on Quartz/Titan Mobile/Sapphire Touch/Tiger Touch and <Next Time> on Pearl Expert/Tiger Touch mk1).

For chases, speed and fade can be set with wheels A and B when the chase is running.

To edit times in a saved cue, at top level menu press [Edit Times] then the select button for the playback. Timing options are set from softkeys.

[Fixture Overlap] sets each fixture to fade in sequence (100%=all together, 0%=fixture waits for previous one to complete).

[Attribute times] sets individual fade times for different attributes.

[Fixture order] changes sequence for shapes and Overlap. (Section 9.5, p231).

CUE LISTS

Cues may be stored in a Cue List which allows a full show to be run from a Go button. Chases can be included using Autoload. Cue lists can run in tracking or non-tracking mode, set from [Playback Options].

1.4 PROGRAMMING PALETTES

Set up the attributes to be recorded. If attribute is the same for all fixtures of one type (e.g. colour), only one fixture need be set up and palette will be “shared”.

Press <Record>, <Palette> (See also Quick Record below).

Use [Set Mask] to choose attributes to record/exclude. If you are storing in a palette touch button the mask is automatically set.

Press a grey handle button to store (except on the main playbacks), or touch a button in one of the Colours/Positions/Gobos windows. (Section 6.1.2, p141).

To recall palette, select fixtures, select recall mask using Attribute Bank buttons, press palette button.

To set a legend, press [Set Legend] then the palette’s button. Press [Picture] to draw a picture legend.

QUICK RECORD

Press an unused button in one of the palette windows – the button turns red with a +. Press again to save the palette. The mask is automatically set to match the window (e.g. Positions window is masked for only position attributes).

BUSKING WITH PALETTES

To fade palettes when busking a show, select fixtures, type fade time on the keypad then recall the palette (you have to do this each time). If no fixtures selected, palette will recall to all

applicable fixtures (called a Quick Palette. – Quick Palettes do not go into the programmer so don't use when programming).

To set fixture overlap, type 0-100 then press [Set Overlap], then recall the palette.

To set a fade time for all palettes, press Palette then [Master Time]. (Section 6.5, p151).

1.5 DMX / NETWORK SETUP

The console can output up to 16 universes of DMX (called DMX Lines) which may be routed to the XLR sockets on the console or over Ethernet (The T1 dongle is limited to a single universe, T2 to 2 universes.) By connecting further Titan Network Processors (TNP) to the network using TitanNet, you can control up to 64 universes.

Multiple consoles can be linked by Ethernet to provide a multi-user system, or to provide automatic backup (Section 13.7, p303).

Switch to System mode (hold <Avo>, press <Disk>), press [DMX Settings].

Select a Node on the left (where the DMX is going to), click the blue arrow. On the right, select the DMX line it will be fed by. The 'i' buttons set properties for Nodes/Lines. (Section 6.5, p330).

To change the IP address of the console, press [Network Settings] in System mode (Section 18.2.1, p347).

To change User Settings which let you personalise how the console works, hold down <Avo> and select [User Settings] (Section.16.1.6, p320).

2. ABOUT THE CONSOLES

This manual is a reference guide to all the functions of Titan consoles.

We explain things in the order you're most likely to use them, so we start with how to set up the console, then look at patching lights, controlling lights and how to program cues.

As this manual covers all types of console, this section has details about each individual console design in turn; where the controls are and where the connections are.

2.1 SAPPHIRE TOUCH



The Sapphire Touch has four main control areas:

The two **Touch screens** contain fixture, palette and group select buttons. They also show legends for the playback faders and shows the current menu page and softkey buttons on the top right of the right hand screen.

The **Playback faders** select and control cues and programs

The **Preset playbacks** are used for patching fixtures or for additional playbacks.

The **Programming and setup controls** configure and program the console and the **macro/executor buttons** allow storage of frequent key sequences, screen layouts, groups or programs.

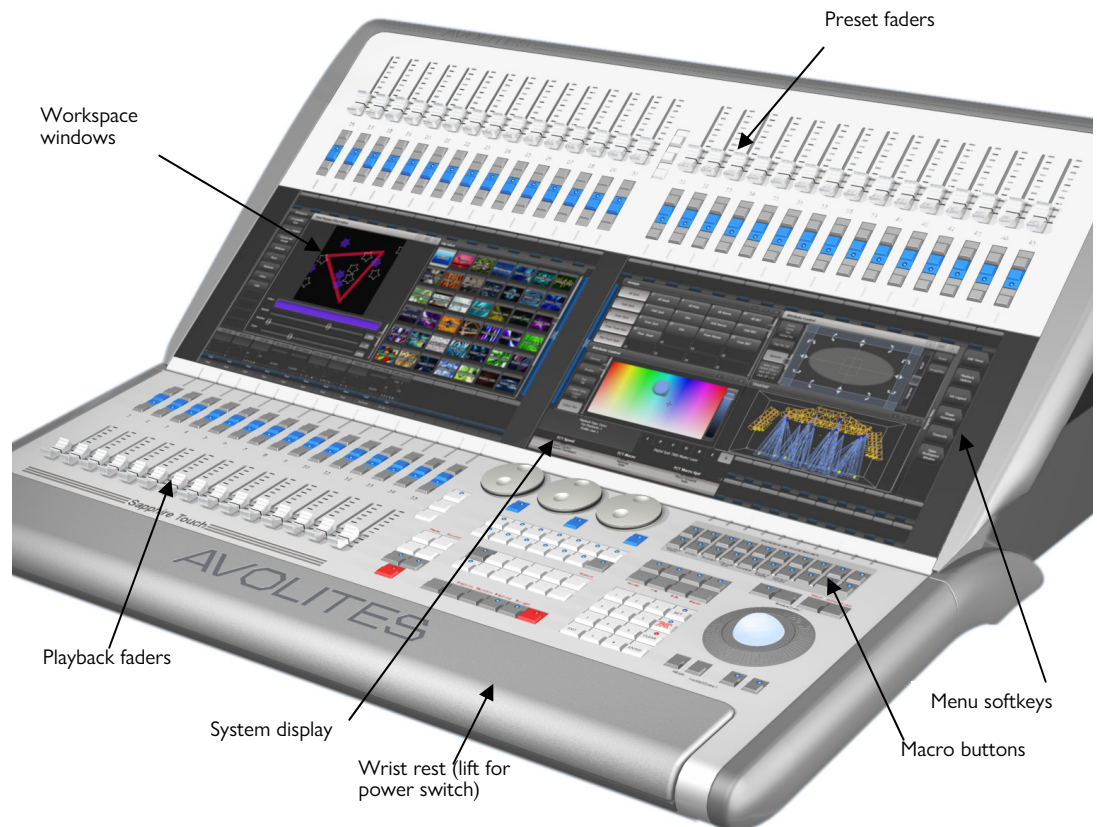

The main controls

The **Workspace windows** on the touch screens contain touch buttons for fixtures, palettes, groups, playbacks, macros and more. You can also set fixture attributes and show information windows.

The **System display** area of the touch screen is the nerve centre of the console and shows you what is going on. This part of the display shows various screens of information depending on what you are currently doing.

The **Menu Softkeys** (labelled A – G) are used to select control options. The options for each key change depending on what the console is doing. Softkey commands are shown in the manual with square brackets like this: [Edit Times]

The **Preset Faders** at the top are used to patch fixtures, and store and play back cues or chases. The **Preset Page Select buttons** in the centre of the faders let you change to a different page.

The **Macro Buttons** store frequently used sequences of keypresses which can be replayed with a single button press. Playbacks can also be stored here. The display immediately above the buttons shows legends for the buttons

The **Playback faders** are used to store and play back cues or chases. The **Playback Page Select buttons** let you change to a different page of playbacks. The touch screen above the faders shows information about each playback.

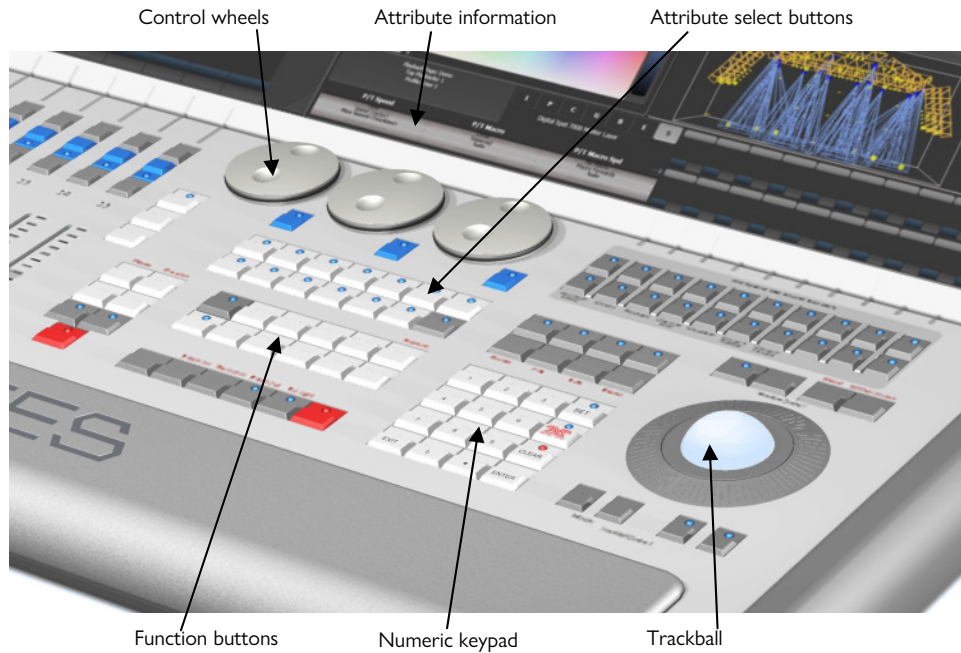

The **Control wheels** are used to set control values (attributes) for the fixtures, and to set chase speeds and fades. The touch screen above the wheels shows information about the attributes being controlled.

The **trackball** controls pan and tilt of fixtures, and can also be used to control the mouse pointer for the screens.

The **Numeric keypad** and other control buttons are used to enter values and change controls on the console.

The **Function buttons** are used to carry out functions such as storing cues, copying, patching, saving to disk, etc.

The **Attribute select buttons** are used to select which attributes of a fixture (e.g. colour, gobo, pan, focus) are going to be controlled using the Control wheels. The buttons have lights on to show you which attributes are active. The bottom (red) button allows you to locate fixtures, which sets them to a known start position while programming.

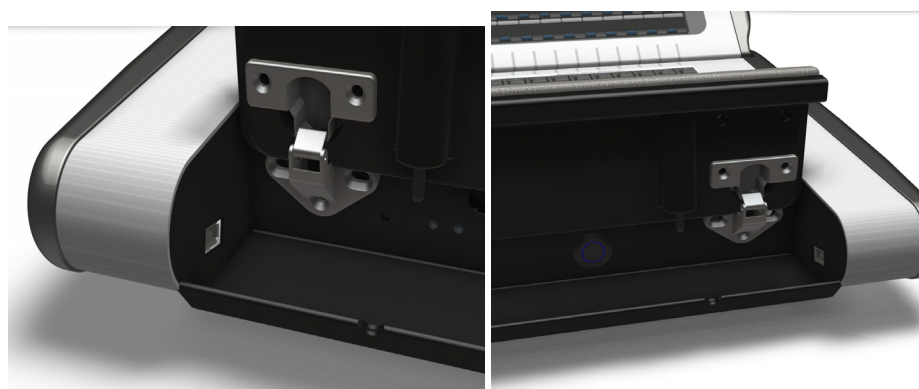

The Wrist Rest across the front of the console lifts to reveal a handy storage tray. On the left hand end is a USB socket for saving shows and power/disk indicator lights. Near the right hand side is the power switch.

The back panel

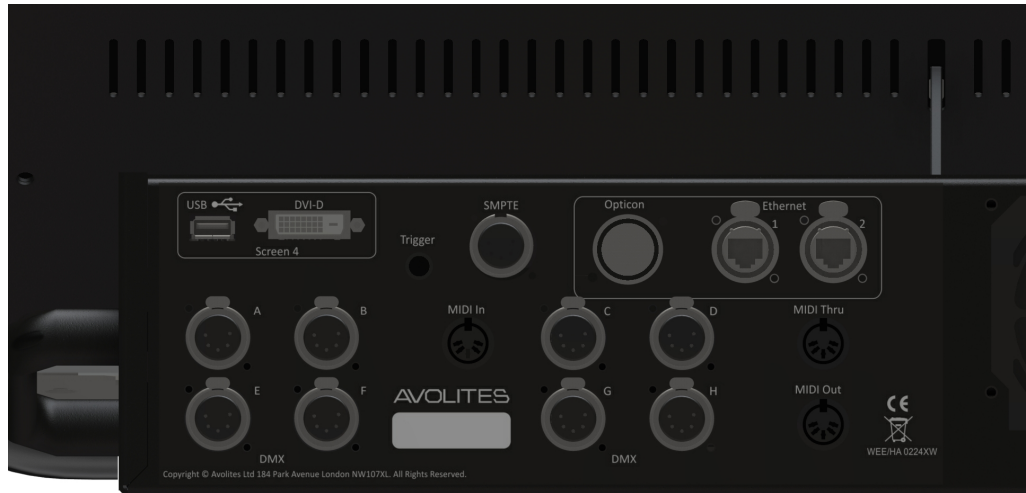

All the connections required for the console are found on the back panel.

On the left hand side are connectors for eight DMX512 outputs, MIDI, ethernet, and a DVI/USB connection for an external touch screen.

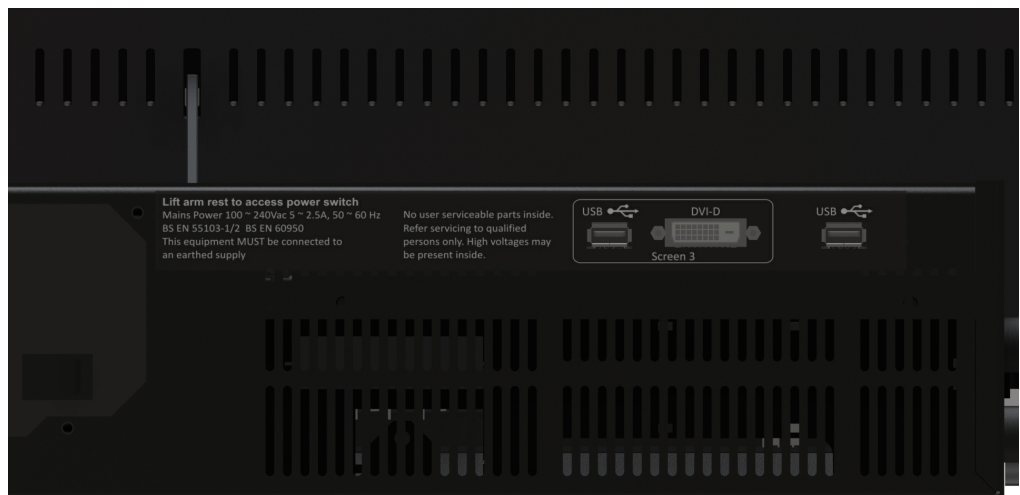

On the right hand side are DVI/USB connections for another external touch screen (screen 3) and a general purpose USB connector.

Power is connected in the middle of the rear panel

2.2 ARENA

The Arena has five main control areas:

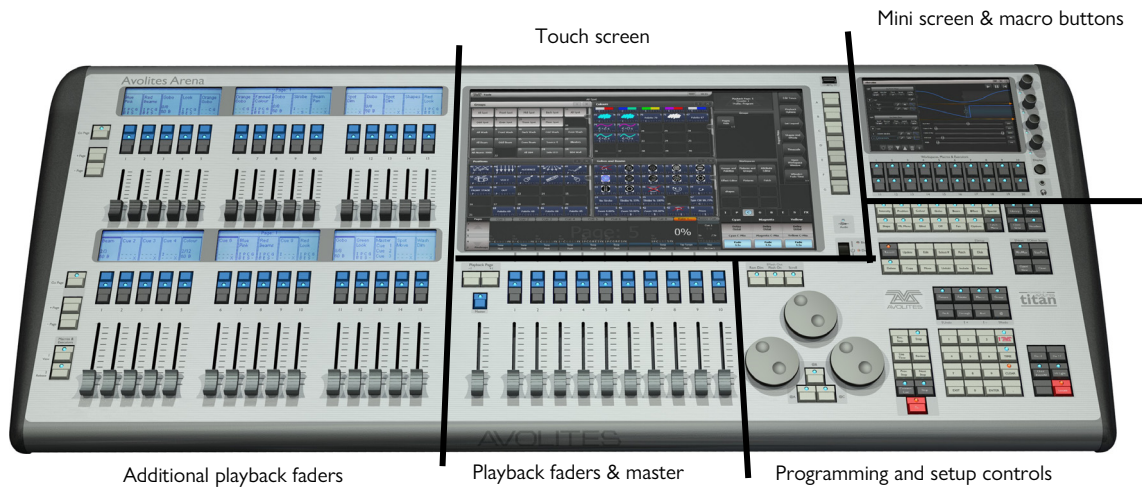

The **Touch screen** contains fixture, palette and group select buttons. It also shows legends for the playback faders and shows the current menu page and softkey buttons on the top right of the screen.

The **Playback faders** select and control cues and programs. The **additional playback faders** provide further positions for storing cues, programs, fixtures and other elements.

The **Mini screen** gives you another touch screen and additional masters or playbacks using four rotary encoders. The **macro buttons** allow storage of frequent key sequences.

The **Programming and setup controls** configure and program the console

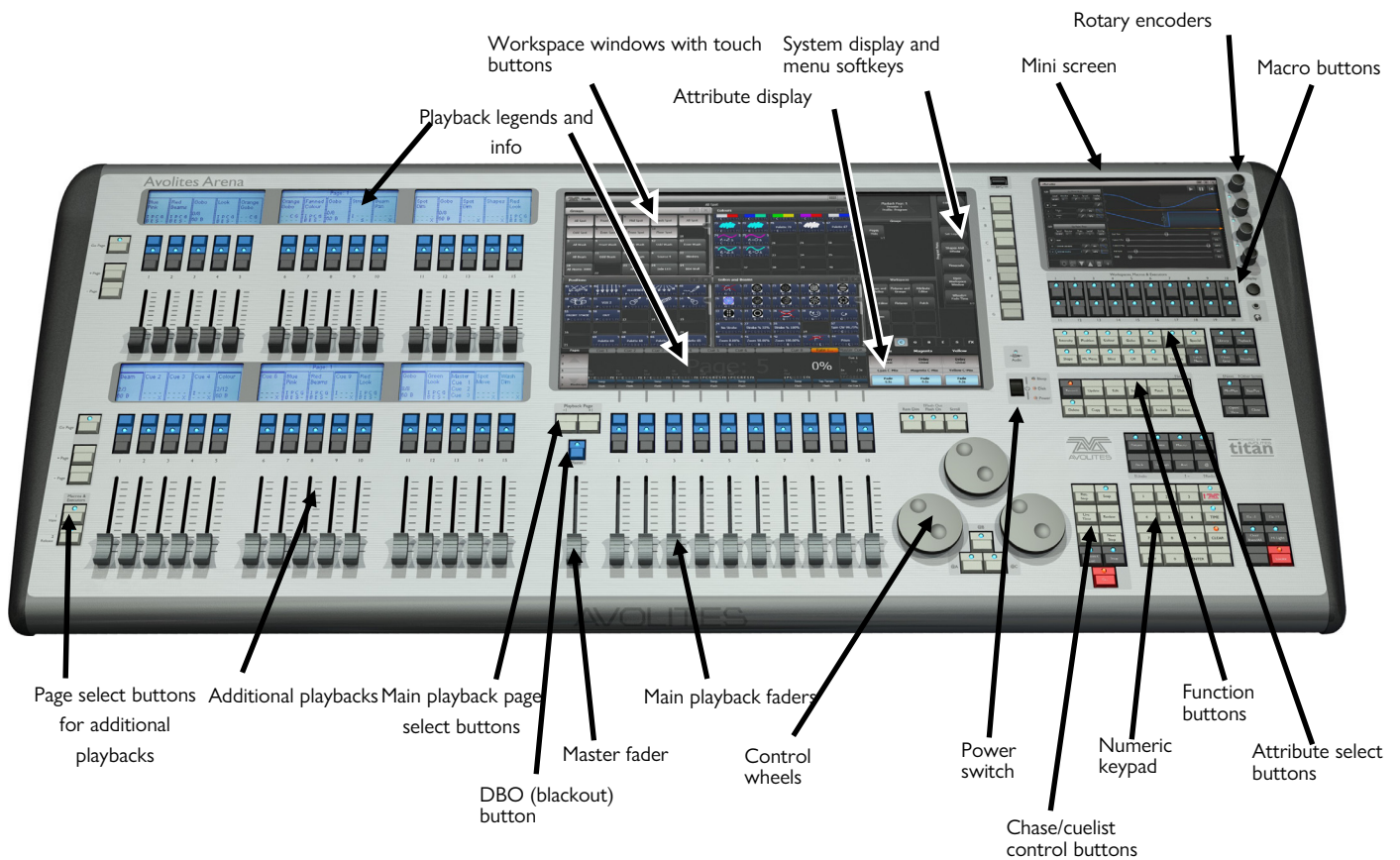

The main controls

The **Workspace windows** on the touch screen contain touch buttons for fixtures, palettes, groups, playbacks, macros and more. You can also set fixture attributes and show information windows.

The **System display and menu** area of the touch screen is the nerve centre of the console and shows you what is going on. This part of the display shows various screens of information depending on what you are currently doing.

The **Menu Softkeys** (labelled A – G) are used to select control options. The display next to the buttons shows what each one will do. The options for each key change depending on what the console is doing. Softkey commands are shown in the manual with square brackets like this: [Edit Times]

The **Mini screen** displays additional workspace windows. The four **rotary encoders** act like normal handles and can be allocated as masters or playbacks. Pressing the encoder is like pressing the blue button on a handle.

The **Macro Buttons** store frequently used sequences of keypresses which can be replayed with a single button press. Playbacks can also be stored here.

The **Master fader** controls the overall output of the console. You will normally have this set at Full. The **DBO button** allows you to blackout the whole console.

The **Playback faders** are used to store and play back cues or chases. The **Page Select buttons** let you change to a different page of playbacks. The touch screen above the faders shows information about each playback. The **Additional playback faders** in two banks of 15 allow you to store more cues and chases, or store palettes, groups, or fixtures. Each bank of 15 has separate page select buttons and displays above the faders show what they are.

The **Control wheels** are used to set control values (attributes) for the fixtures, and to set chase speeds and fades. The touch screen above the wheels shows information about the attributes being controlled. Press the **Window Scroll Button** to switch the wheels into scroll mode – this is used to move a selection box around the screen when editing.

The **Numeric keypad** and other control buttons are used to enter values and change controls on the console.

The **Function buttons** are used to carry out functions such as storing cues, copying, saving to disk, etc. These buttons have lights on to indicate when they are active.

The **Attribute select buttons** are used to select which attributes of a fixture (e.g. colour, gobo, pan, focus) are going to be controlled using the Control wheels. The buttons have lights on to show you which attributes are active. The bottom (red) button allows you to locate fixtures, which sets them to a known start position while programming.

The back panel (shown split into 3 parts)

USB and reset buttons

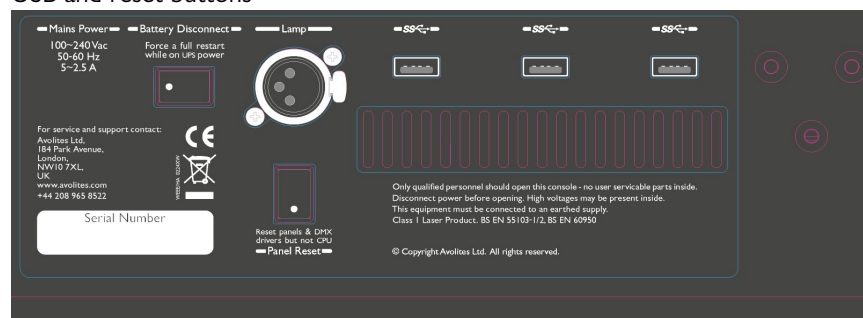

Monitor and network

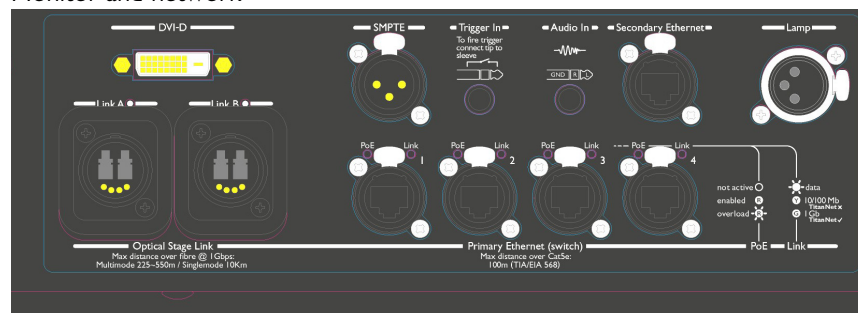

DMX and MIDI

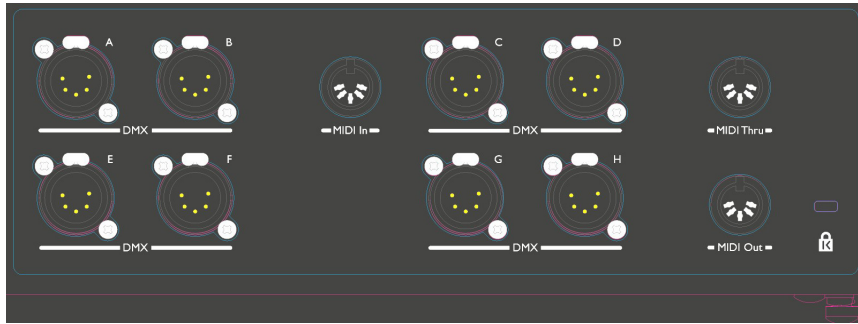

All the connections required for the console are found on the back panel. There are 8 DMX outputs on 5-pin XLR, MIDI in/out/thru on 5-pin DIN, two desk lamp sockets, four Ethernet sockets from the internal Ethernet switch, an Opticon Duo optical terminal for fibre network, a DVI connector for external monitor, three USB sockets, SMPTE input, audio input on 1/4 inch jack and remote trigger terminal on 1/4 inch jack.

The Panel reset switch may be pressed to restart the front panel electronics if something odd happens with the switches and faders. The main processor will continue running but the DMX output will be interrupted until the restart is completed.

The UPS battery disconnect switch cuts off the power to the console when it is running on UPS, in the unlikely event of a complete lock up that can't be recovered by holding down the power switch.

Using the battery disconnect switch will also power down the inbuilt network switch (TNS). Be aware of this if you are running from a backup console connected via the network switch.

The Arena console has adjustable legs to angle the console for easier operation. Lift the rear of the console and press the Leg Release button at each side to set the leg to the desired height. Make sure you support the rear of the console when adjusting the height.



2.3 TIGER TOUCH

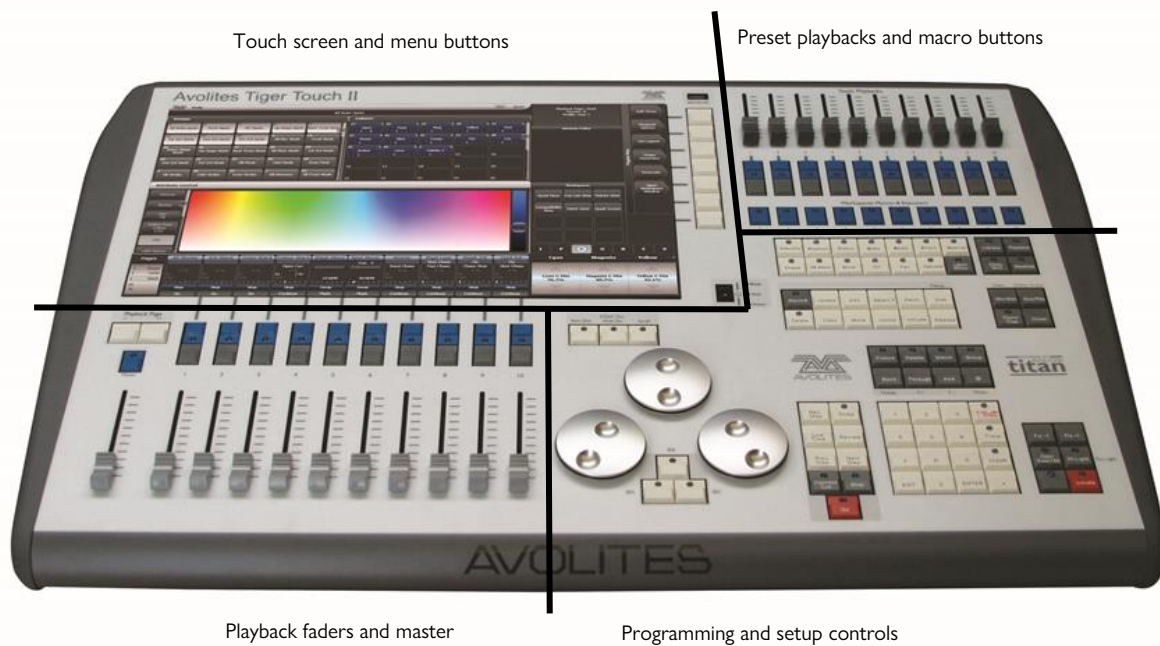

The Tiger Touch has four main control areas:

The **Touch screen** contains fixture, palette and group select buttons. It also shows legends for the playback faders and shows the current menu page and softkey buttons on the top right of the screen.

The **Playback faders** select and control cues and programs

The **Preset playbacks** give you additional (unpaged) playbacks and the **macro buttons** allow storage of frequent key sequences.

The **Programming and setup controls** configure and program the console.

(Note: The Mk.1 version of the Tiger Touch has a slightly different front panel layout)

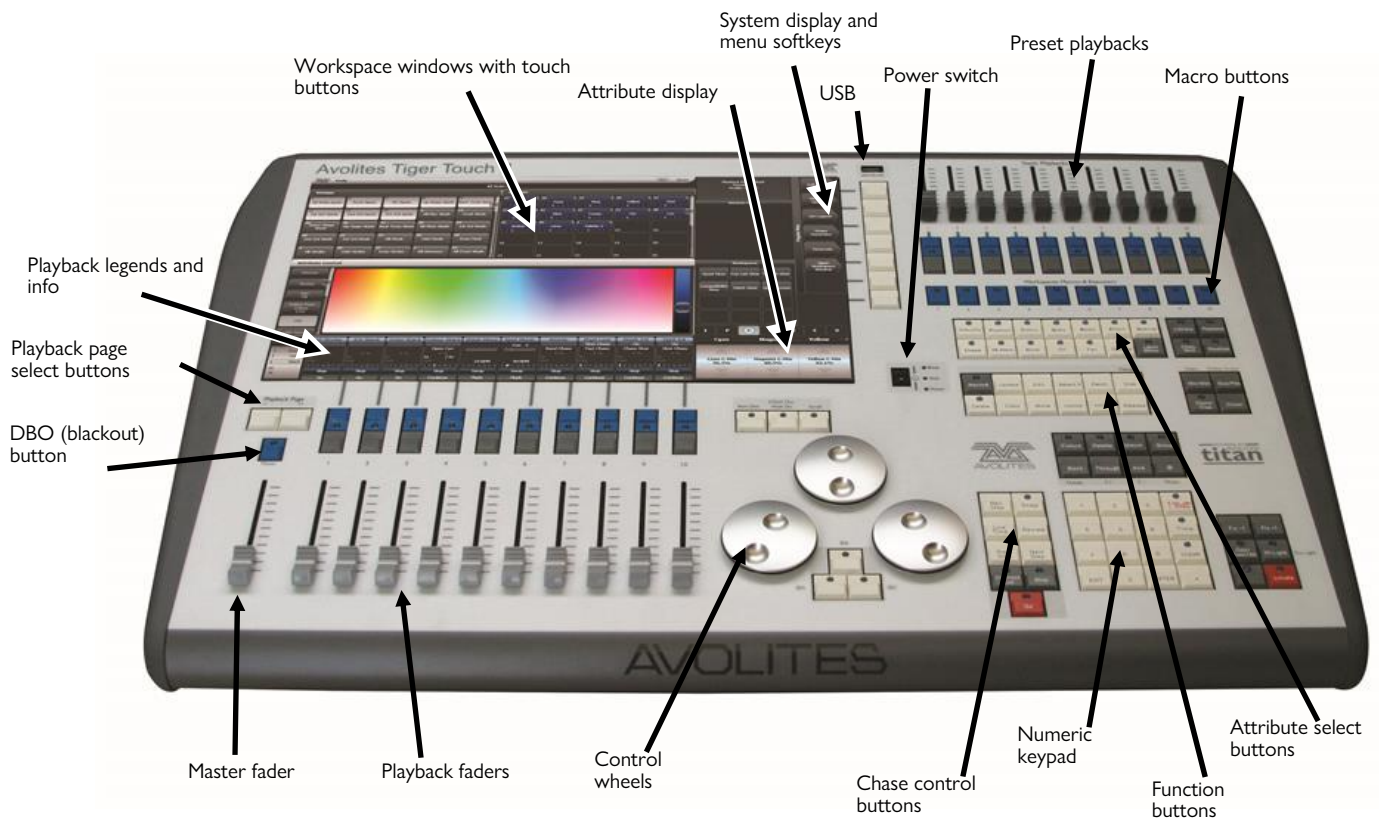

The main controls

The **Workspace windows** on the touch screen contain touch buttons for fixtures, palettes, groups, playbacks, macros and more. You can also set fixture attributes and show information windows.

The **System display and menu** area of the touch screen is the nerve centre of the console and shows you what is going on. This part of the display shows various screens of information depending on what you are currently doing.

The **Menu Softkeys** (labelled A – G) are used to select control options. The display next to the buttons shows what each one will do. The options for each key change depending on what the console is doing. Softkey commands are shown in the manual with square brackets like this: [Edit Times]

The **Preset Playbacks** are used to store and play back cues or chases that you need frequently. These playbacks are not changed by the page select buttons, but you can assign macro buttons to change pages (see section 8.1.2 on page 198).

The **Macro Buttons** store frequently used sequences of keypresses which can be replayed with a single button press. Playbacks can also be stored here.

The **Master fader** controls the overall output of the console. You will normally have this set at Full. The **DBO button** allows you to blackout the whole console.

The **Playback faders** are used to store and play back cues or chases. The **Page Select buttons** let you change to a different page of playbacks. The touch screen above the faders shows information about each playback.

The **Mode switch** selects Programming, Run or System modes of operation.

The **Control wheels** are used to set control values (attributes) for the fixtures, and to set chase speeds and fades. The touch screen above the wheels shows information about the attributes being controlled. Press the **Window Scroll Button** to switch the wheels into scroll mode – this is used to move a selection box around the screen when editing.

The **Numeric keypad** and other control buttons are used to enter values and change controls on the console.

The blue **Function buttons** are used to carry out functions such as storing cues, copying, saving to disk, etc. These buttons have lights on to indicate when they are active.

The **Attribute select buttons** are used to select which attributes of a fixture (e.g. colour, gobo, pan, focus) are going to be controlled using the Control wheels. The buttons have lights on to show you which attributes are active. The bottom (red) button allows you to locate fixtures, which sets them to a known start position while programming.

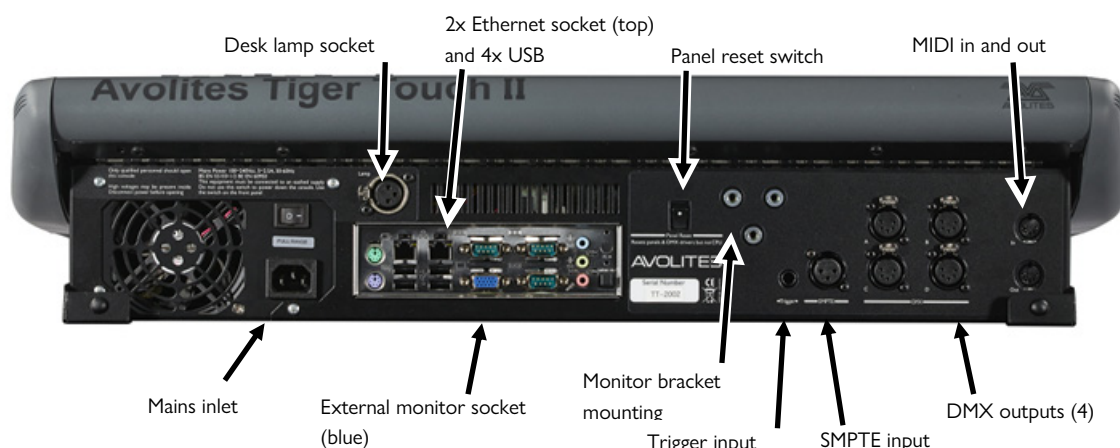

The back panel

All the connections required for the console are found on the back panel. Most are self-explanatory.

- The power switch above the mains inlet is used for isolating the power supply. Do not turn the console off using this switch.
- The Panel reset switch may be pressed to restart the front panel electronics if something odd happens with the switches and faders. The main board will continue running but the DMX output will be interrupted until the restart is completed.

2.4 QUARTZ

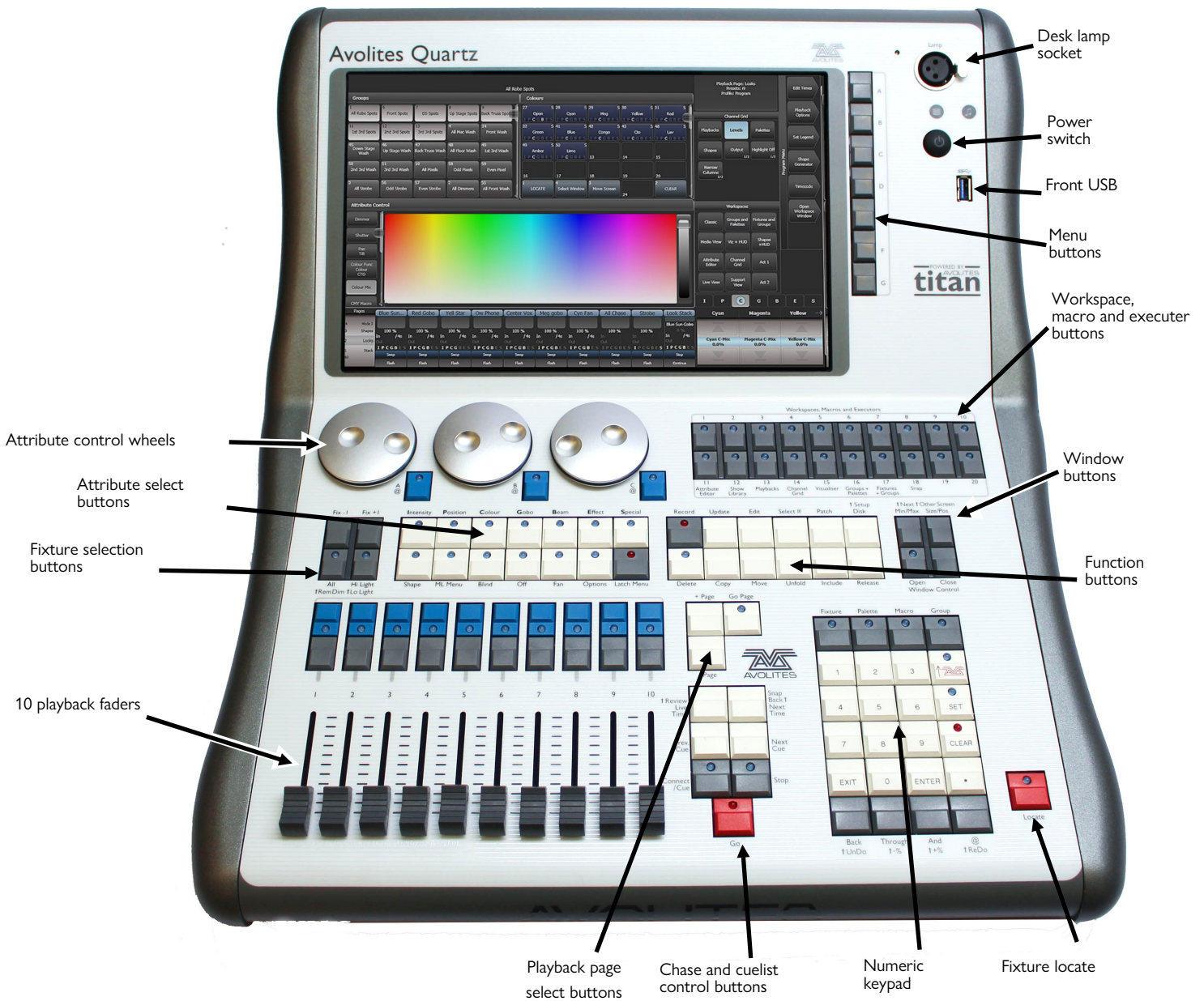

The **Workspace windows** on the touch screen contain touch buttons for fixtures, palettes, groups, playbacks, macros and more. You can also set fixture attributes and show information windows.

The **System display and menu** area of the touch screen is the nerve centre of the console and shows you what is going on. This part of the display shows various screens of information depending on what you are currently doing.

The **Menu Softkeys** (labelled A – G) are used to select control options. The display next to the buttons shows what each one will do. The options for each key change depending on what the console is doing. Softkey commands are shown in the manual with square brackets like this: [Edit Times]

The **Playback faders** are used to store and play back cues or chases. The **Page Select buttons** let you change to a different page of playbacks. The bottom of the screen shows information about each playback.

The **Attribute Control wheels** are used to set control values (attributes) for the fixtures, and to set chase speeds and fades. The bottom right corner of the screen shows information about the attributes being controlled.

The **Attribute select buttons** are used to select which attributes of a fixture (e.g. colour, gobo, position) are going to be controlled using the Control wheels. The buttons have lights on to show you which attributes are active. Attribute functions such as Fan and Shapes are also controlled here.

The **Chase and Cuelist control buttons** allow you to start and stop chases and cuelists, and move about in the list.

The **Numeric keypad** and other control buttons are used to enter values and change controls on the system.

The **Function buttons** are used to carry out functions such as storing cues, copying, saving to disk, etc.

The **Workspaces, Macros and Executers** buttons are programmable buttons which can be used to store workspaces (screen layouts), button macros or cues.

The **Workspace Window select buttons** are used to set which windows are shown on the screen.

Near the power switch there is a small hole in the front panel. This is the **Panel Reset Switch** which may be pressed using the end of a paperclip or other pointy thing to restart the front panel electronics if something odd happens with the switches and faders. The main processor will continue running but the DMX output will be interrupted until the restart is completed.

Connections panel

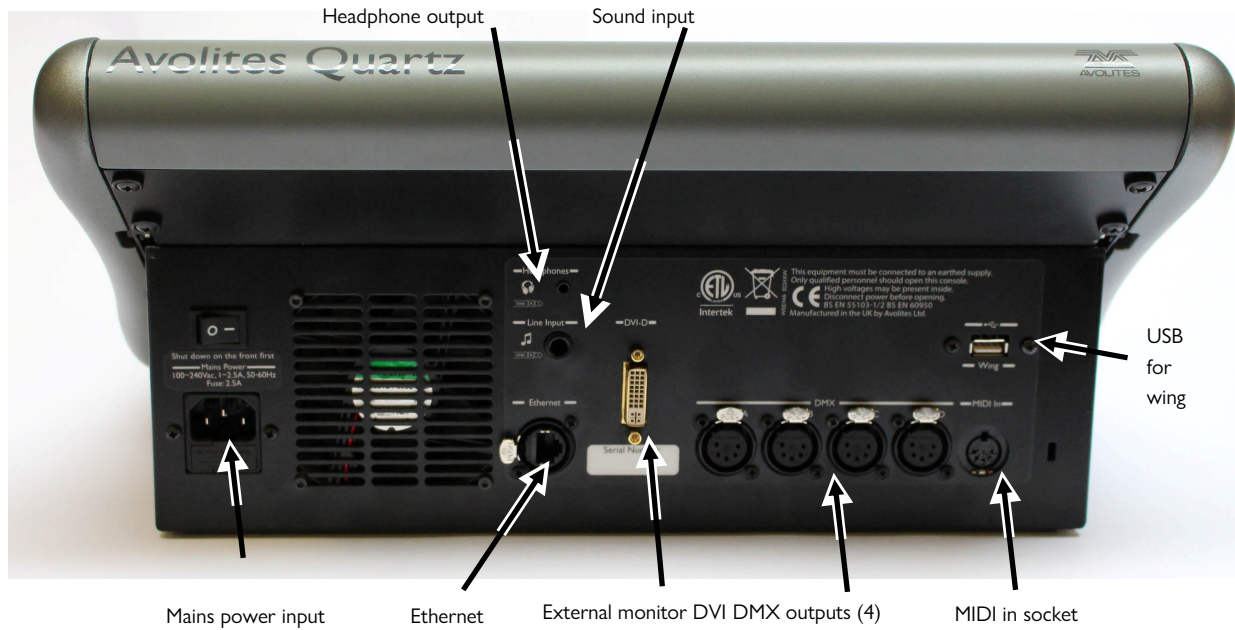

All the connections are on the rear panel. Most are self-explanatory. The power switch on the rear panel is an isolator for the power supply and should not be used to turn the console off. Use the switch on the front panel to turn the console on and off.

The rear USB connector may be used to connect a wing or an external touch screen.

2.5 TITAN MOBILE

Titan Mobile is a USB wing which plugs into a PC or laptop (Windows 7 or above, 64 bit) running the Titan software.

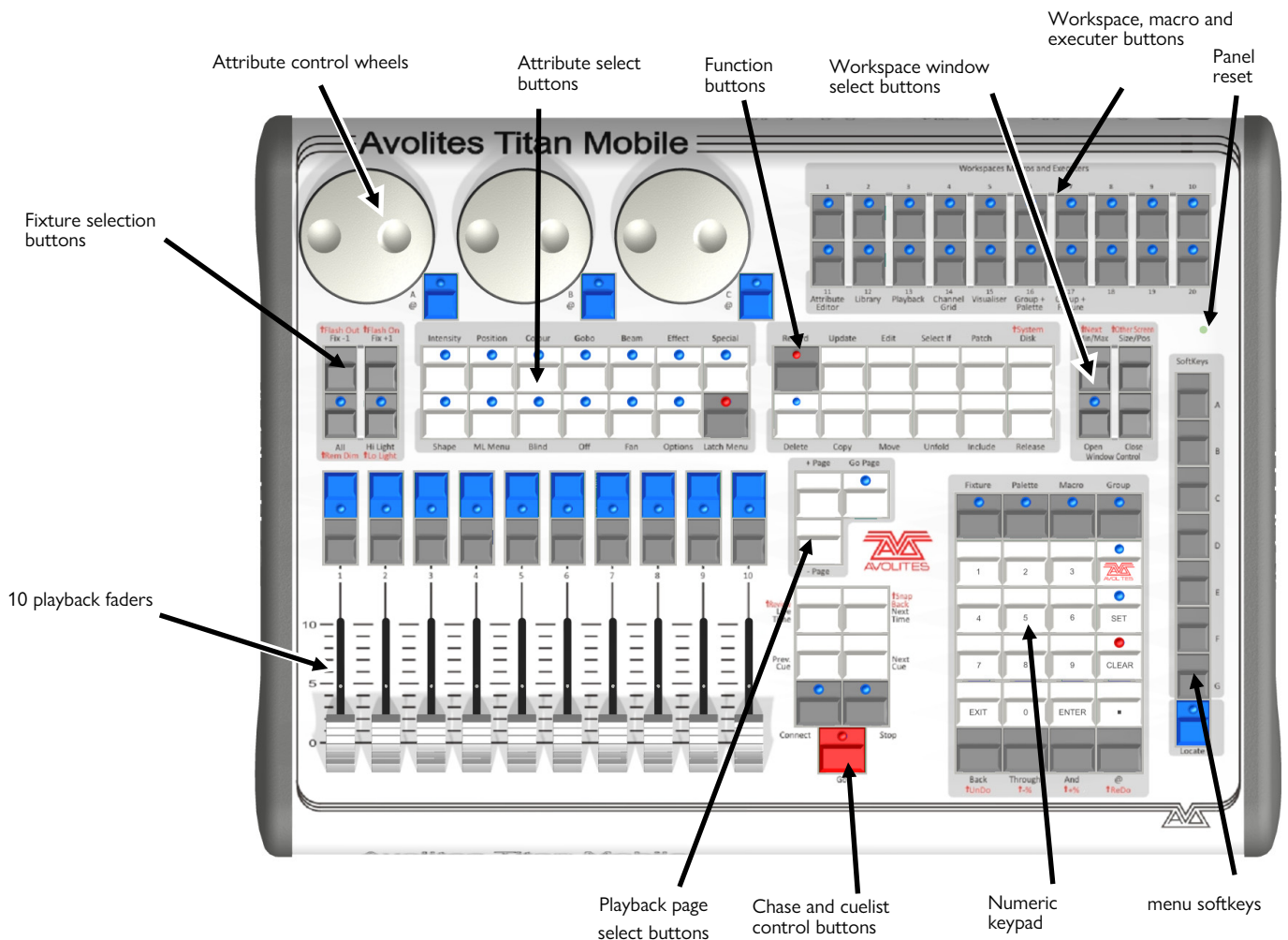

The **Playback faders** are used to store and play back cues or chases. The **Page Select buttons** let you change to a different page of playbacks. The bottom of the screen shows information about each playback.

The **Attribute Control wheels** are used to set control values (attributes) for the fixtures, and to set chase speeds and fades. The bottom right corner of the screen shows information about the attributes being controlled.

The **Attribute select buttons** are used to select which attributes of a fixture (e.g. colour, gobo, position) are going to be controlled using the Control wheels. The buttons have lights on to show you which attributes are active. Attribute functions such as Fan and Shapes are also controlled here.

The **Chase and Cuelist control buttons** allow you to start and stop chases and cuelists, and move about in the list.

The **Numeric keypad** and other control buttons are used to enter values and change controls on the system.

The **Function buttons** are used to carry out functions such as storing cues, copying, saving to disk, etc.

The **Workspaces, Macros and Executors** buttons are programmable buttons which can be used to store workspaces (screen layouts), button macros or cues.

The **Workspace Window select buttons** are used to set which windows are shown on the screen.

The screen

The system is designed to be used with a touch screen, but may be used with a mouse - just click where the manual says 'touch'.

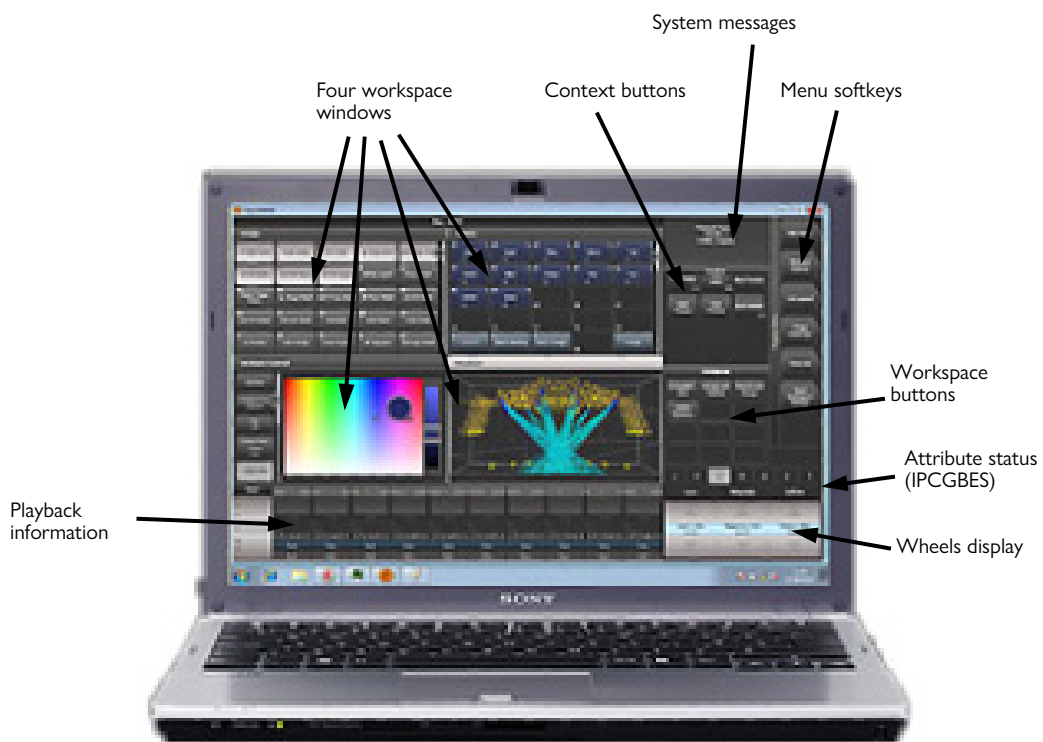

Four **Workspace Windows** may be shown on the screen. These contain touch buttons to control fixture selection, palette selection, groups, shapes, attributes, and so on. Visualiser may also be shown in a window.

The system **Menu softkeys** are down the top right hand side. You can select these by touching or clicking them, or by using the menu buttons on the right hand edge of the control panel.

System prompts are shown just to the left of the menu keys. Below that are **Context buttons** which appear when relevant to the operation you are doing.

The **Workspace Buttons** allow you to quickly select and save different workspace screen layouts.

The **Wheels display** shows the current attributes available on the 3 wheels. The **Attribute status display** above that shows which attributes are currently active or modified.

The **Playback information** shows the legend and other information about the playbacks on the 10 faders.

Titan Mobile Connections panel

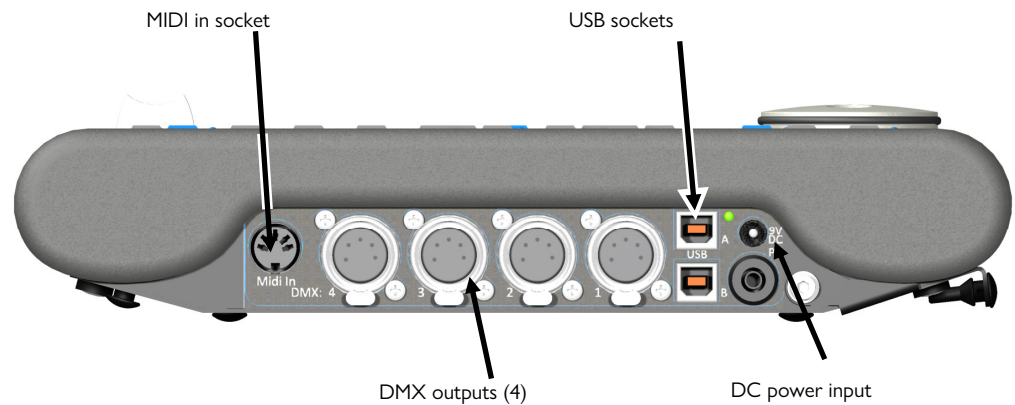

All the connections required for the control panel are found on the right hand side. Most are self-explanatory. The current version of the Titan Mobile panel has only one USB socket rather than the original 2 shown in the picture above.

- Normally the panel is powered via the USB connection. Some laptop USB ports may not provide sufficient power for the panel, in which case the DC power input can be used to connect an external 9V DC power supply, available from Avolites.
- The PE socket is to allow you to ground/earth the panel, which can help resolve DMX problems if your laptop is not earthed.

2.6 T1 AND T2

T1 and T2 are USB dongles which plug into a PC or laptop (Windows 7 or above, 64 bit). Both dongles include an AvoKey.

T1 provides a single universe of DMX output on a 5-pin XLR.



T2 provides two universes on two 5-pin XLRs and has an input for Audio/LTC timecode for external triggering. It also allows the use of a USB MIDI device for MIDI triggering of Titan, so you can use MIDI faders, and can be used with the Titan Mobile fader wing.



Install the Titan PC Suite software on your PC (see next chapter) before you plug in the dongle, to make sure the correct drivers are installed.



The older cabled version of the Titan One dongle does not include an AvoKey; a separate AvoKey must be attached to another USB port on your computer to allow use of Titan version 12 and later.

The T1 and T2 devices use a special version of the Titan software called Titan Go. The operating screen is slightly different to the normal display as it is designed for use on a touchscreen with no physical control surface (actual faders or buttons).



2.7 TNP (TITAN NET PROCESSOR)

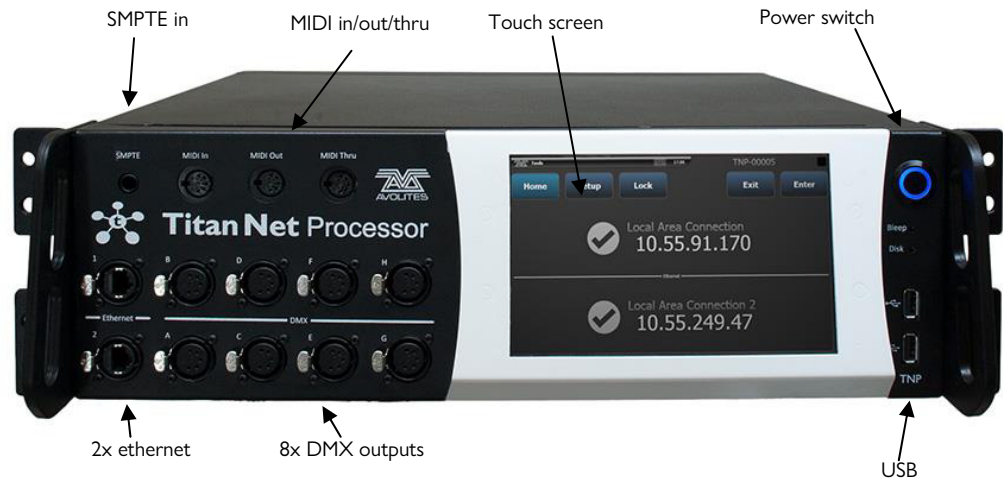

The TitanNet Processor is the insides of a console without the control surface. It allows you to expand the number of DMX lines in a show beyond the 16 which a console can produce by offloading the processing into a separate unit.

It is also possible to improve robustness by running the whole show from one or more TNP units onstage and having the console simply acting as a remote control. The TNP can also act as a simple stand-alone controller using the onboard touchscreen, or by connecting an external touchscreen you can operate it using the Titan Go screen. It can load shows which have been created on a full console. You can also use a console in multi-user mode to create shows directly on the TNP.

Section 15 covers the operation of TNP.

2.8 PEARL EXPERT AND TOUCH WING

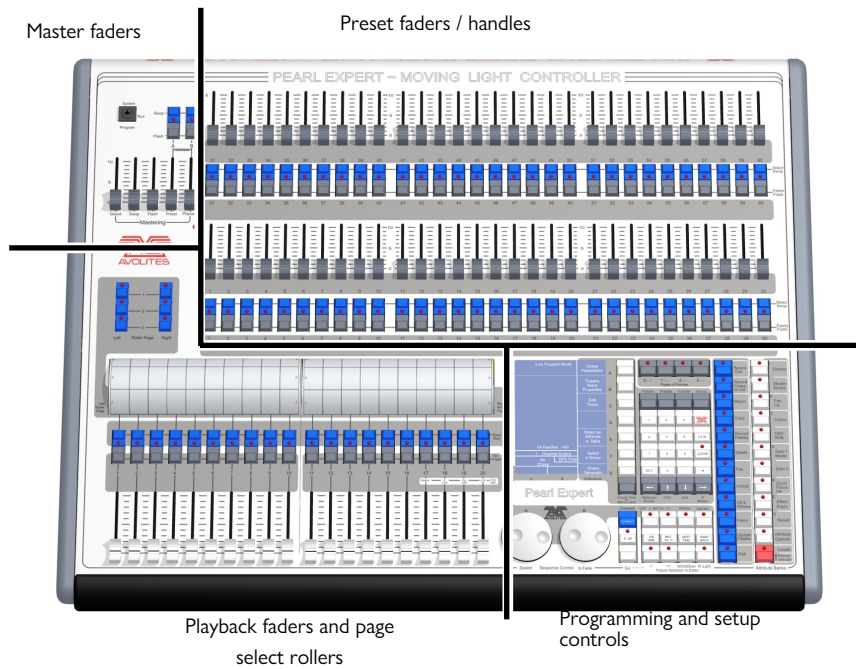

The Pearl Expert has four main control areas:

The **Master faders** set overall levels on the console

The **Preset faders/handles** select and control individual fixtures (and you can store cues and chases here too)

The **Playback faders** and **rollers** select and control cues and programs

The **Programming and setup controls** configure and program the console

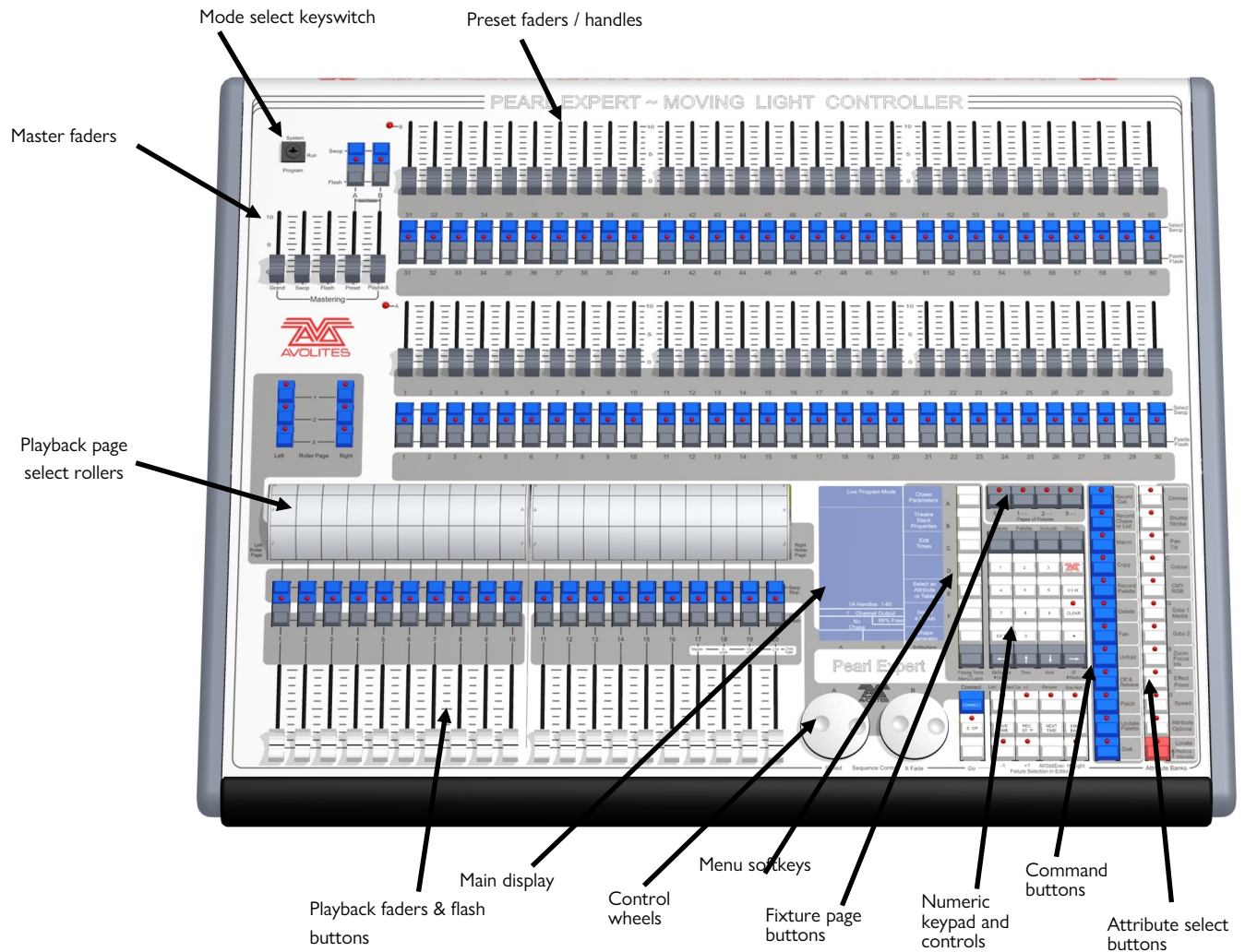

The main controls

The **Preset Faders** are used to control individual dimmer channels and fixture intensities. Cues and chases can also be stored on these faders. The 2 buttons below the faders are used to select and flash whatever is stored on the fader. Each fader and buttons is called a 'Handle'.

The **Mode select keyswitch** selects Programming, Run or System modes of operation.

The **Page select rollers** let you select different pages of playbacks, and you can write the playback names on the rollers so you know what's in them. There are 2 rollers each controlling 10 playback faders

The **Master faders** control the overall output of the various parts of the console. You will normally have these set at Full.

The **Playback faders** and flash buttons are used to play back cues or chases you have programmed, when you are running a show.

The **Main display** is the nerve centre of the console and shows you what is going on. The display can show various screens of information.

The **Control wheels** are used to set control values on the fixtures, and to set chase speeds and fades.

The **Menu softkeys** (labelled A – G) are used to select control options. The display next to the buttons shows what each one will do. The options for each key change depending on what the console is doing. Softkey commands are shown in the manual with square brackets like this: A [Edit Times]

The **Numeric keypad** and other control buttons are used to enter values and change controls on the console.

The **Fixture Page** buttons are above the keypad, and allow selection of 4 pages for the Preset Faders.

The blue **Command buttons** are used to carry out functions such as storing cues, copying, saving to disk, etc. These buttons have lights on to indicate when they are active.

The **Attribute select buttons** are used to select which attributes of a fixture (e.g. colour, gobo, pan, focus) are going to be controlled using the Control wheels. The buttons have lights on to show you which attributes are active. The bottom (red) button allows you to locate fixtures, which sets them to a known start position while programming.

A **QWERTY keyboard** and mouse touchpad is provided in a drawer on the front of the console.

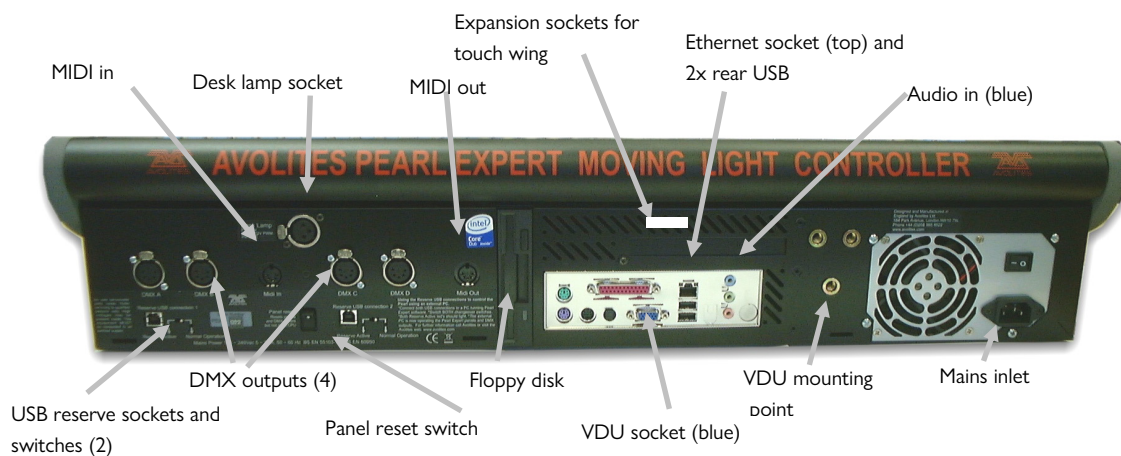

The back panel

All the connections required for the console are found on the back panel. Most are self-explanatory.

- The Panel reset switch may be pressed to restart the front panel electronics if something odd happens with the switches and faders. The main board will continue running but the DMX output will be interrupted until the restart is completed.
- The USB reserve sockets and switches are for future expansion. The switches should be set to 'Normal operation'.

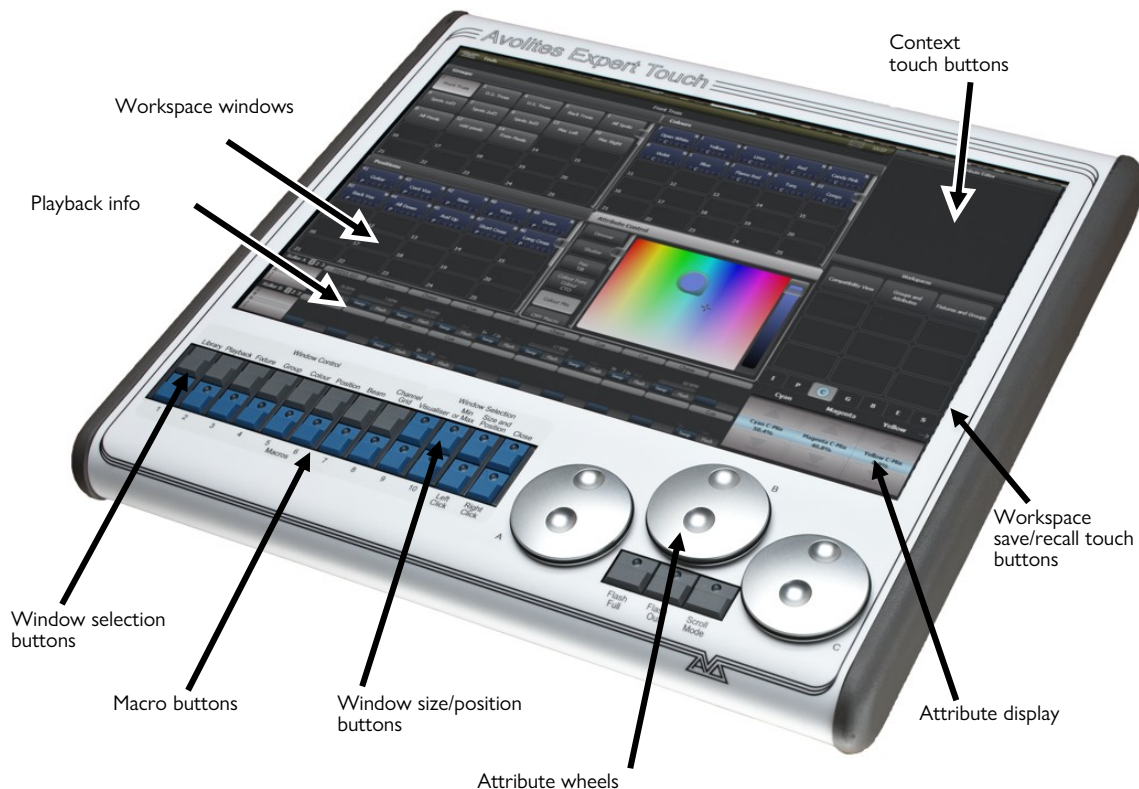

The Pearl Expert Touch Wing

The optional Pearl Expert Touch Wing uses a touch screen and additional wheels to provide the standard Titan interface for selecting fixtures, palettes, groups and setting attributes. It can only be used with the Pearl Expert and connects to the DVI port and the 9-pin D connector on the rear of the console, just above the panel with the rear USB/network sockets.

The main area of the Touch Wing shows up to 4 **workspace windows**. You can select the content and configure the size and layout of these windows using the Window Selection and Size/Position buttons below the screen.

The arrangement of windows can be saved and recalled using the **Workspaces** touch buttons on the right of the screen.

Some windows have additional command buttons which are displayed in the **Context touch buttons** area on the top right of the screen when the window is active.

The three **Attribute Wheels** take over attribute control from the wheels on the console, which are then used for speed/fade control of chases. Below the wheels the **Scroll Mode Button** to switch the wheels into scroll mode – this is used to move a selection box around the screen when editing.

The **Attribute Display** shows which attributes are being controlled by the wheels, and the current settings. Touching the roller graphic will set the attributes to min or max.

Across the bottom of the screen there is an area showing information about the **playbacks** on the current roller pages.

2.9 FADER WINGS

“Wings” are additional control surfaces which can be connected to the console to provide more faders and buttons, and in some cases extra touch screens.

TIGER TOUCH WING

The Tiger Touch wing provides 30 additional handles each with an associated legend display. The handles can be used as playbacks or to patch fixtures/dimmers. Each row of 15 faders has its own independent paging control.



The Tiger Touch Wing connects by USB to the main console. It also needs a mains power connection. The Wing has a built in USB hub to provide 2 further USB sockets for a keyboard etc.

The Tiger Touch Wing is designed to fit next to the Tiger Touch console but can also be used with the Pearl Expert, the Arena and the Sapphire Touch.

TITAN MOBILE WING

The Titan Mobile Wing adds 20 additional playback faders and 30 macro/executor buttons to the main console. It connects by a single USB cable to the console or the PC running the Titan software.

It is designed to fit next to the Titan Mobile panel, but it can also be used with the Tiger Touch, Quartz, Arena and Sapphire Touch consoles, and the Titan Two dongle.

If you want to see the legends and function information for the wing controls, you can open the Wing View workspace window on the main console.



3. CONNECTING UP AND TITAN BASICS

This section covers how to connect the console up, and the basic things you need to know about operating Titan.

3.1 CONNECTING UP

3.1.1 CAUTIONS



Radio transmitters may affect the operation of the console and we recommend that they are not placed on, above or behind the console. If you are wearing one it is best placed in a back pocket or behind you when attached to a belt.

3.1.2 CONNECTING MAINS POWER

You can safely connect the console to any voltage from 80 to 260V. If your console is not fitted with an internal UPS (uninterruptible power supply) we recommend that you should power the console via an external UPS (available from computer suppliers). If a UPS is not used, when the sound engineer pulls out the wrong plug and kills power to the console you can lose data (up to the last Autosave) and the console may want to check its disk on startup which can cause delays. The UPS will protect you from most power problems and give you chance to shut down the console normally.

If an internal UPS is fitted (Sapphire Touch, Arena, optional on other consoles), on power loss the toolbar on the screen will turn orange and display how long you've got before the console shuts down.



When the UPS battery runs low and the console is about to shut down, the toolbar turns red.

Arena only: The Network Switch inside the Arena has an independent UPS system which allows the network switch to continue to run while the console is power cycled. When the console is shut down the network switch will continue to run for about 5 minutes. This is important when a backup console is running the show through the network switch in the Arena, as it allows the Arena to be power cycled without losing the network link to the stage.

3.1.3 STARTING UP AND SHUTTING DOWN

The console runs a Windows-based operating system internally, so you need to make sure it is shut down properly rather than just turning off its power.

Start up the console by pressing and releasing the Power switch on the face or front edge of the console (lift up the wrist rest on the Sapphire Touch). The console display(s) should come alive. The console takes up to 1 min 30 seconds to start up.

Shut down the console by pressing and releasing the Power switch again. The console will perform a controlled shutdown. Wait until the Power light has gone off (about 30 seconds) before you disconnect power from the console.



If the console has a switch on the power module on the back, do not use this to turn off the console as this does not close down the software properly and you will lose any changes to your show.

3.1.4 FORCED SHUTDOWN

To carry out a **Forced Shutdown** of the console, if the normal shut down does not work, hold down the power switch for 5 seconds. You will lose any changes to your show since the last save.

On consoles with a built-in UPS, you cannot just pull out the power to shut down the console if it is not possible to shutdown the console by any of the above means. In this case having disconnected the mains power you should press the Battery Disconnect switch on the rear panel.

Arena only: Battery Disconnect will also shut down the internal network switch so be careful if you are running a backup console via the switch. When you shut down the Arena normally, the network switch will stay on for about 5 minutes then power off. There is no harm in leaving it to do this.

3.1.5 CONNECTING UP TITAN MOBILE AND T1/T2

Do not connect the Titan Mobile panel or the T1/T2 dongle to your PC for the first time until you have installed the Titan PC Suite software, which you do simply by running the installer file. This will make sure the drivers for the panel are installed.



From Titan v7, Windows XP and Vista are no longer supported. Your PC must be running a 64 bit version of Windows 7, Windows 8.1 or Windows 10.

For best usability, your PC should have a touch screen. If not you can use the mouse to select touch buttons.

Titan Mobile: Having installed the software, connect the USB cable for the panel (older Titan Mobile panels have two USB connectors – you only need to connect port A, nearest the DC socket). If your PC asks you for drivers, select 'Install the Software Automatically'. If you have an older Titan Mobile panel without the built-in AvoKey you also need to attach an AvoKey to a free USB port.

Power is normally supplied down the USB connection and the external DC power socket is not used, but if your PC has a lot of other USB devices plugged in, or in the case of some laptops, an external DC power supply may be needed. The required power supply is: 9-12 volt 800mA DC. Connector: 2.5mm hole, outside diameter 5.5mm, length 9.5mm, wired centre pin positive. Example Part number: DCP2

The first time you run Titan Mobile you will need to obtain a licence from the Avolites website. The licence is keyed to the internal AvoKey in the Titan Mobile panel so you

can install the software on multiple computers but it will only run when the Titan Mobile panel is connected. See section 16.8.2 on page 340 for more details.

T1/T2: The T1/T2 USB devices give you a full lighting control system that will output one or two universes of DMX or Artnet. The software to run it is called Titan Go. The first time you run Titan Go you will need to obtain a licence from the Avolites website which will license the AvoKey built into the device. See section 16.8.2 on page 340 for more details.

3.1.6 TITAN HEALTHCHECK

When the Titan software starts up, it runs a small utility called Titan Healthcheck which checks the file system and the installed firmware and software for anything that might cause you problems. If any problems are found, a warning screen is displayed which offers the option to fix the problems.



Only run fixes if you have plenty of time as some fixes can take up to an hour to complete.

3.1.7 CONNECTING DMX LINES

The console communicates with lighting fixtures using the DMX512 system. The console itself can output 16 universes of DMX (each 512 control channels). If you need to output more universes, it is recommended to network the console to one or more Avolites TitanNet processing nodes. This off-loads the DMX processing, allowing the console to control up to 64 universes of DMX in total (see section 16.5.1 on page 330 for more details).

The console has DMX outputs on 5-pin XLR for direct connection to fixtures and dimmers, and can send DMX over Ethernet and wireless Ethernet systems to allow connection to remote DMX Ethernet nodes, media servers, and so on.

When you patch a dimmer or fixture you tell Titan which of the DMX universes it is on. Each universe can be configured to come out of one or more of the standard DMX outputs on the back of the console, and/or over an Ethernet protocol (see section 18 on page 345.)

The Arena includes a built-in Ethernet switch and has an optical network connection. See section 18 on page 345 for details of how to network the Arena console.



By default on a new show, the XLRs on the console are automatically connected to DMX lines starting at line 1, however if you are loading a show from a different model of console or the simulator, check the DMX Settings option to confirm how the DMX outputs are set up.

The 5-pin XLR sockets on the console are wired like this:

Pin 1	Earth
Pin 2	Data -
Pin 3	Data +
Pin 4	Not used
Pin 5	Not used

Each DMX line should pass through all the fixtures to be connected on that line one after the other and have a DMX terminator fitted at the end (120 ohm resistor between pins 2 and 3). You should not split the DMX lines using passive splitters (Y-splitters) as this can corrupt the data.

3.1.8 CONNECTING A MONITOR

You can connect an additional monitor to the console (2 monitors on Sapphire Touch). This gives you extra screen space for workspace windows which can be handy for showing Visualiser or additional buttons. Touch monitors are very useful to give additional control surfaces. We advise you use a monitor compatible with Windows Touch to avoid problems with touchscreen drivers. Titan Mobile will also support 2 monitors if the PC you are using has the facility.

An external monitor is disabled by default and will show a 'disabled' message. To enable, switch to System mode (press <Avo>+<Disk>) and select [Display Setup] then press [External Display Disconnected]. The option will change to [External Display Connected] and the display will be enabled.

If you need to change the monitor resolution or settings, touch 'Tools' at the very top of the screen and select 'Control Panel', then 'External Monitor', then select the option to match the resolution of your monitor.

There are more details about setting up an external monitor, including troubleshooting help, in section 16.2 on page 321.

3.1.9 OTHER CONNECTIONS

You can connect a USB keyboard and mouse to the console. If you are using an external non-touch monitor on a console without a built-in keyboard/touchpad you will need a mouse to access the buttons on it, or on the Sapphire Touch you can use the trackball in mouse mode.

You may need to use a small USB hub to connect additional devices if the console does not have enough USB sockets itself.

All consoles provide MIDI connections which can be used to trigger playbacks or connect MIDI timecode to the console for timecode-controlled cue lists. Except for Pearl Expert, a SMPTE input is provided on the rear panel to allow the console to be linked to a timecode source. MIDI cannot be used with the T1 dongle, but can be used with T2 if you attach a USB-MIDI device.

You can connect the console to a LAN (local area network) using the RJ45 network socket on the rear. This allows you to operate many more universes of DMX using DMX network protocols, and also allows backup and multi-user consoles to be connected to each other. The Arena has several network ports and also has one or two optical fibre terminals allowing direct fibre connection to the control network.

One or two 3-pin XLR sockets for desk lamps are provided on the rear of the console. Suitable lamps are available from Avolites. The lamps are 12 volt DC, wired from pins 1 (negative) and 2 (positive) of the XLR (not all desk lamps are wired like this and may require rewiring to work). You can set the brightness of the desk lamps from System mode.

3.1.10 CONNECTING CONSOLE WINGS

“Wings” are additional control surfaces which can be connected to the console to provide more faders and buttons. They connect to the console by USB. See section 2.9 on page 48 for more details of the available wings.

The Pearl Expert Touch Wing can only be used with the Pearl Expert console and should be connected before the console is powered up.

3.2 WORKSPACE WINDOWS

The main area of the screen contains the workspace windows. These contain buttons for selecting fixtures, groups, palettes, playbacks and so on. Information windows such as Playback View and the integrated Visualiser application can also appear as a workspace window.

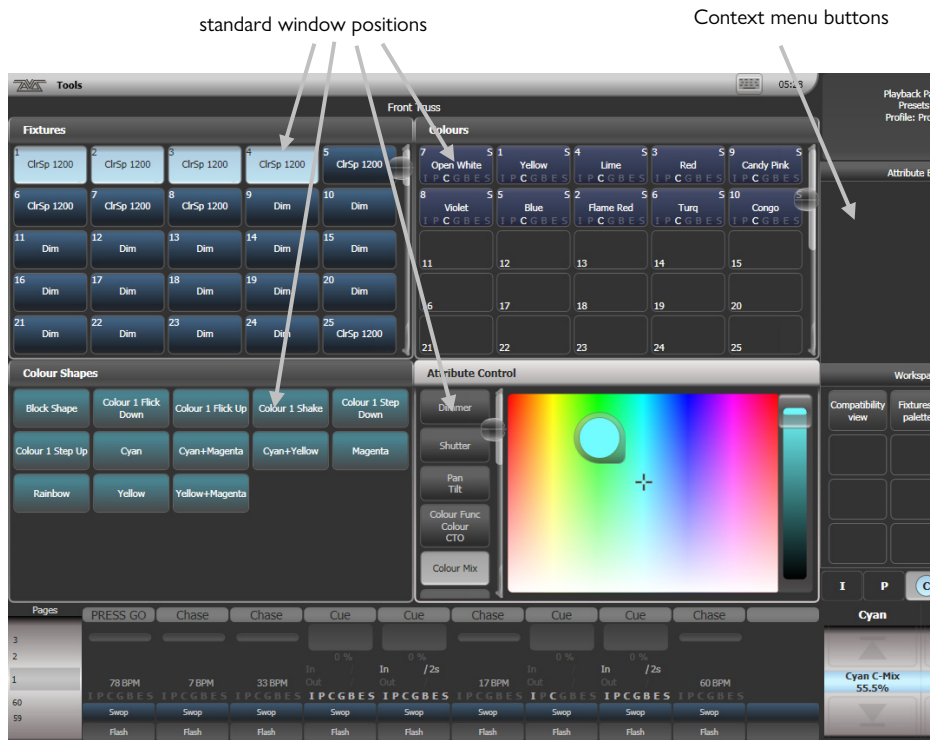

Sapphire Touch displays are slightly different:

Sapphire Touch Left touch screen

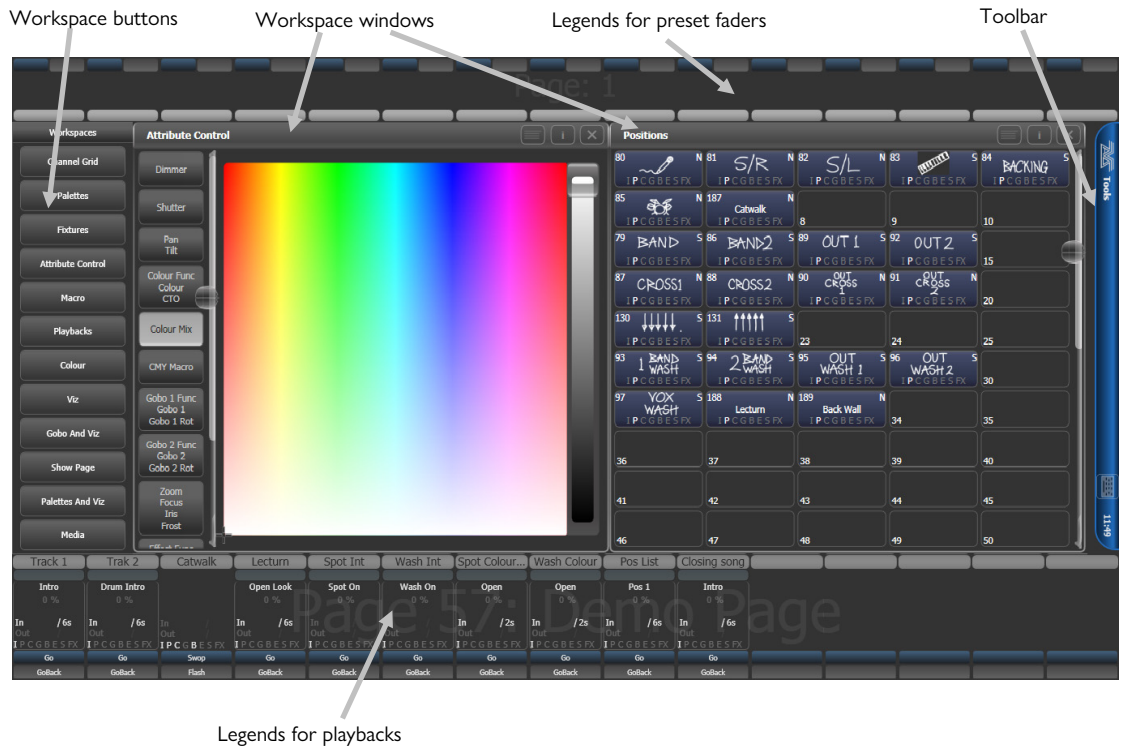

Sapphire Touch Right touch screen

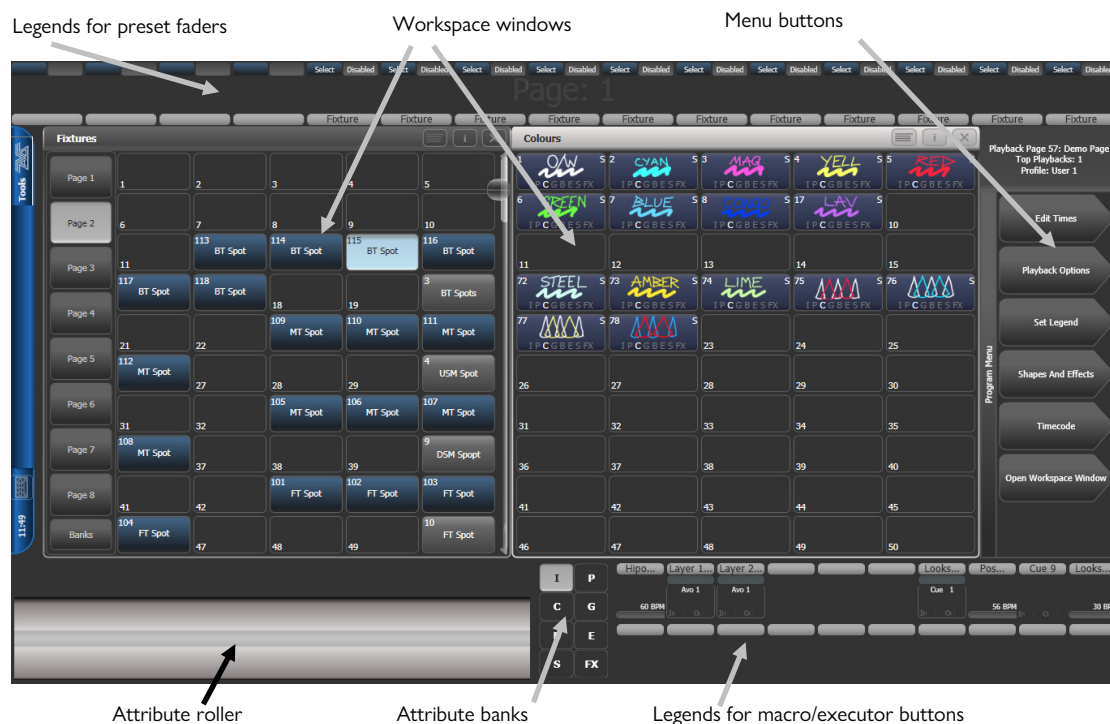

3.2.1 OPENING AND POSITIONING WORKSPACE WINDOWS

You select which workspace windows you want to see using the [Open Workspace Window] menu command on the root menu. You can also press the <View> button (labelled <Open> or <Open Window> on some consoles) to access the [Open Workspace Window] option while in another menu and there are shortcuts to open some windows as listed in the next section. In the rest of this manual we'll refer to this button as <View/Open> to cover both options.

You can change the positions and sizes of the windows by using the Window Control buttons near the numeric keypad or the Window Options button (cog icon) at the top of each screen, more details are given in the next section. The min/max button swaps the active window between full screen and quarter size. The size/position button moves the active window around the possible positions. You make a window active by clicking/touching its header bar.

You can move the active window to a different monitor by pressing <Avo> and the Size/Position button, or <View/Open> then [Window Options] then [Move Screen].

SHORTCUTS TO OPEN WORKSPACE WINDOWS

Press <View/Open> then an Attribute Bank button to open the Palette window for that attribute.

Press <View/Open> then <Patch> to open the Patch View window.

Press <View/Open> then a fixture select button to open the Fixture View window showing patch details for that fixture.

Press <View/Open> then <Connect> to open the View Cue window.

Press <View/Open> then <Off> to open the Active Playbacks window.

Press <View/Open> then <Macro> to open the Macro window.

WINDOW SETUP BUTTONS

At the top right of each workspace window are three or four buttons which access other functions for the window.

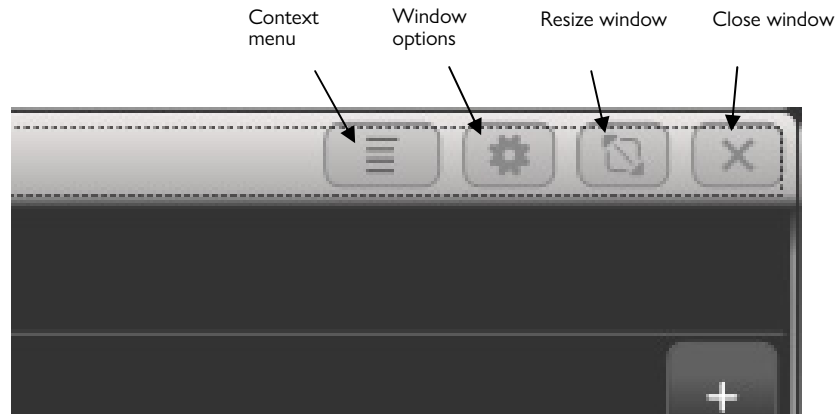

The **Context Menu** button is only shown on Sapphire Touch and Titan Go, and gives a drop down menu at the top of the window showing the context menu buttons which relate to the current window.

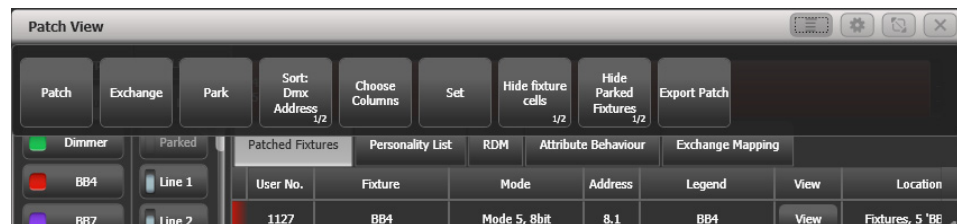

On all other consoles the context menu buttons are automatically shown below the prompt area on the top right of the main screen. These buttons change to match the active window. The picture below gives an example of how the context buttons appear when Patch View window is active.



The **Window Appearance Options** button (cog icon) lets you select the standard window sizes and positions. Buttons are also shown allowing you to set the button size and the text size of the window, and move the window to an external monitor. The Appearance options may vary depending on which window it is, the setup of the console and if you have any external monitors.

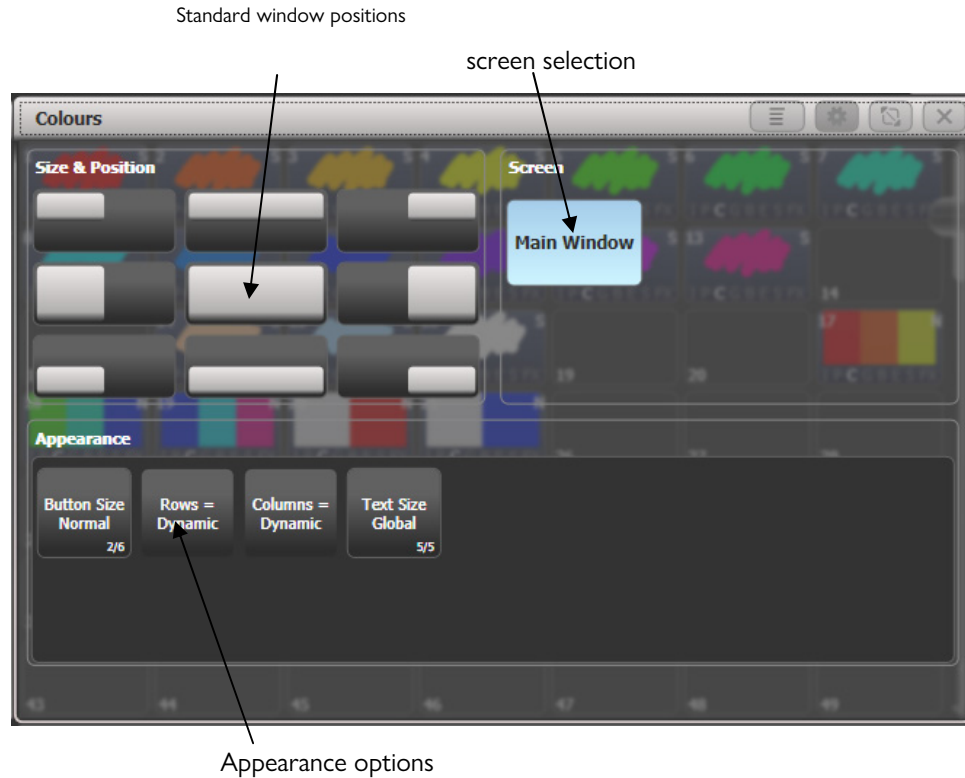

The **Resize Window** button allows you to set adjustable window sizes. A grid screen will open.

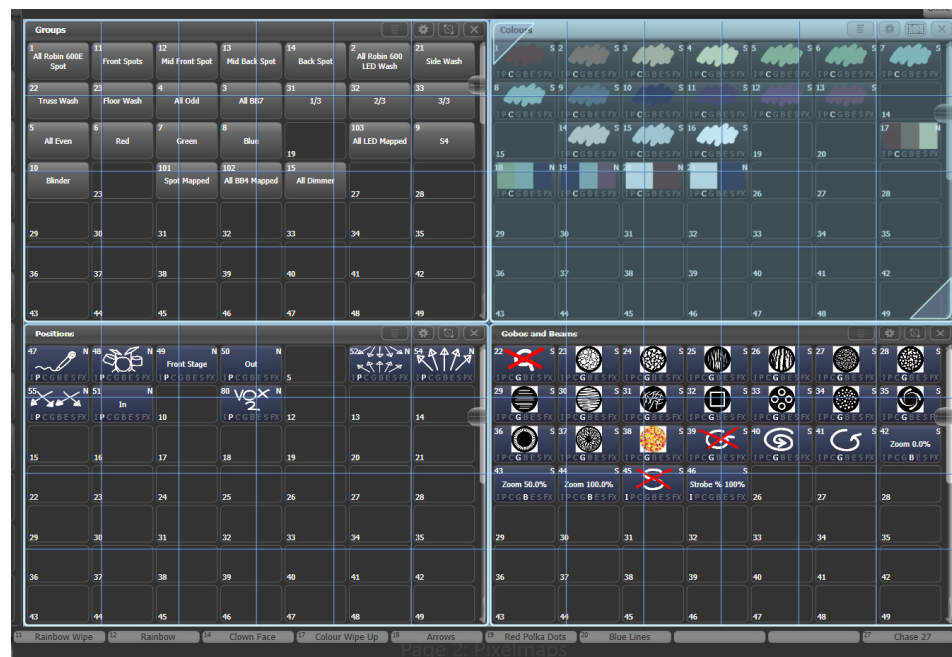

With the softkey [Edit All Windows] set to Off, you just set the size of the selected window.

Touch and drag the top left or bottom right corners to resize the window. Touch and drag anywhere else to move the window.

Tap on a corner to set a start corner position – the window will highlight in red and ask you to tap to set the opposite corner position.

If the softkey [Resize Neighbours] is set to On, surrounding windows will resize to make room for the window you are editing. If Off, the other windows will stay the same size and go behind the current window.

If [Edit All Windows] is set to On, corner arrows will appear in all windows and you can adjust the size of all the windows together. Press <Enter>, <Exit> or [OK] to finish.

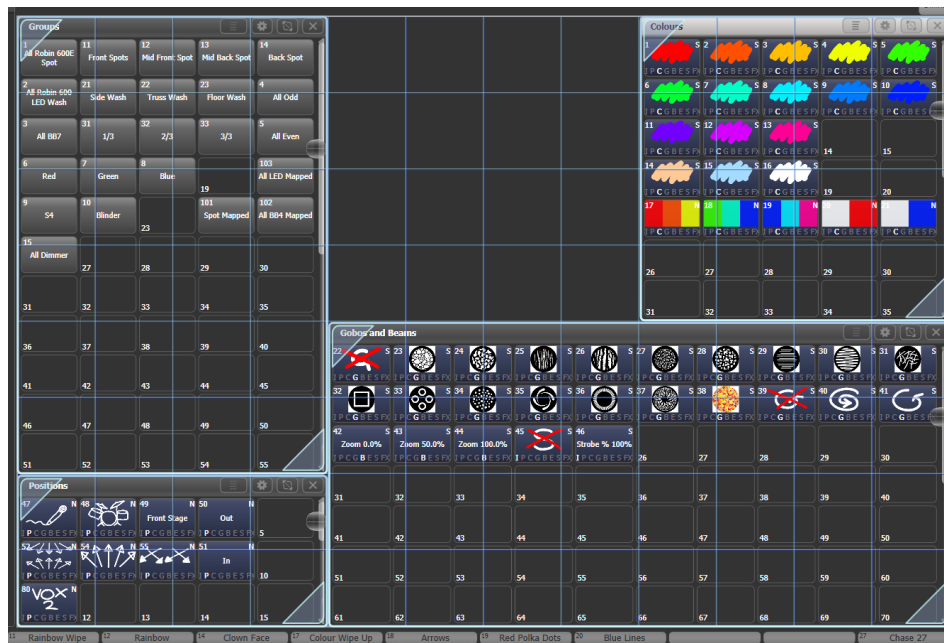

If you accidentally set a window to a single grid size, you can't then get to the Window Layout button to resize it. Select the window and use the [Min/Max] softkey to set the window to a fixed size.

You can move the active window between screens from the Window Appearance screen, or by pressing View then [Window Options] then [Move Screen], or hold <Avo> and the <Size & Position> button.

You can close the active window using the <Close> button (not on all consoles). You can close all windows by pressing <Avo>+<Close>, or use the [Close All] softkey.

CONTROLLING BUTTON LAYOUT / GRID

Buttons normally resize automatically to suit the screen size and resolution, however this means that moving shows between different consoles or different screens can make the number of rows and columns change, causing buttons to move around. If you have set a particular layout you want to keep (for example if you've positioned fixtures in the

window to match the layout on stage), open the Window Appearance menu using the Cog button and set Button Size to [Button Size Set Rows & Columns]. You can then set a fixed layout using the [Rows] and [Columns] buttons.

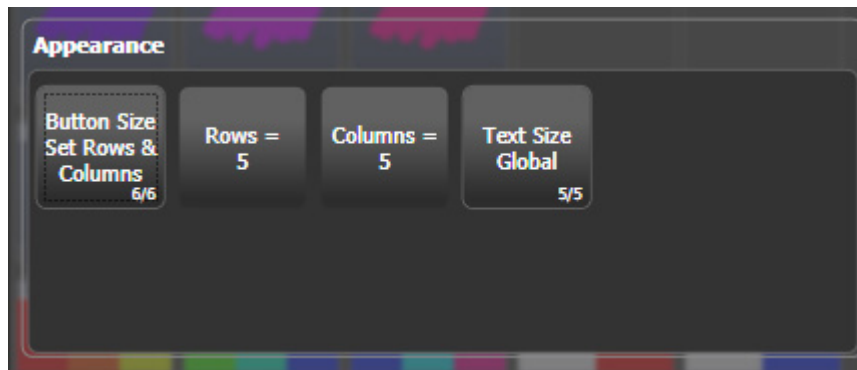

The Rows and Columns settings are remembered even if you change the button size back to one of the automatic sizes, which allows you to swap between auto and fixed button size modes.

3.2.2 MINI SCREEN (ARENA ONLY)

The <Display> button below the rotary encoders toggles through four fixed layouts for the Mini screen:

1-Workspace window(s) with encoder legends on the right

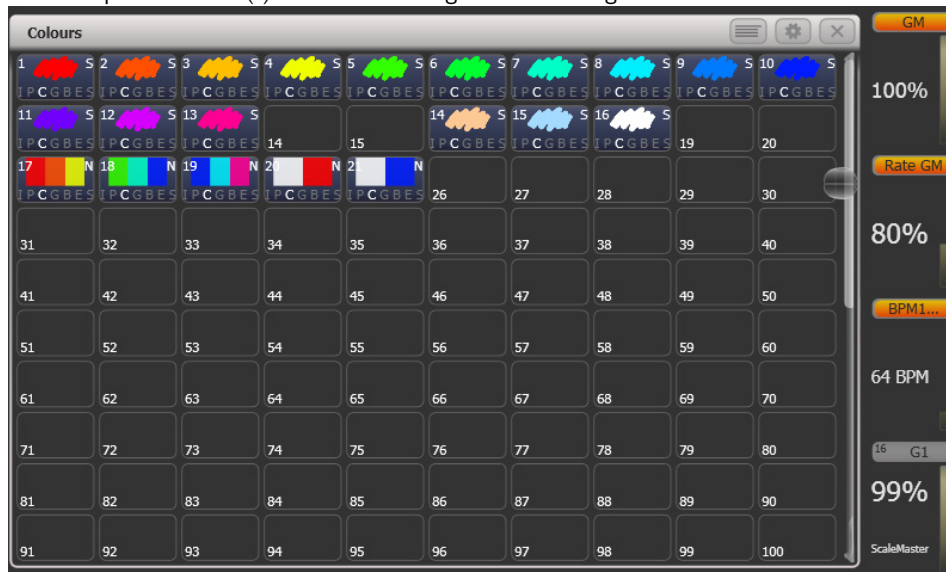

2-Workspace window(s) with macro button legends below

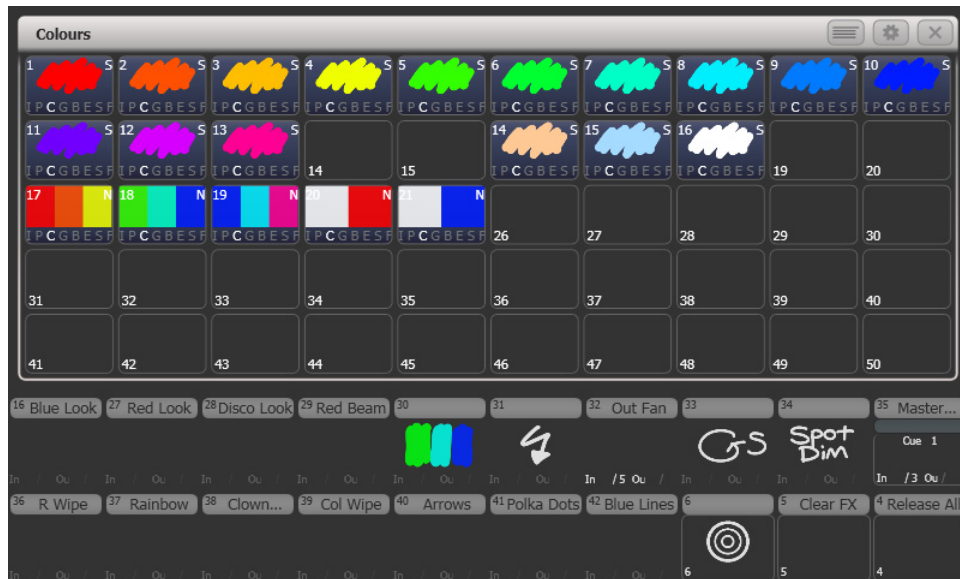

3-Fixed playbacks window - in this mode the first two rows of touch buttons are the same as the macro buttons below. This window cannot be moved to another screen, and other windows open on the Mini screen will move to the main screen when this layout is set.

4-Workspace window(s) fill the full screen, no button/encoder legends shown.

3.2.3 SAVING WORKSPACE LAYOUT

You can save workspaces, allowing you to reconfigure all the screen displays at the touch of a button.

Workspace layouts are saved to the Workspaces touch buttons to the left of the A-G menu buttons (except on Sapphire Touch and Titan Go where they are down the left side of the screen). Press <View/Open> then [Record Workspace], then touch one of the Workspaces buttons, or just touch an empty button twice to Quick Record. You can also save workspaces onto any grey handle or macro button.

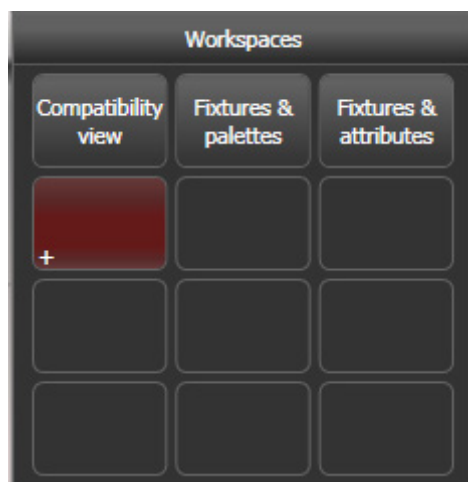

Workspaces are saved with the show.

As an example of setting up a workspace, suppose while programming you wanted to be able to access fixtures, position palettes, fixture attributes and shapes:

- 1> Press <Exit> to get to the root menu then the [Open Workspace Window] menu softkey.
- 2> Find the [Fixtures] window in the list and press it.
- 3> If the window is not in the top left quarter, press the Size & Position button (above the numeric keys) until the window occupies the top left quarter.
- 4> Press [Open Workspace Window] again and select the [Positions] window. Press the Size & Position button to position it in the desired location.
- 5> Repeat to activate the [Attribute Control] and [Shapes] windows.
- 6> Press <View/Open> then [Record Workspace], or hold <Avo> and press <View/Open>. Type in a name for the workspace. Then touch the Workspace button where you want to store this workspace layout. Or, you can use Quick Record – just touch an empty workspace button and it will turn red with a +. Type a name for the workspace and touch again to store it.

- [Record Visible/All Windows] lets you set whether the workspace will contain only the windows which are currently visible, or will also include any windows which are hidden underneath other windows.
- [Remove/Leave other windows on recall] sets whether all other windows will be closed when this workspace is recalled.
- To delete a workspace button, press <View/Open>, <Delete>, then the workspace button to be deleted.

3.2.4 COMPATIBILITY WINDOWS FOR PEARL EXPERT SHOWS

The “Fixtures and Playbacks” and “Groups and Palettes” windows allow you to access the preset fader handles in shows which have been programmed on the Pearl Expert.

When either of these windows is opened, there is a context button option to [Move to workspace]. This will move the handles from the compatibility window to the appropriate workspace window. You need to do this twice, once with the “Fixtures and playbacks” window selected, and once with the “Palettes and groups” window selected.

3.2.5 QUICK RECORD

Some windows – Groups, Workspaces, Playbacks, and all the Palette windows - have a Quick Record function. Set up what you want to record, then touch or click an empty button once. The button will light up red with a + sign. At this point you can enter a legend. Touch or click again to store the item.



The Quick Record function can be disabled using Key Profiles (see section 16.3.1 on page 322).

3.2.6 LEGENDS AND PICTURE LEGENDS

All touch buttons can have legends set to remind you what they do. In addition, you can draw picture legends on the buttons. To do this, select [Set Legend] then press [Picture].

A drawing space will open on the touch screen for you to draw the legend. There is also a library of pictures to choose from including popular gobo designs.

Colour palettes will automatically create a picture legend showing the colour(s) in the palette when you save it. Gobo palettes will show an image of the standard gobo, if the fixture personality has this information in it.



3.2.7 BUTTON HALO

You can set a custom coloured halo for fixture, group or palette buttons. This can be really useful for identifying different types of button at a glance. Select the [Halo] option on the Set Legends menu.

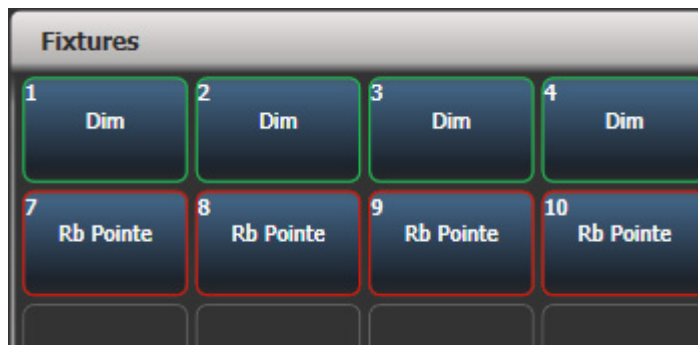

If you set a halo on fixture buttons, the halo colour is also used in other windows; fixture buttons can also have an automatic halo to help identify different types of fixture. There is more information on fixture halos in section 4.2.6 on page 98.

3.2.8 TRACKBALL (SAPPHIRE TOUCH ONLY)

The trackball on the right of the console can be used either to control the mouse pointer on the touch screens and external monitors, or to control fixtures.

To use in mouse mode, hold the <Assign> button below the trackball and click the 'Left' mouse button. The trackball will then control the mouse pointer and the ring will scroll windows up and down.

To use in console mode for controlling fixtures, press the <Assign> button on its own. The trackball will control pan and tilt of selected fixtures, and the ring controls fine tilt.

3.2.9 TOUCH KEYBOARD

At the end of the toolbar is the keyboard popup button which will open the touch keyboard.

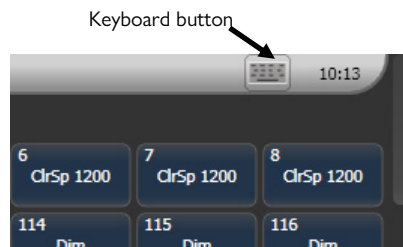

The touch keyboard can be switched between large and small size using the Max/Min button and you close it using the large X button in the top right hand corner. You can also move it on the screen by touching and dragging the blank area of the keyboard at the top.

If you want the keyboard to pop up automatically when text input is required, set the Man/Auto button to "Auto". This setting will stay active until you change it back to "Manual".

The small version of the keyboard (pictured) does not have some of the less frequently used buttons.

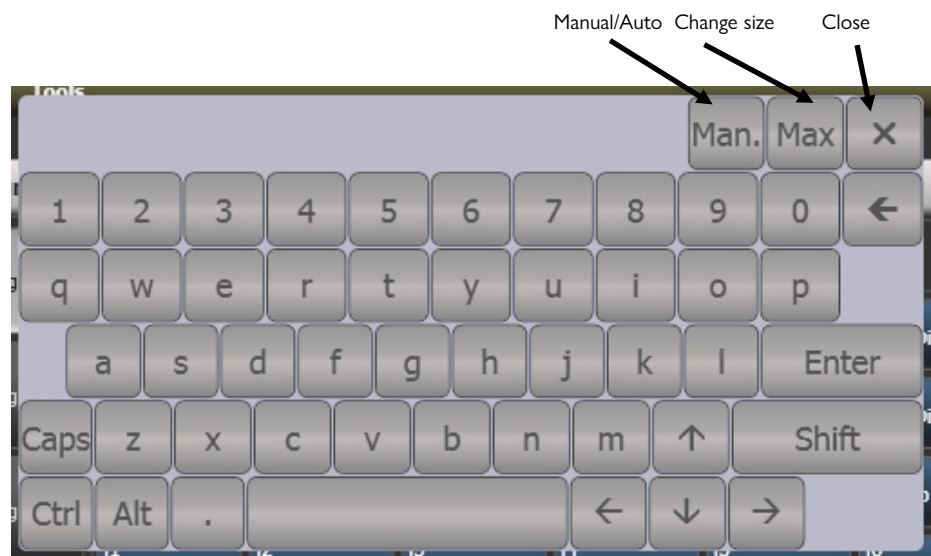

3.3 OTHER PARTS OF THE TOUCH SCREEN

3.3.1 THE MENU/SOFTKEYS

(Except Pearl Expert, which has a dedicated display for the menu)

The right hand side of the touch screen is used for the operating menu display. These are known as the "Softkeys" and are lettered A-G.

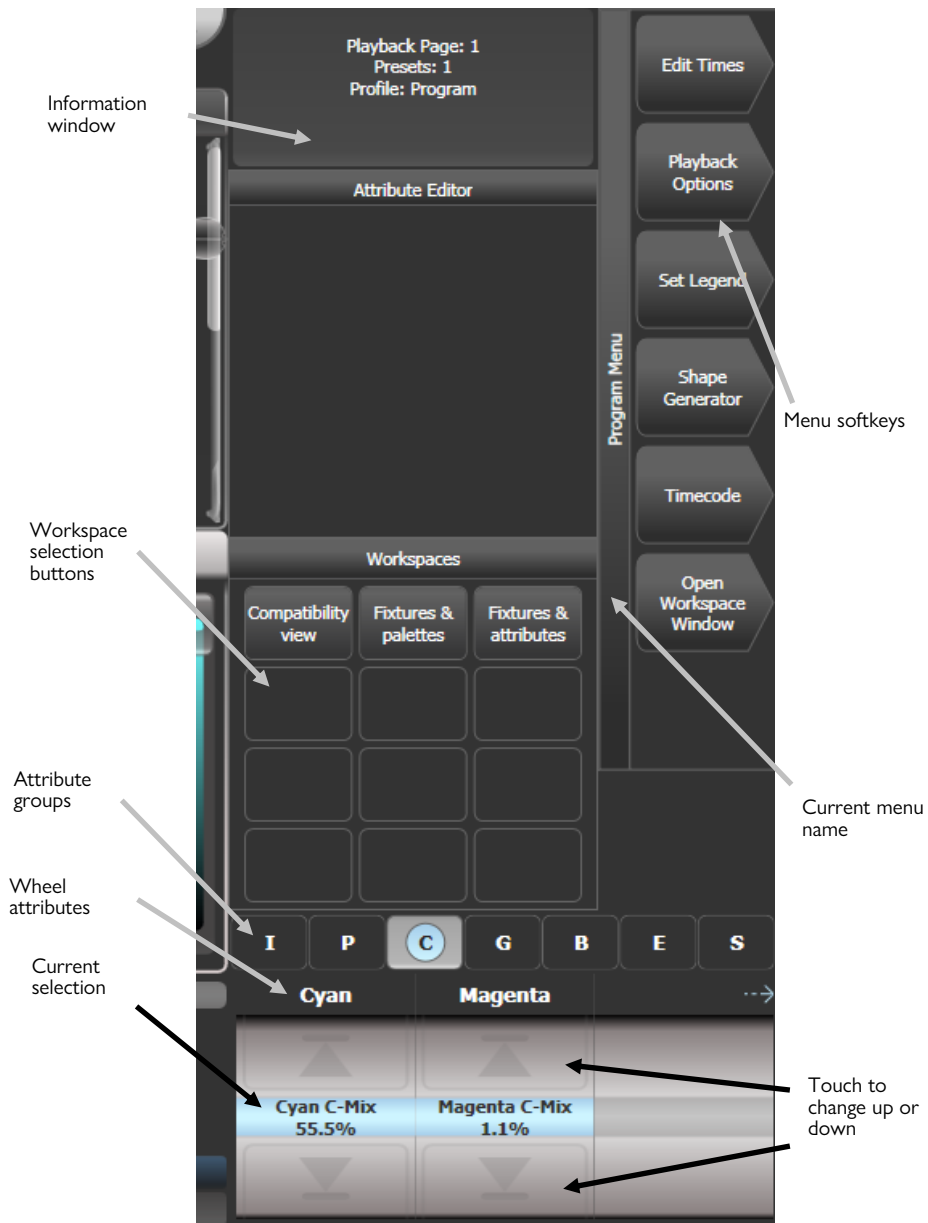

If there are more functions than will fit on one screen, [Previous] and [Next] buttons are provided to page through the functions. You can either touch the key on screen, or most consoles provide real buttons next to the screen.

The vertical bar to the left of the softkeys shows you which menu you are currently in. You can 'latch' the menu to keep the current command active (so that you don't have to keep reselecting it) by pressing the Menu Latch button (ML Menu on Pearl Expert & Tiger Touch Mk1). The menu bar turns red when latched.

The area to the top left of the menu buttons with an Avolites logo in the background is the system prompt area which shows instructions to the user and information from the console. The last commands you used are also shown here, for use with the Undo function.

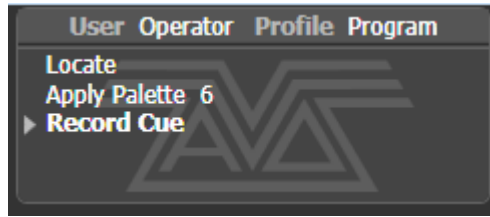

On the screen above the control wheels, the current function of the wheels is shown on a simulated roller. If fixture attributes are being set, this shows the possible settings which are available on the fixtures. Above the roller image a legend shows which attributes are being controlled by each wheel and the centre of the roller shows the current attribute. Touch the upper or lower segment of the roller to set the attribute to maximum/minimum.

If a chase is being controlled, information about the chase is shown here.

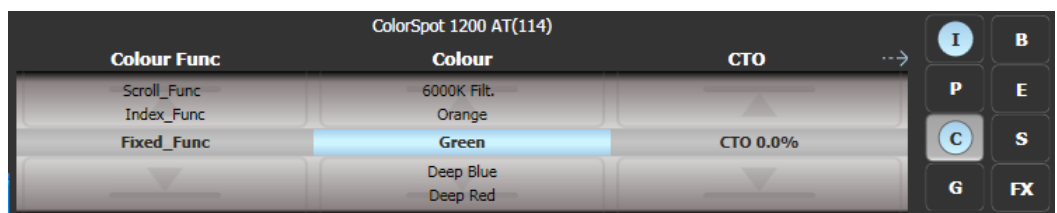

To the right of (Sapphire Touch) or above (other consoles) the roller, the screen shows which attribute group (IPCGBESFX or Intensity, Position, Colour, Gobo, Beam, Effect, Special, FX) is selected (grey box) and which are currently modified (blue circle).

The appearance of the softkeys varies to indicate the type of actions available:

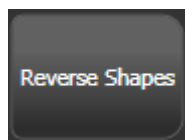

Action button: console will carry out the action shown

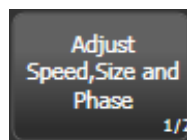

Option button: cycles through a range of options

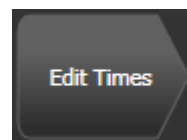

New menu button: jumps to a new menu

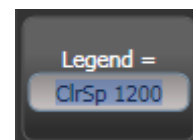

Text entry button: press and enter text using the touch keyboard

3.3.2 THE TOOLBAR

On all consoles except Sapphire Touch, across the very top of the screen is the toolbar.

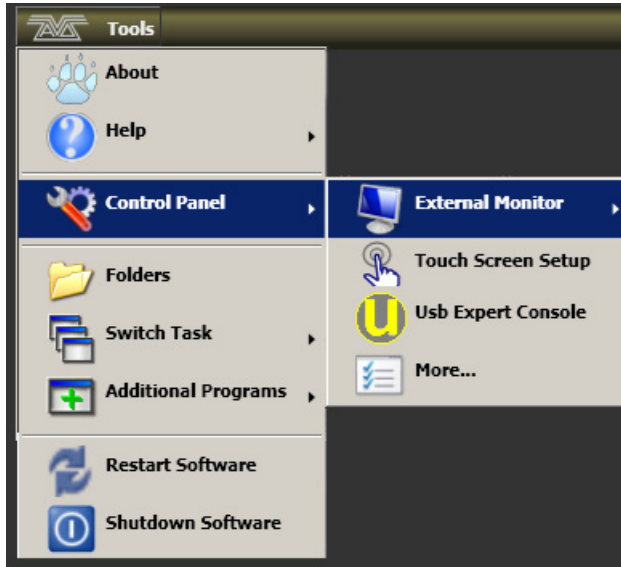

On Sapphire Touch the toolbars are shown vertically where the 2 screens meet in the middle.

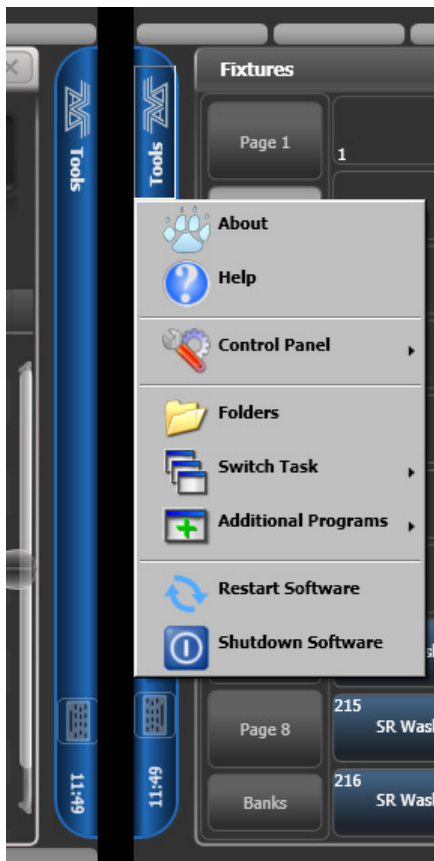

If you click/touch on 'Tools', you will get a menu giving you access to some configuration functions (these options may change slightly depending on the console).

About gives you information about the software version.

Help shows you the online manual.

Control Panel opens a sub-menu allowing changes to monitor settings and to the USB expert console which links the front panel controls to the system. The 'More...' option opens Windows Control Panel allowing you to change the operating system configuration.

Touch Screen Setup (in Control Panel) opens the setup utility which allows you to align touch positions on the screen. See next section.

Usb Expert Console (in Control Panel) sets up the connection between the front panel controls and the software. If you are having problems this can be used to troubleshoot.

Folders opens the file explorer. You might need this when backing up show files or when updating the operating software.

Switch Task allows you to show other programs (may be needed when upgrading software) on the touch screen or move them between screens. Touch the Switch Screen icon to swap the program between different screens. Touch the Centre icon to centre the window on the screen. Touch Close to close the program. The appearance of this window varies depending on the console.



Switch Software allows you to run different versions of Titan software (which you will need to install yourself, different versions are not installed by default). This can be useful if you need to load shows from older versions.

Additional Programs allows you to run some diagnostic programs which might help Avolites Support find problems you're having.

Restart and **Shutdown Software** restarts and closes the Titan software. You would normally only need to use these when upgrading the software.

The toolbar also has a keyboard button allowing you to pop up the touch keyboard.



Toolbars are not provided on Titan Mobile or Titan Go as all these functions can be carried out using standard Windows operations.

3.3.3 THE HEADS-UP DISPLAY (HUD)

The HUD window shows details of what's stored in all the handles (faders and buttons) on the console.

Fixtures are highlighted in dark blue if in the programmer and in light blue if selected.

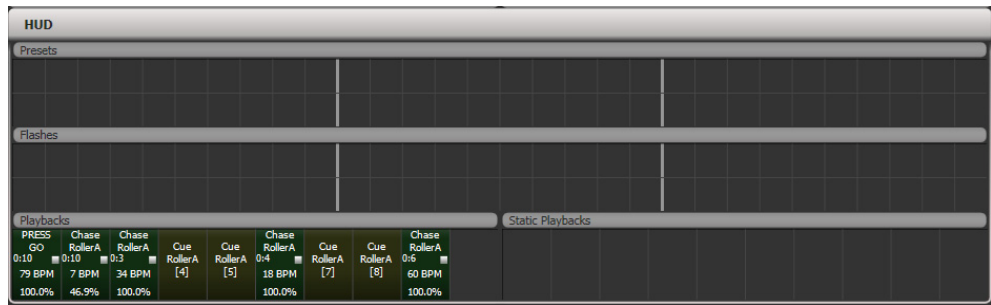

3.3.4 VISUALISER

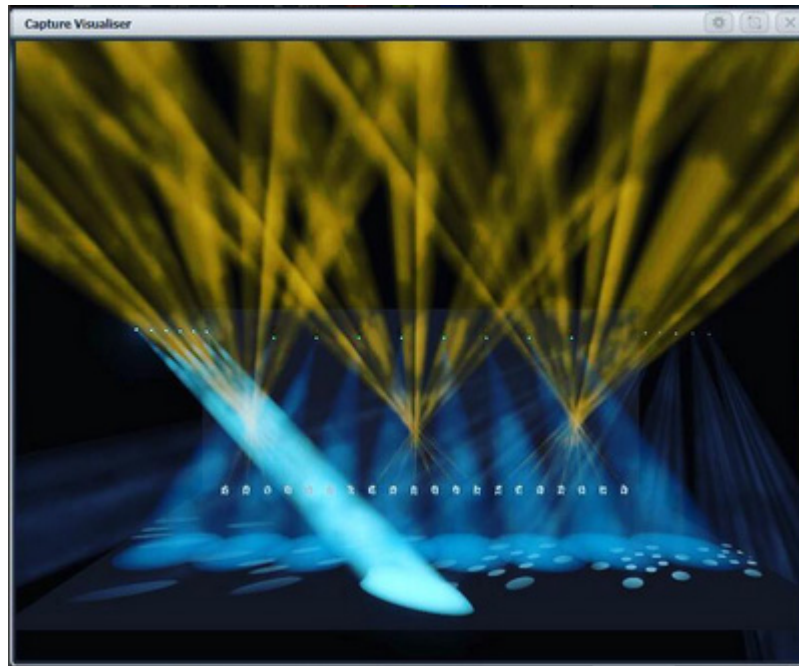

Capture visualiser is integrated into Titan from v10. .

The visualiser gives you a realistic view of the stage, allowing you to pre-program or make changes to your show at home or in your hotel. It can also be used in Blind mode for programming during a show.

The visualiser is described in detail in chapter 11 on page 261.

3.3.5 UNDO/REDO

A short list of recent actions is shown in the prompt area to the left of the menu.

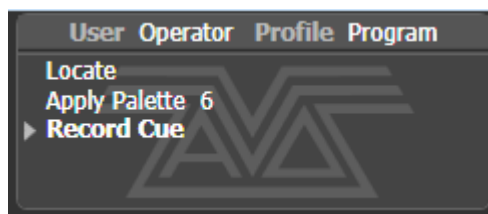

You can undo and redo recent actions (including fixture and cue changes) by touching the prompt area. This will automatically open the Undo History window which shows a more detailed list of actions you can undo.

The current action is shown in red in the Undo window and in bold in the prompt.

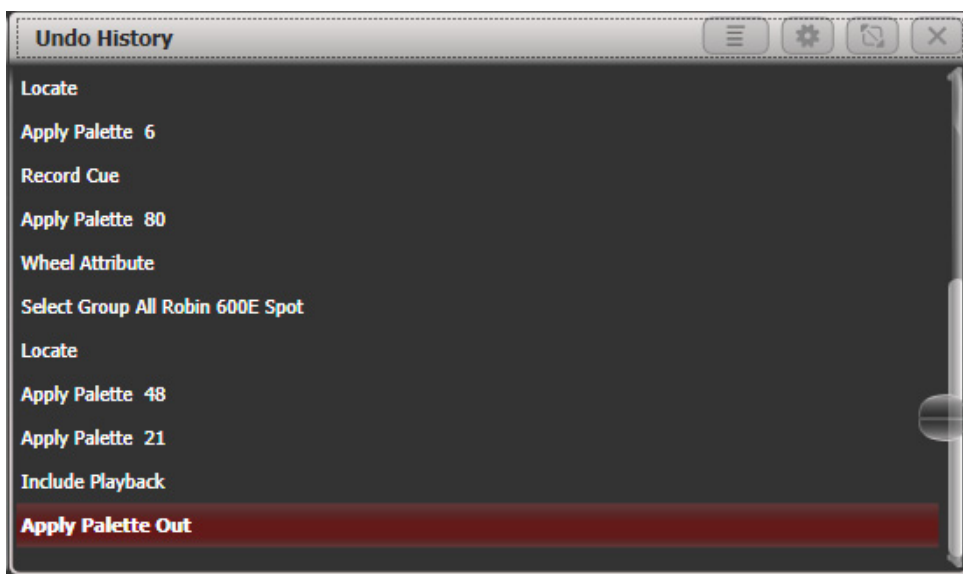

You can touch this window to undo all actions up to the one you touch. Once actions have been undone they are shown greyed out, and can be redone by touching them.

You can also use the <Undo> and <Redo> buttons (not on all consoles) to step through the list.

Some actions cannot be undone which is indicated with the “not allowed” symbol as shown below.

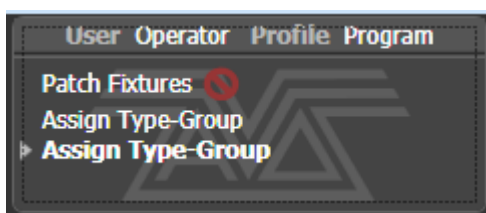

If you are in multi-user mode, the Undo History can show a column for each user with undo points for that user – open the Context menu and select [Show All Users and Consoles]. The default setting is [Show Only Current User].

3.4 FRONT PANEL BUTTONS

The blue and grey buttons associated with fader handles, and the macro/executor buttons are configurable and you can use them in various ways.

3.4.1 KEY PROFILES

The console allows you to change the function of the blue select and grey flash panel buttons (and the black buttons on Sapphire Touch). You can also change the way some of the touch keys work. You can save your settings as a Key Profile. Different profiles can be selected for different users or to enhance the operation of the console for a particular use. See section 16.3 on page 322 for details.

3.4.2 KEY MACRO BUTTONS

Lighting programming can sometimes require a repeated sequence of button presses. You can record sequences of keypresses and play them back with a single keypress – this is called a macro. The macro can reproduce the timing of your button presses (Real Time mode) or just repeat the sequence of buttons with no timing (Full Speed mode).

Real Time mode is useful when you are using a macro to reproduce a lighting effect, for example a sequence of flash buttons. Full Speed mode is more useful for admin tasks such as changing console mode.

Macros can be stored in the dedicated buttons on the top right of the panel, on the grey handle buttons, and in the Macro button window which can be shown in the workspace. The top right panel macro buttons correspond to the first 20 macros in the window (10 on Tiger Touch).

The Arena also has two additional Macro buttons on the bottom left corner of the console.

To record a macro:

- 1> Press the <Macro> button (above keypad)
- 2> Select [Full Speed] or [Real Time].
- 3> Press [Record]
- 4> Press a suitable empty button on the panel, or an empty button in the Macro window on the screen. Recording starts. The Insert/Macro button flashes during recording.
- 5> Press the sequence of buttons you want to record.
- 6> Press [Record Macro] to finish recording.

To play back the macro, just press or touch the button where you recorded the macro. The macro will repeat all your button presses, with correct timings if you selected Real Time mode.

3.4.3 KEYBOARD SHORTCUTS

Many features of the console can be controlled by shortcuts on the keyboard. These are especially useful when using Titan Mobile or Titan Simulator.

The Titan application “captures” the keyboard on start up, meaning that if you try to use other applications at the same time they will not receive keypresses. Pressing Break on the keyboard releases the keyboard for other applications but disables all text entry for Titan including the shortcut keys; changing menus will reconnect the keyboard to Titan.

Shortcuts are shown on the next page.

F1	Open user manual	Ctrl X	Cut text
F2	Activate window	Ctrl C	Copy text
F3	Minimise/Maximise	Ctrl V	Paste text
Shift F3	Next window	Ctrl A	Select all text
F4	Size/Position	Ctrl Z	Undo
Shift F4	Move to other screen	Ctrl Y	Redo
F5	Close window	Alt C	Clear
Shift F5	Close all windows	Alt R	Record menu
F6	Open Playbacks window	Alt A	Toggle Avo (shift) menu
F7	Open Fixtures window	Alt L	Locate
F8	Open Groups window	Alt P	Patch
F9	Open Colours window	Alt ↑ D	Disk menu
F10	Open Positions window	Alt ↑ S	System mode
F11	Gobos/Beams window	Alt V	Open/View menu
F12	Open Channel Grid	Alt G	Go
Esc	Exit menu	Alt D	Delete
Enter	Enter	Alt ↑ C	Copy
Alt 1	Softkey A	Alt M	Move
Alt 2	Softkey B	Alt U	Unfold
Alt 3	Softkey C	Alt I	Include
Alt 4	Softkey D	Alt ↑ R	Release
Alt 5	Softkey E	Alt S	Shape
Alt 6	Softkey F	Alt T	Fixture Tools/ML Menu
Alt 7	Softkey G	Alt B	Blind
Alt ↑ F	Fixture	Alt O	Off
Alt ↑ P	Palette	Alt F	Fan
Alt ↑ M	Macro	Alt ↑ O	Attribute options
Alt ↑ G	Group	Alt ↑ L	Latch menu
/ (num)	Thro	Alt ←	Previous fixture
* (num)	@	Alt →	Next fixture
- (num)	Not	Alt ↑	All
+ (num)	And	Alt ↓	Highlight

↑ means shift

(num) means on the numeric keypad

3.4.4 LOCKING THE CONSOLE

You can place a simple lock on the console controls to prevent people fiddling with it while you're not looking. Hold down <Avo> and press [Lock], then type a password (numbers or letters). To unlock, enter the password again, or restarting the console will also unlock it. After a few seconds, the "Enter password" prompt will fade out but will appear again if you press buttons or touch the screen. This is not a high-security lock, it's just to prevent passing idiots messing with it.

You can set a background image for the lock screen from the Lock Screen Background option in the General tab of User Settings (hold <Avo>, press [User Settings]). The image can be either loaded from a picture file or drawn using the touch screen.

If you load a picture file, the menu option [Scaling Mode] sets how the picture will be scaled to fill the screen.

- None: Image is displayed 1:1
- Letterbox: scales the image until it fills either the width or height of the screen, leaving black bars on the other edges of the screen.
- Fill: scales the image until it fills the whole screen, keeping the aspect ratio
- Stretch: scales the image until it fills the whole screen, ignoring the aspect ratio

The [Clear] softkey will remove the image.

While the console is locked, all functions are disabled except the DMX outputs and currently running playbacks.

3.5 MULTI-USER OPERATION

You can connect multiple consoles together to work together on a show. You can also have multiple user setups on a show on a single console to allow different layouts, for example for a support band LD.

3.5.1 USERS

Each show can have multiple users. Each user has their own user settings, key profiles and handle layout (known as a *handle world*). This provides a quick way to switch between preferred user settings and handle layouts, for example at a festival or other event where there are a number of operators.

Users are stored in the showfile and the currently selected user is restored when loading a show. The default user is called "Operator" and the prompt area in the display shows the current user name and selected key profile.

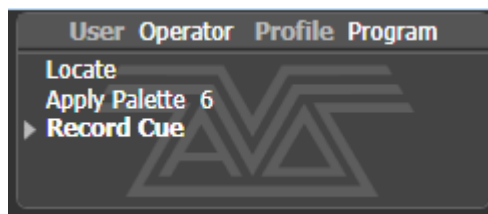

To change or create users, go to the Users menu.

- 1> Press the <Disk> button.
 - 2> Press [Users].
 - 3> To switch to a different user, press [Change Current User] and select a new user from the list (the current user is highlighted).
 - 4> To create a new user, press [Add a User], enter a name for the new user and press [OK].
 - 5> You can also quickly change user from the root menu by holding <Avo> shift and pressing [User ...]
- If multiple consoles are connected in a collaborative session, any user added to one of the consoles will be available on any of the other consoles.

3.5.2 HANDLE WORLDS

Each show can have multiple Handle Worlds, each having its own layout of handles. This allows each user to have their own layout of cues, palettes and chases which can be easily switched, for example when a support band and headline band are using the same console, or when multiple programmers are working collaboratively on a number of consoles.

When a new user is selected, the handle world they were using is also loaded.

All handle worlds are stored within the showfile, the default handle world is called "Mapping World 1".

Handle Worlds are managed from the Disk menu.

- 1> Press the <Disk> button.
 - 2> Press [Handle Worlds].
 - 3> To switch to a different handle world, press [Select Handle World] and select a new handle world from the list (the current one is highlighted).
 - 4> To create a new handle world, press [Add Handle World], enter a name for the new world and press [OK].
 - 5> [Delete Handle World] will delete the world, any handles used only in that world will become unassigned (and can be retrieved using the Show Library if needed).
- Items created in a different handle world can be accessed using the Show Library workspace and assigned to handles in the current handle world.
 - The [Follow World Page Change] option sets whether the handle page will change if a user using the same handle world on another console changes the page.

3.5.3 LINKING TO OTHER TITANNET SESSIONS

If multiple Titan consoles are connected in the same network you can choose to connect them as multi-user, backup, or both. This is also how you connect TitanNet processors to expand DMX outputs.



All consoles to be linked must be running the same version of Titan for this to work.

For details of how to connect Titan consoles together on a network, see section 18 on page 345.

- 1> Press the <Disk> button.
- 2> Press [TitanNet Sessions].
- 3> [Sessions View] opens a window that shows you how your console is connected to others, and what other TitanNet sessions are available. You can touch on another console in the window and click [Connect] to start a connection, or use the other buttons to leave a session.
- 4> Or select [Backup], [Multi-User] or [Backup & Multi-User] to show a list of sessions which you can connect to. Click on the session to start the connection.

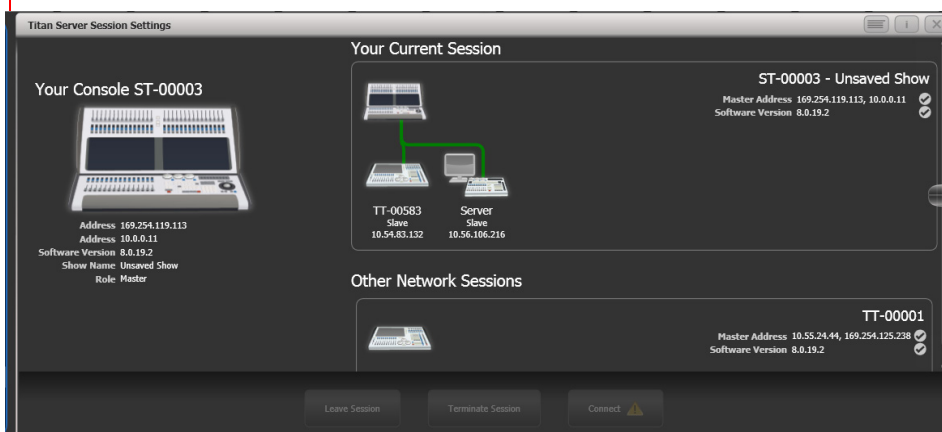

- A green line shows a good connection, a dotted red line shows a problem with a connection. Unavailable consoles are shown with a red background.

Initially all consoles are “Master” consoles. If you connect to a session on another console as multi-user you become a “Slave” on that console. The show on the Master is transferred across the network to the Slave. On the Slave you can choose to save the show locally or to save changes back to the Master console.

The toolbar will show details of the master/slave status. Console legends can be changed in the System menu using the [Console Legend] option.



Consoles connected in a multi-user session work on the same show. If the same handle worlds are selected then an action on one console is mirrored across them all, for example firing a cue on the slave console will also fire the cue on the master. If the master has motorised faders, the fader will move; if not, fader levels must match before they can take over. If different handle worlds are selected, users can work independently on their own pool of handles.

In all situations the master console outputs DMX and channels in a remote programmer are shown with a blue dot on the touch wheel views. If two or more consoles are editing the same fixture, the last console to change any attribute will take over control of the fixture.

Slaves can leave a session using the [Leave Session] button in the Sessions View or in the TitanNet menu. The console will restore the local show it had loaded prior to joining. Master consoles have the option to [Terminate Session].

If a console is running as backup, it has options to [Takeover], [Sync now] and [Leave Session]. If [Takeover] is selected, the console will immediately become the master and take over DMX output with the chosen user and handle worlds selected. The console which was master will go into a dormant state with DMX disabled.

- Consoles must be running Titan v8 or above to join a multi-user or backup session with another Titan v8 console.
- Backup operation is also described in section 13.7.2 on page 303.

For Titan Mobile:



Network Discovery must be enabled in the Windows User Profile you are using or consoles will not be able to see each other on the network. Ensure the Windows option 'Turn on network discovery' is selected in the Network Sharing options.

3.6 TITAN SIMULATOR

Need to pre-program or tweak your show before you get to the venue? No problem, just run the Titan Simulator on your PC. You can then load your show and simulate any of the Titan consoles, using an on-screen “virtual panel”.



3.6.1 INSTALLING TITAN SIMULATOR

You will need a Windows user account with Administrator privileges to install or run Titan Simulator. From v12, to run the Titan Simulator an AvoKey Simulator dongle must be connected, or a T1/T2 device.



From v7, Windows XP and Vista are no longer supported by Titan software. Your PC must be running a 64 bit version of Windows 7, Windows 8.1 or Windows 10.

Capture visualiser requires a capable graphics card. If you have problems with Capture, ensure you have installed the latest drivers for your graphics card from the manufacturer.

Simply download and run the Titan PC Suite installer from the Avolites website. The first time you run the Editor you will need to license the software to the AvoKey; follow the instructions given on screen by the Authenticator system.

Once licensed, you have a choice of how Titan will operate:

- If you run Titan Go with an Editor/Simulator AvoKey, you will get one universe of DMX (via Art-Net) with no spoilers. With a T1 or T2 connected you will get one or two universes of DMX via XLR and Art-Net with no spoilers.
- If you run a simulated console, you will get full DMX output on all universes but periodically random DMX values will be sent down all DMX outputs as a “spoiler”, please wait for this to stop before continuing programming.

3.6.2 RUNNING TITAN SIMULATOR

When you start Titan Simulator you need to select which console you are simulating. The simulator will then open a Virtual Panel, which replicates the physical controls of your chosen console, and monitor windows for each of the monitor outputs.



The touch screen display is shown separately from the Virtual Panel. It is helpful to have two monitors to allow you to see the touch screen and the Virtual Panel at the same time.

The Virtual Panel works exactly the same as the real panel; to hold a button down so you can press a second button, right click it using the mouse.

3.6.3 USING VIRTUAL PANEL WITH A CONSOLE

As well as its use with the simulator, you can also run the Virtual Panel on a console. This could be handy to keep things going if you are suffering hardware problems with the real console controls.

To show the Virtual Panel, click the Tools menu on the toolbar, then select Other Programs, then Virtual Panel. The Virtual Panel controls will work in parallel with the real controls.

3.7 SHOW LIBRARY

The Show Library window collects all the information about your show into a single place. It is very useful to transfer programming when importing parts of previous shows, or when moving shows to a Titan consoles with fewer faders, but can also be used to move items around within your show.

Press <View/Open> then [Open Workspace Window], [Show Library] to open the window (or if in the root menu just [Open Workspace Window], [Show Library]).

3.7.1 SHOW LIBRARY TAB

The Show Library lists all programmed elements of your show including fixture patch, fixture groups, palettes, playbacks, macros and workspaces. Use the buttons down the left hand side to filter what types of information are displayed.

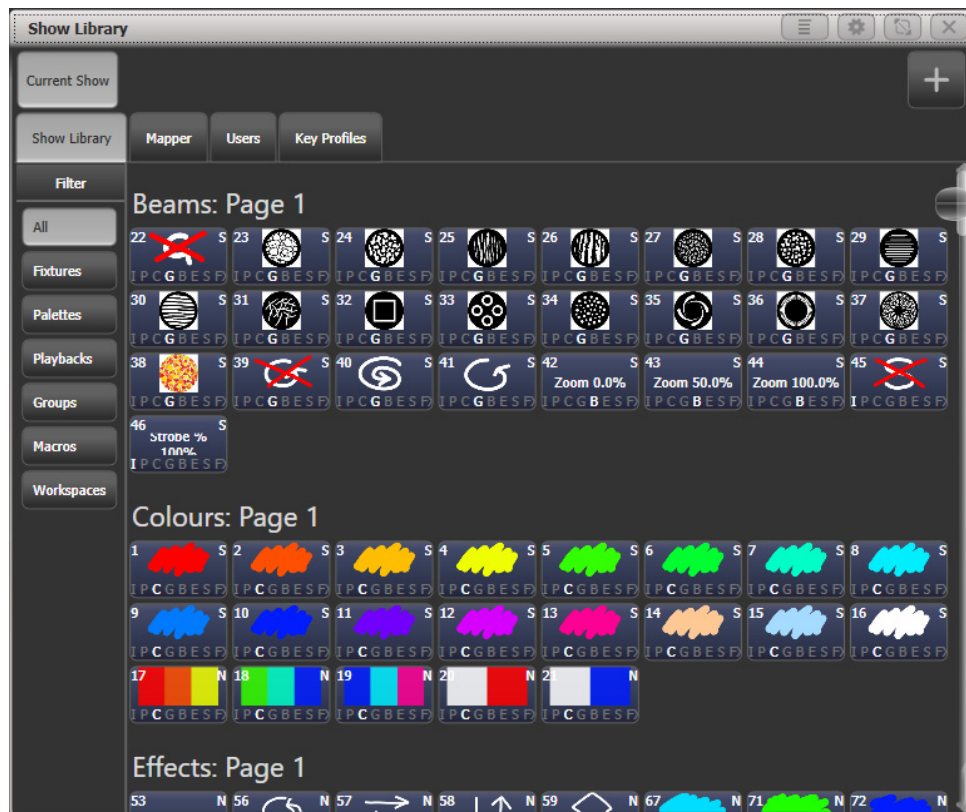

Clicking on the buttons in the Show Library window will activate them.

3.7.2 MAPPING SHOWS FOR IMPORT

Press the Plus button top right to map another showfile to allow you to import elements of it.

Using the Mapper tab you can map similar fixtures from an imported show to the current show. This lets you load in your favourite programming from other shows. See section 3.8.3 on page 81 for more details.

3.7.3 USERS TAB

This tab allows you to set up and select users for the console. This is the same as the [Users] option found in the Disk menu.

3.7.4 KEY PROFILES VIEW

Selecting the Key Profiles tab shows all information about the different Key Profiles available on the console. The available profiles are listed down the left hand side, and the key allocations are shown on the right. You can't change the Key Profiles using this screen, it's just for viewing the settings. Key Profiles are described fully in section 16.3 on page 322.

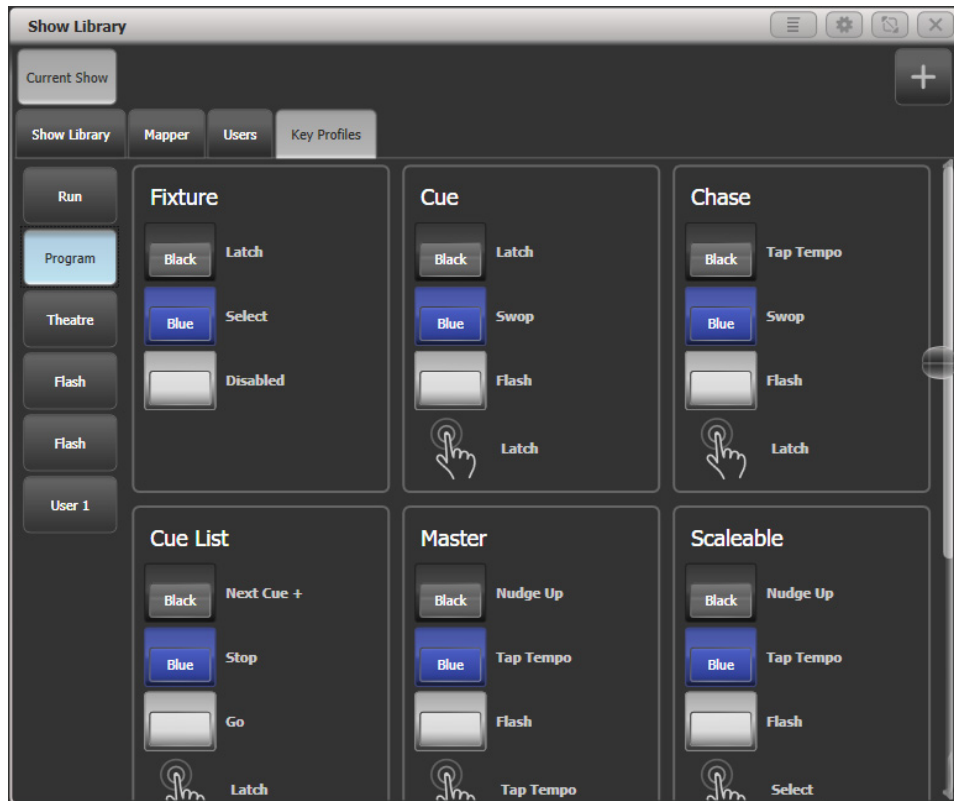

3.8 LOADING AND SAVING SHOWS

You can save any number of different shows on a USB drive or the console's internal hard disk. The console will also autosave the show periodically.



Shows created on a Titan console can be loaded into any other model of Avolites Titan console, but not to older non-Titan consoles as the showfile format is different.

Showfiles from newer versions of Titan may not load correctly (or at all) into consoles with older versions of Titan.

Although your show is safe on the hard disk, it's a good idea to also save it to a USB pen drive which you can take with you in case something bad happens to the console or if you want to transfer a show to a different console.

3.8.1 SAVING THE SHOW

You can save your show at any time either with its current name or with a new name. If you save your show with its current name, a new version of the show will be created. This allows you to go back to previous versions of your show if needed.

To save your current show:

- 1> Press the <Disk> button.
- 2> Press [Save Show].

- 3> If you have a USB drive connected, use the softkeys to select whether to save on [Removable Disk] or [Internal hard drive].
 - 4> If this is a new show, enter a name for the show on the keyboard. If this is a new version of an existing show you can enter a tag to help identify the version, which will be shown on the Show Browser screen when you load shows.
 - 5> Press <Enter> or [Save] (or [Overwrite] if the show already exists). The show will be saved.
 - 6> Press <Exit> or [OK] to leave Disk mode.
- To save the show under a different name, use the [Save As] softkey.
 - Pressing the <Disk> button twice will make the console save a Quicksave version of the file. A Quicksave is just a version of the show saved with the same filename.
 - A new version of the file will be saved even if you enter the same tag as previously used.

If you save to hard drive, shows are saved in the folder 'D:\Shows' (on Titan Mobile, Titan Go and Simulator the folder is 'Documents\Titan\Shows').

3.8.2 LOADING A SHOW

The console will automatically reload the last show when it is turned on.

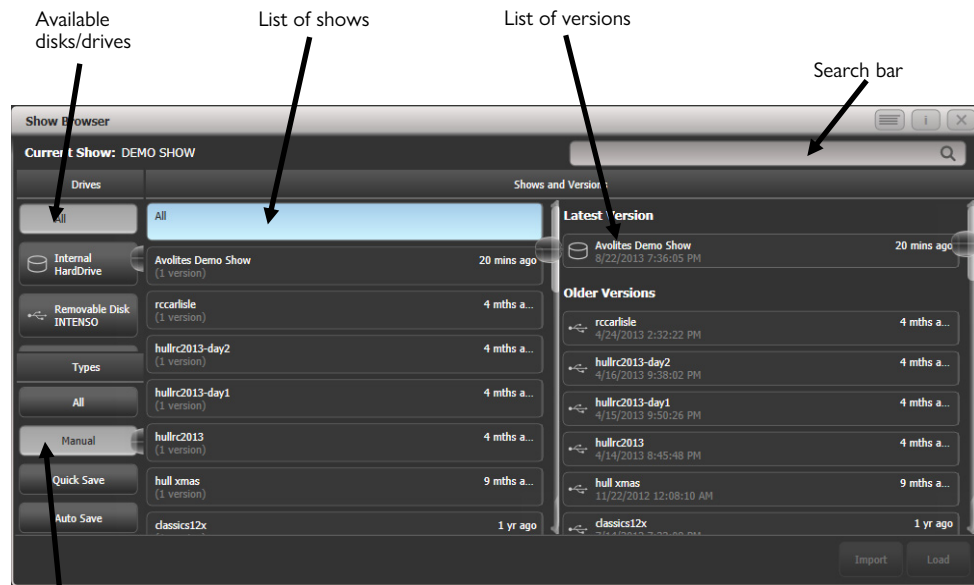

Filter list of shows

Press the <Disk> button then [Load Show] to load in a new show. The Show Browser window will appear.

On the top left you can select which drive is used, or show files on all drives. On the bottom left you can filter the list of shows to see all shows, or just manual saves, quick saves or autosave files. On the right you can see different versions of the showfile; this allows you to reload an earlier version if you need to.

You can also load shows from the softkeys:

- 1> Press the <Disk> button.
- 2> Press [Load Show].
- 3> If you have a USB drive connected, select which drive you want to load from.
- 4> Available shows are listed on the softkeys; press the key to load the show (the F and G keys show more pages). If you type the first few letters of the show name on the touch keyboard, the list will only include shows starting with those letters, which can make it easier to locate the show you want.
- 5> If there are multiple versions of the show stored on the disk, select the one you want.
- 6> Press Load Show. The console will show a loading screen as the different elements of the show load.
- 7> When the show has loaded the normal operating screen will reappear.

When loading a show you have the option to keep the existing DMX settings of the console, or to load the settings stored in the showfile. The DMX settings determine how the XLR sockets on the back of the console are used and how DMX is sent over the network using TitanNet.

3.8.3 IMPORTING PARTS OF OTHER SHOWS

If you are doing a show which is similar to a previous one, you might want to import parts of the previous showfile, for example you might want the palettes for some Robe Robins from another show, but not the other fixtures. This is where the Import Show function comes in handy.

For Import Show to work, you need to map fixtures from your imported file to fixtures in the current show so that Titan knows where to import the programming to.

The screenshot shows the 'Show Library' window with the 'Mapper' tab selected. The 'Current Show' is 'rccarlisle'. The 'Show Library' section has a 'Button for imported show' and an 'Import new show' button. The main area is a table with columns for 'Current Fixtures', 'Usr #', 'Address', 'Legend', 'Usr #', and 'Mapped Fixture'. Below the table are two lists of fixtures: 'Current Fixtures' and 'Imported Fixtures'. Arrows point to various elements: 'Filter fixtures in current show' (arrow to the left of the current fixtures list), 'Arrow shows mapped fixture' (arrow to the arrow in the 'Mapped Fixture' column), 'Fixtures in imported show' (arrow to the imported fixtures list), and 'Filter fixture list in imported show' (arrow to the left of the imported fixtures list).

Current Fixtures	Usr #	Address	Legend	Usr #	Mapped Fixture
All Fixtures	1	1.1	ColSp70EAT	1	ColorSpot 700E AT
Dimmer	2	1.37	ColSp70EAT		
ColorSpot 700E AT	3	1.73	ColSp70EAT		
ColorWash 575 AT Zoom	4	1.109	ColSp70EAT		
Palco 5	5	1.145	ColW575Zm	10	olorWash 575 AT Zoom
Wash 575 XT	6	1.401	ColW575Zm		
	7	1.177	Wash 575XT		
	8	1.193	Wash 575XT		
	9	1.209	Wash 575XT		
	10	1.225	ColW575Zm		
	11	1.420	ColW575Zm		
	12	1.257	Palco5		

The 'Imported Fixtures' list includes:

- 1.101 Robe ColorSpot 700E AT
- 1.137 Robe ColorSpot 700E AT
- 1.173 Robe ColorSpot 700E AT
- 1.209 Robe ColorSpot 700E AT
- 1.420 Robe Wash 575 XT
- 1.245 SGM Palco 5
- 1.261 Generic Dimmer
- 1.262 Generic Dimmer
- 1.263 Generic Dimmer
- 1.501 Generic Dimmer
- 1.502 Generic Dimmer
- 1.503 Generic Dimmer
- 1.504 Generic Dimmer
- 1.505 Generic Dimmer
- 1.506 Generic Dimmer
- 1.507 Generic Dimmer

You can then select items from the imported show and store them onto workspace or panel buttons in your current show.

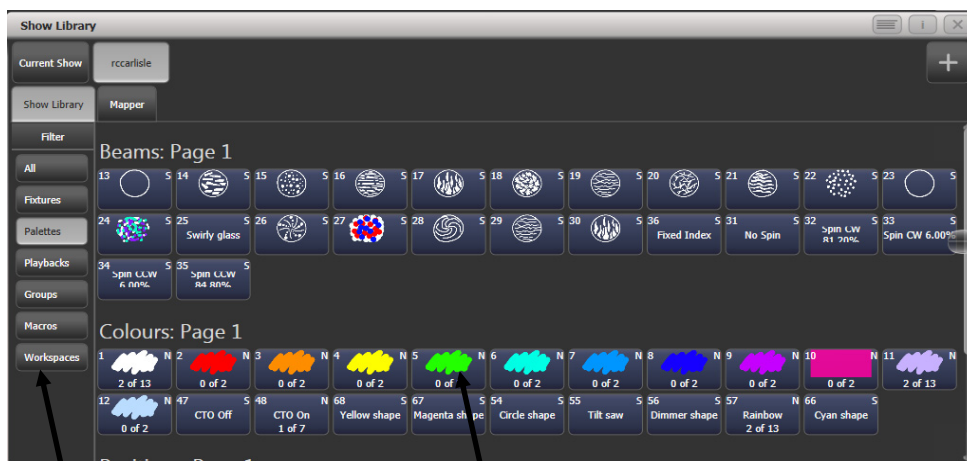

Filter display of items in show

The items which can be imported

- 1> Press the <Disk> button.
 - 2> Press [Import Show] (The plus button at the top right of the Show Library window also opens this menu).
 - 3> The Show Browser window opens. Select the show you want to import from and press [Load Show].
 - 4> The Show Library window will now open. Your current show and the imported show will appear as buttons at the top of the show browser. You can import items from more than one show at once by repeating steps 1-3.
 - 5> Click on the Mapper tab, and select your imported show.
 - 6> Select a fixture in your imported show, then click the arrow beside the fixture it maps to in the current show. To remove a mapping, click the [Clear Fixture Mapping] context button.
You can select multiple target fixtures by dragging a box over the fixtures, or click on the source fixture again and map to another target.
 - 7> When you have mapped all fixtures you want to import data from, click on the Show Library tab.
 - 8> Select the items you want to import (single or multiple). Use the buttons on the left to select Palettes, Groups etc.
 - 9> Select handle(s) where you want to store the imported items.
 - 10> When you have imported all the items you want, press <Exit>.
- You can filter fixture types to make the mapping easier using the buttons on the left and right sides of the show browser.
 - You can directly import shows without using the Disk menu by clicking the Plus button at the top right of the Show Browser.
 - There is more information about the Show Library window in section 3.7 on page 77.

3.8.4 AUTOSAVE

The console will automatically save your show to its internal hard disk when you shut it down. It will also autosave the show every 30 minutes in case the console loses power.

You can disable Autosave or alter the time between saves using option [Auto Save] on the Disk menu (press the <Disk> button). You can reload Autosave files using the Show Browser.



This option is included because Autosave used to make the console pause, however this is no longer the case and we recommend that you do not disable Autosave. If you lose power while programming Autosave will make your day a whole lot better.

3.8.5 RECOVER SHOW

If Titan shuts down improperly due to a crash or power failure, and when you restart it the most recent showfile can't be reloaded, a softkey option [Recover Show] will be displayed which will attempt to load the show from the temporary directory. You will also see options to start a new show or load a previous show.

3.8.6 BACKING UP EXISTING SHOW FILES TO USB PEN DRIVE

If you just want to save a copy of your current show, you can use the normal save function to save it to the USB drive instead of the hard drive.

To copy an existing show file on the hard disk to a USB drive, first ensure your current show is saved, then use the Disk functions to load the existing show from hard disk, then save it to the USB drive. Alternatively you can use the Folders command on the Tools menu.

3.9 CLEARING THE CONSOLE

When you start a new show on Titan it is usually a good idea to clear the console. All programming and patching is deleted, but user options are not changed.

- 1> Press the <Disk> button.
- 2> Press [New Show].
- 3> Press [OK] to confirm.
- 4> Press <Exit> to leave Disk mode.

- When starting a new show you have the option to keep existing DMX settings. This preserves the DMX/TitanNet configuration of the console which determines how the XLR sockets on the back of the console are used and how DMX is sent over the network.
- There is also an option [Wipe] in the System menu which has the same function, this option is provided for Avolites oldies who are used to the "classic" Avolites software.

3.10 CREATING REPORTS

When preparing a show it is often useful to create a report of how the show is patched or programmed on the console, for example to give to a crew when pre-rigging fixtures, or just for your records.



Showname: BELLOWHEAD NOV 2012 Preprog

Date: 05/04/13-16:30

Software Version: PREVIEW

Console Name: W174

Console Type: Titan Mobile

Patch View

User no.	Fixture	Mode	Address	Legend	Location	Pan Invert	Tilt Invert	Iris Invert	P/T Swapped
1	Robin 100 LEDBeam	Mode 1, 35 DMX	1.1	R100 LED B	Fixtures, 0.000	No	No	No	No
1.1	Robin 100 LEDBeam	1x RGBW cell, 8 DMX	1.7	Cell 1	, 0.000	No	No	No	No
1.2	Robin 100 LEDBeam	1x RGBW cell, 8 DMX	1.15	Cell 2	, 0.000	No	No	No	No
1.3	Robin 100 LEDBeam	1x RGBW cell, 8 DMX	1.23	Cell 3	, 0.000	No	No	No	No
2	Robin 100 LEDBeam	Mode 1, 35 DMX	1.36	R100 LED B	Fixtures, 0.001	No	No	No	No
2.1	Robin 100 LEDBeam	1x RGBW cell, 8 DMX	1.42	Cell 1	, 0.000	No	No	No	No
2.2	Robin 100 LEDBeam	1x RGBW cell, 8 DMX	1.50	Cell 2	, 0.000	No	No	No	No
2.3	Robin 100 LEDBeam	1x RGBW cell, 8 DMX	1.58	Cell 3	, 0.000	No	No	No	No
3	Robin 100 LEDBeam	Mode 1, 35 DMX	1.71	R100 LED B	Fixtures, 0.002	No	No	No	No
3.1	Robin 100 LEDBeam	1x RGBW cell, 8 DMX	1.77	Cell 1	, 0.000	No	No	No	No
3.2	Robin 100 LEDBeam	1x RGBW cell, 8 DMX	1.85	Cell 2	, 0.000	No	No	No	No

Reports can be created in HTML, PDF, CSV or XML formats for the following:

- Fixtures
- Memory (Cues)
- Chases
- Cue Lists
- Palettes
- Groups

To generate reports:

- 1> Press the <Disk> button.
- 2> Press [Reports].
- 3> Select the item(s) you want to include in the report
- 4> Select the format in which you want to output the report
- 5> Select the drive where you want to save the report

Reports are stored in the following folders:

PC suite (Editor/simulator, Titan Mobile., Titan Go): Documents/Titan/Reports

All other consoles: D:/Data/Reports

When the report is complete, Titan will open the folder where the report is stored so you can see where it went.

4. PATCHING

Patching is the process where you tell the console

- What type of lighting units you have connected to it
- What DMX addresses they are operating at
- Which DMX line (universe) each unit is connected to (there are 64 lines, but the console itself can only output 16 lines; further lines can be controlled using networked DMX processors over TitanNet)
- Which buttons on the console you want to use to access them (either physical buttons or touch buttons)
- Particular option settings for each fixture.



Before you start rigging, you can use the console to work out the DMX addresses for the fixtures in your rig. Patch them on the console (or simulator), then press <View/Open>, <Patch> to show the Patch View window. This will use the DMX channels as efficiently as possible without leaving any gaps.

If your fixtures are RDM equipped, the console can patch itself from the rig, see section 4.1.7 on page 92.

On consoles with a System/Run/Program switch, the switch must be set to Program before you can patch.

By default in a new show, each physical DMX output socket (5 pin XLR) is connected to a DMX line. If you want to change this or use other lines, go to the DMX Settings window in System mode – see section 16.1.2 on page 320 .



If nothing is happening to the lights when you make changes on the console it is worth checking the DMX Settings window to make sure the DMX lines are allocated to outputs.

4.1 PATCHING NEW FIXTURES OR DIMMERS

4.1.1 FIXTURE SELECT BUTTONS AND HANDLES

To control intelligent fixtures or dimmer channels, they must each be patched to a button (sometimes referred to as a “handle”). You can patch onto touch buttons in the Fixtures window, to a fader handle or to a Macro/Executor button. If the handle you patch to has a fader, the fader will control intensity.

If the Fixtures window is not shown, press <View/Open> then <Fixture> or press <View/Open> then [Open Workspace Window] then [Fixtures].



Fixture buttons can be shown either in pages with Page buttons, or you can use the scroll bar on the right to show different pages. Use the [Pages Show/Hide] button on the right of the screen to select between page buttons and scrolling mode. You can change the fixture page at any time.

You can allocate fixtures and dimmers to Groups, which allows you to quickly select a set of fixtures with one button. Groups are described in the next chapter.

Once you have patched fixtures or dimmers, the Patch View screen shows you an overview of what is patched where and lets you edit the patch. See section 4.2.1 on page 94.

4.1.2 PATCHING DIMMERS

Each fixture button can control single or multiple dimmer channels. You allocate a button using the Patch menu (described below) or the Patch View window (see section 4.2.1).

- 1> Press <Patch>, then [Dimmers].
- 2> [DMX Line=] shows you which of the DMX output lines you are patching onto. Enter a new number to change the line. [Address =] shows the DMX address about to be patched. You can change this by typing in the new address on the numeric keypad and pressing <Enter>.

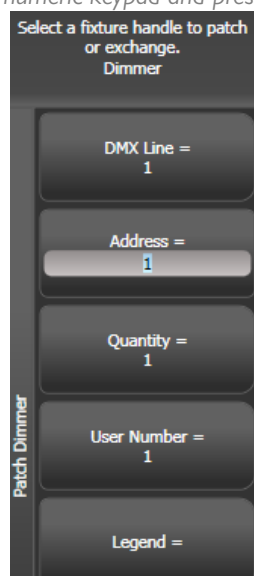

- 3> To patch a single dimmer, press a Fixture touch button, a Macro/Executor button or the blue Select button of a fader handle. To patch a sequence of dimmers each to its own button, press [Quantity] and set the number of dimmers then press the first select button. Alternatively, run your finger or draw a selection box round the touch buttons, or for physical buttons hold down the first button in the range and press the last button in the range. The range of dimmers will be patched to sequential DMX addresses.
 - 4> A fixture button turns dark blue and shows fixture details when it is patched. If you patch to a fader handle the select button will light up dimly.
 - 5> Repeat from step 2 for other dimmers.
- When setting the DMX address using [Address=], you can set the DMX line (universe) as well by entering {line}.{DMX}, for example 2.56 will set DMX address 56 on DMX line 2.
 - To see how DMX channels are patched, press <View/Open> then Patch to show the Patch View window.
 - [User Number = xx] allows you to set a user-defined number for each dimmer or fixture patched, to help you identify them later. You can also edit the User Number from the Repatch Fixture menu.
 - You can patch multiple dimmer channels to a single handle. This can be useful if, for example, you want to control all the lights for one area together. To do this, just press the same Fixture Select button again when patching the new dimmer channel. You can tell the dimmer channel has patched OK because the DMX address will increase by 1.
 - If you need to remove a dimmer from multiple dimmers on a single handle without losing programming, make a copy of the handle then repatch the copy to the individual dimmer address.

4.1.3 PATCHING MOVING LIGHT FIXTURES

Moving light fixtures are more complicated to patch than dimmers because they have more attributes to control, such as pan, tilt and colour, whereas a dimmer channel just has intensity.

Avolites consoles use a “personality” system to control fixtures. This means you don’t have to know how each fixture works, you just tell Titan what you want to do and it will send the right control commands. The console has built-in personalities for most types of fixture, which tell it what attributes are available and how to control them. If the console does not have the personality for your fixture, you can download further personalities from the Avolites website, create your own using the Personality Builder application installed on the console, or Avolites can create one for you. See section 17 on page 341 for details of how to find personalities.

You can patch either using the Patch menu (described below) or the Patch View window (see section 4.2.1).

- 1> Press <Patch>.
- 2> Press [Fixtures].



- 3> Select the correct fixture manufacturer from the softkeys ([Previous] and [Next] page through the list of manufacturers). Or use Quick Search and type the first few letters of the manufacturer's name on the keyboard to find the one you want.
- 4> Select correct fixture from the softkeys (F and G show other pages). You can use Quick Search here as well.
- 5> Select the correct fixture operating mode from the softkeys.
- 6> [Address =] shows the first free DMX address. Type the new address on the numeric keypad if you want a different one. [DMX line=xx] lets you patch to a different DMX line, or you can enter the address as [line].[address], e.g. 2.45 would set address 45 on line 2.

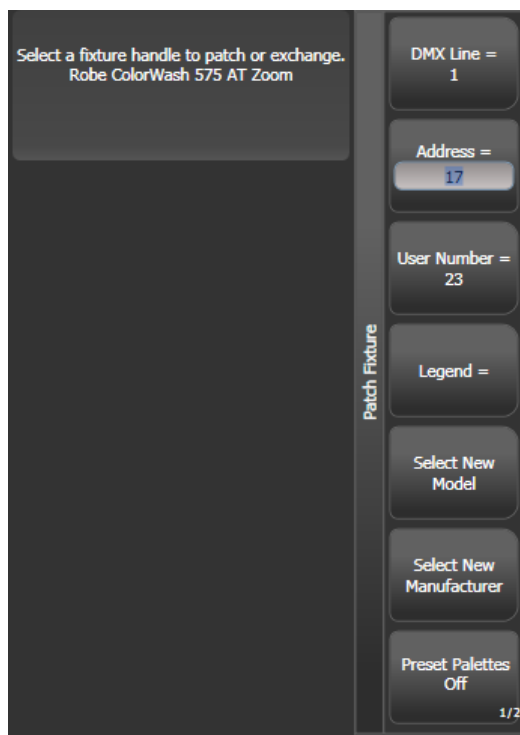

- 7> Patch the fixture by pressing a Fixture touch button, a Macro/Executor button or the blue Select button of a fader handle (not the main playback faders).
 - 8> A fixture touch button turns dark blue and shows fixture details when it is patched. If you patch to a fader handle the select button will light up dimly.
 - 9> Repeat from 7 to patch more of the same fixture type. The DMX address automatically updates so you can just keep patching by pressing Select buttons.
- To patch multiples of the same fixture, use the [Quantity] option. Or you can run your finger or draw a selection box round the touch buttons, or for physical buttons hold down the first button in the range and press the last button in the range. The fixtures will be patched to sequential blocks of DMX addresses.
 - [Options], [Offset] allows you to leave gaps in the DMX channels between fixtures when patching multiple fixtures, which is useful if you are planning a show which may involve exchanging fixtures. The Offset number is the size of the block which will be allocated to the fixture, for example if you want to allow 32 channels for each fixture you would set Offset to 32.
 - You cannot patch more than one fixture onto a handle. If the handle is already used, the patch will fail.
 - If you are patching a fixture which uses a separate dimmer channel, such as a VL5, you can patch the dimmer channel onto the same handle as the moving light part of the fixture so you can control it all together. This is called a Pending Dimmer (in the Patch View window this is indicated with a flash symbol behind the user number).
 - [Options], [Preset Palettes] sets whether the console will create default colour, gobo and position palettes for the new fixture. These are created in the Position, Colour and Beam workspace windows.. This option is turned off by default but can give you a useful starting point.

- [Options], [AutoGroups] sets whether the console will automatically create groups from the fixtures you patch. If Enabled, a group is created for all fixtures of the same type, and another if you patch a quantity of fixtures.
- To show the DMX address for fixtures, press <View/Open> then <Patch>. To show patch details for a single fixture press <View/Open> then the fixture select button. On touch buttons the DMX address is displayed on the top right of the button in the format {DMX line}.{Address} (this display can be disabled using the context menu).
- If a patch goes over the capacity of a DMX line, the console will patch at the beginning of the next line. For example if you try to patch a moving head fixture at channel 1.510, it will actually be patched at 2.1.
- The console will show a picture of the fixture you select in the prompt area to help you check you have got the right one (if provided in the fixture personality; some fixtures do not include this information)

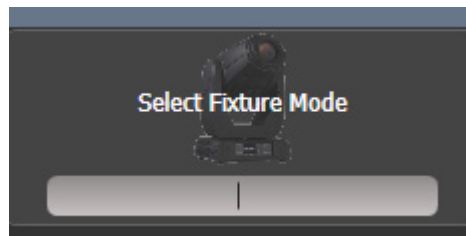

4.1.4 CAPTURE VISUALISER AUTO PATCH

If you want to use Capture Visualiser, start it by pressing <View/Open> then [Open Workspace Window] then [Visualiser]. Some consoles also have a dedicated <Visualiser> button. Capture will open in a workspace window with an automatic representation of your patch.

You will see the fixtures you have patched laid out on screen in handle number order. You can then use the Visualiser controls to reposition the fixtures if you wish – see chapter 11.

- You can turn off Auto Patch in the Capture Visualiser Settings window (Stage tab).
- Fixture modes which will work with Auto Patch show a Capture icon in the button. If the icon is not shown, that fixture mode isn't supported in the integrated Capture.



- If you are using the console linked to the full version of Capture (Nexum or above) on an external computer, then changes to the patch on the console will automatically sync to the Capture show. Also changes you make in Capture will sync back to the console. See section 11.4 for more details.

4.1.5 PATCHING FIXTURES WITH MULTIPLE CELLS (SUB FIXTURES)

Some fixtures have multiple cells of control within a single fixture (for example an RGB LED batten). To avoid having to patch every cell as a single fixture, you can patch the whole fixture as one “super fixture” and each cell will then appear as a “sub fixture”. This is very useful when laying out fixtures for use with the Pixel Mapper as it allows you to move and rotate the fixture as a single fixture, but keep individual control over the cells.

If you access the fixture using the handle it is patched on, all cells of the fixture will be controlled together. To access the sub fixtures independently, use the Attribute Editor window or you can press <Unfold> then the select button of the fixture. In the Fixtures workspace, the current page of fixtures will be replaced by select buttons for each individual fixture cell. If patched on a fader then the cells will start at fader 1. You can also select subfixtures from the numeric keypad. See section 5.1.4 on page 111 for more details of working with fixture cells.

To go back to normal, press <Unfold> then [Exit Unfold].



The Sub fixtures feature has to be defined in the fixture's personality. If sub fixtures does not work on your fixture you may need to obtain the latest fixture personality from Avolites.

4.1.6 PATCHING ACTIVE FIXTURES / MEDIA SERVERS

For Ai media servers please see Section 12 on page 269 for more details of how Synergy allows you to connect to Ai for control of the setup and media playback.

Other media servers which support CITP can be patched using the [Active Fixtures] command on the Patch menu. This allows the console to retrieve thumbnail images of the media clips to display in the Attribute Editor when you are selecting the clip to play.

Once the media server is connected to the network, selecting [Active Fixtures] then [CITP Media Servers] will display a list of the available display layers on the connected server(s). Each layer can then be patched to a fixture button for control.

4.1.7 PATCHING BY RDM

RDM (Remote Device Management) is a system which allows the console to interrogate the lighting rig to find out what's there. It can then patch itself to match the existing DMX addresses. You can also remotely change modes and other settings on the fixture.



The fixtures need to be connected to the console by an RDM-enabled Artnet node, the XLR connectors do not support RDM. Obviously the fixtures must be equipped with RDM for this to work; many fixtures are not. Also if you have DMX buffers or splitters in your rig, they must be RDM enabled or they will block the information being sent back to the console.

Press <View/Open> then <Patch> to open the Patch View window then select the RDM tab. All devices which support RDM will be listed here. Click the [Full Discover] context menu button to rescan the rig for RDM devices.

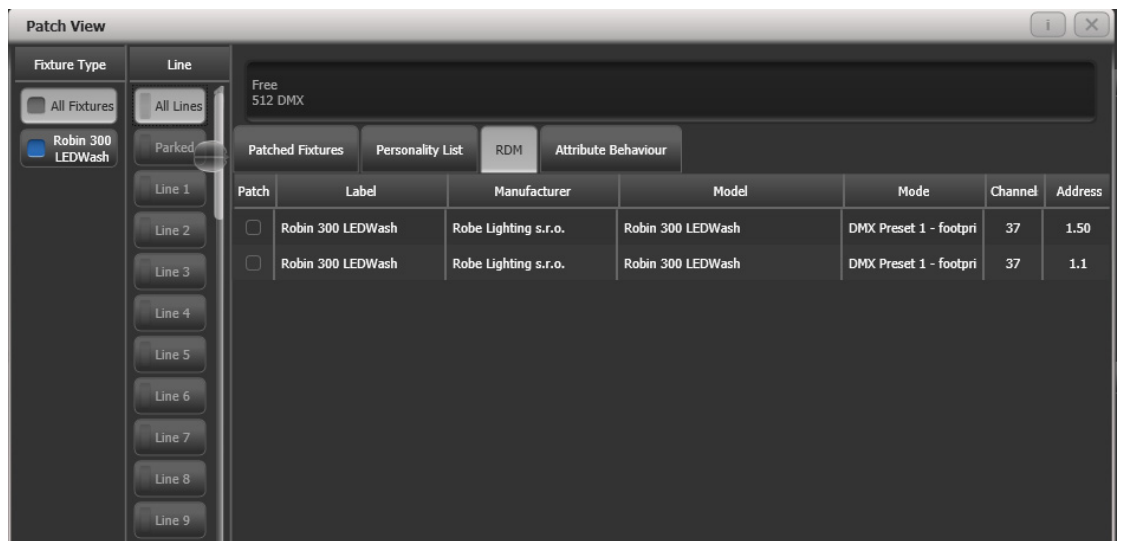

- Select one or more fixtures in the grid and click the Patch context menu button to patch the devices.
- Click on the Mode or Address cells in the grid to change these settings remotely.
- Click on the Identify button (at the right hand end of the screen, you might need to scroll to see it) to turn the fixture on so you can see where it is in the rig.
- Click on the RDM Quick Patch context menu button to automatically patch all RDM devices.

4.1.8 FINDING A LOST FIXTURE

Sometimes a fixture may be rigged with the wrong DMX address set, or connected to the wrong DMX line.

The Find Fixture function allows you to find the start address of the fixture by scrolling a “locate” state through all possible DMX addresses. When the fixture responds with its Locate state, you know its DMX address and might hopefully avoid a trip up the rig to look at it..

- 1> Press <Patch>, [Fixture] and select the type of fixture you are looking for
 - 2> Press [Options], then [Find Fixture] to enable the Find Fixture mode.
 - 3> Turn Wheel B to go through all possible DMX addresses. Wheel A sets DMX lines.
 - 4> When the fixture responds with its Locate state, you have found the correct DMX address.
 - 4> Turn off [Find Fixture] mode and (if not already occupied) patch the fixture. The DMX address/Line will be automatically set to match the Find Fixture settings.
- Wheel C (DMX Slot) jumps through DMX addresses using the fixture channel count (for example if a fixture uses 16 channels, it will jump through in 16’s).

4.2 CHANGING THE PATCH

4.2.1 PATCH VIEW

The Patch View window gives a full overview of how all the fixtures in your show are patched, and allows you to patch, repatch, legend, renumber, invert, pan/tilt swap, freeze, exchange, park and view fixtures. If you need to change the settings of multiple fixtures (for example, changing the DMX address of several fixtures) then it's really easy to do in one operation in the Patch View.

To show the Patch View window press <View/Open> then <Patch>, or use the Open Workspace Windows menu command.

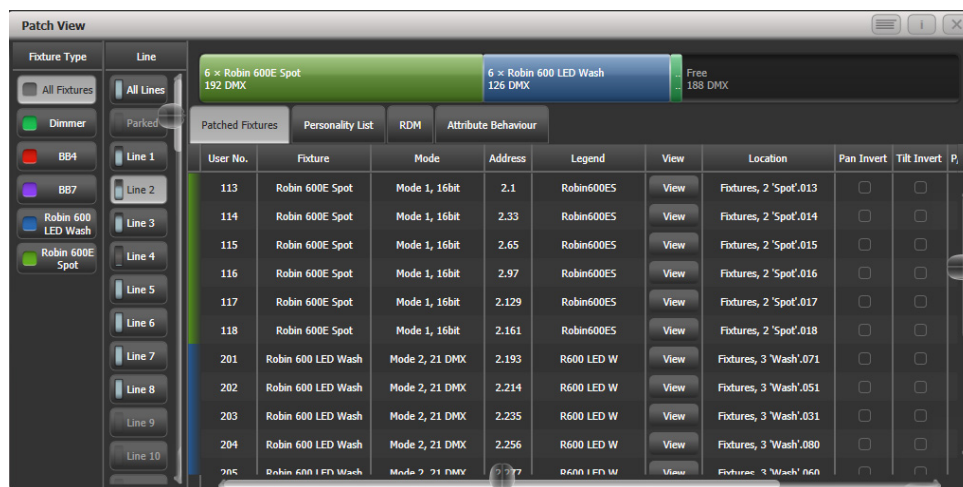

Fixture type: lists the different types of fixture in your show. Each fixture has a unique colour code. Click on these buttons to filter the view so it only shows one fixture type.

Line: lists the available DMX output lines/universes. The blue bargraph in the button shows how much of the line is used by patched fixtures and how much is free. Click a button to show the details of that line in the right hand side of the window.

The **coloured bar** at the top shows how fixtures are patched on the selected output line, using the unique colour code for each type of fixture. Click on a section of the bar to select those fixtures in the grid below.

The **grid area** shows details for each patched fixture on the selected output line. Some parameters are editable by clicking in the grid, then the softkeys allow you to change the parameter.



You can change parameters for multiple fixtures by dragging a selection box over the grid, or hold the Ctrl button on the keyboard and click on the required fixtures. Then edit the parameter on the softkeys, and use the [Set] context button or press <Enter> to update the selected fixtures.

- You can switch off some of the display columns to make the Patch View simpler. Press the [Choose Columns] context menu button and then use the options on the softkeys to turn columns on and off.

- You can add notes to each fixture in the Patch View. Click on the Notes field and enter text using the keyboard.

The tabs across the top allow you to switch the window to Personality List (lists all fixtures available on the console), RDM (allows you to patch devices using RDM) and Attribute Behaviour (allows you to set invert, freeze, curve, and limit. See section 4.4.2 and following sections for Attribute Behaviour).

A context menu option allows you to show or hide parked fixtures. If you show parked fixtures they will appear greyed out in the position they were originally patched.

4.2.2 VIEW DETAILED FIXTURE INFORMATION

In the Patch View window click on the View button for the fixture you wish to view, or press <View/Open> followed by a fixture handle. A Fixture View window will open showing details for that fixture, including the personality and mode used to patch, and the individual DMX channel addresses for each attribute. Attributes can be inverted or frozen by clicking on the checkboxes at the right hand side.

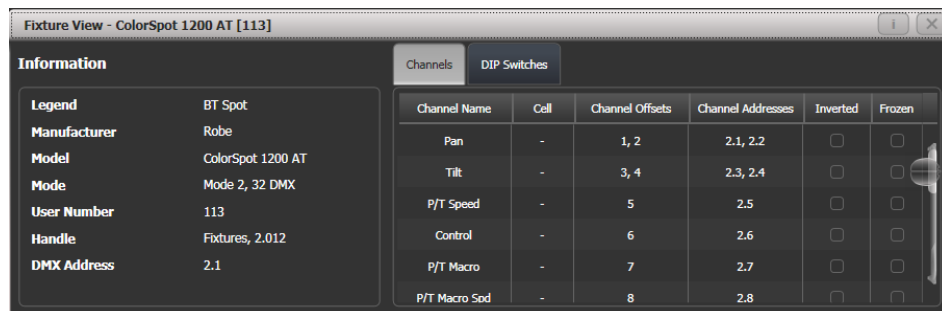

If the fixture address is set using DIP switches, the console can show you how to set the switches by clicking on the DIP Switches tab.

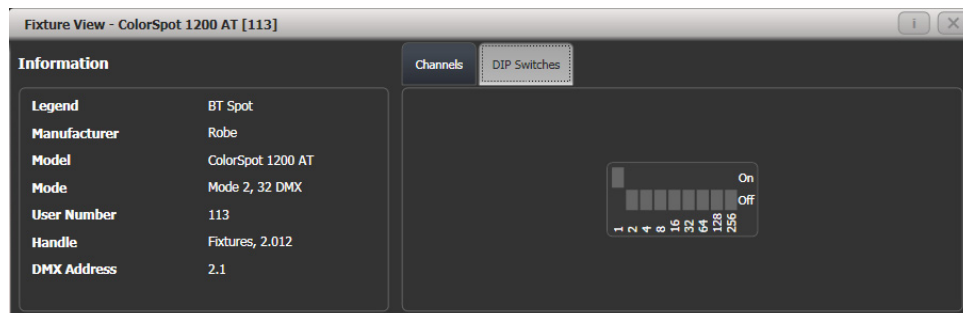

There is also a Personality tab (not shown in the pictures) which shows history information about the personality file for the fixture. This can be useful for checking the version of the personality file.

4.2.3 CHANGING DMX ADDRESSING USING PATCH VIEW

You can easily change the DMX address of one or more fixtures from Patch View. Select the DMX address cells you want to modify – draw a selection box over multiple cells to select more than one.

Mode	Address	Fixture	View
Dimmer	2.319	Blinder	V
Dimmer	2.320	Blinder	V
Dimmer	2.321	Blinder	V
Dimmer	2.322	Blinder	V
Dimmer	2.323	Blinder	V
Dimmer	2.324	Blinder	V
Dimmer	4.40	S4	V

Type the new address for the first fixture in the selection and press <Enter> (using the format Universe . Address – if you miss out the universe part it will stay unchanged).

All fixtures will be renumbered keeping the addressing offset between the fixtures the same (in other words if each fixture takes 20 channels, the addresses will be set with an offset of 20 channels between each fixture).

The [Swap Fixture Addresses] softkey lets you swap the addressing between two groups of fixtures. This operates in two modes, [One For One] or [Retain Layout], which you can select by softkey after pressing [Swap Fixture Addresses].

Select one group, then press [Swap Fixture Addresses] and select the target group. In One for One mode the target must be the same quantity of fixtures or the console will display an error. In Retain Layout mode the console will attempt to add or remove fixtures to get the same quantity – if this conflicts with other fixtures it will give you the options to [Park Conflicting] or [Cancel].

4.2.4 CHANGING DMX ADDRESS USING PATCH MENU

As well as using the Patch View screen, you can use the Patch menu to re-patch a fixture to a different DMX address or a different DMX output line. All programming is kept.

- 1> Press <Patch> (if you're not already in Patch mode).
- 2> Press [Repatch Fixtures].
- 3> Press the Select button of the fixture you want to change.
- 4> To change DMX press [Address], type the new address and press enter. If this address is already in use, a warning icon will be shown.

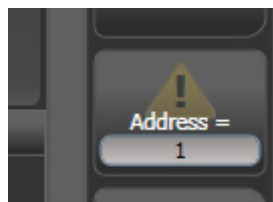

- 5> To change the DMX output line, press [DMX Line=x] and enter a new output line number.
- 6> Press <Enter> or [Repatch] to confirm the change.
- 7> Repeat from step 3 if you want to change other fixtures.

- You can “Park” the fixture using [Park]. This removes the fixture from the DMX output map, but all programming is retained. The original DMX line and address is remembered and you can restore it using the [Unpark] option.
- If the new DMX address already has another fixture or dimmer patched on it, the console will warn you (unless this is disabled in User Options, see section 16.1.6 on page 320). You can either press [Select another DMX address] to abort the change or [Park Conflicting Fixtures]. All programming for the parked fixture is preserved, but you need to repatch it to a free DMX address using the above procedure before you can use it again. If you press [Always Park Conflicting Fixtures] the console will park this and any future conflicting fixtures without warning you (you can change this option back in the User Settings).

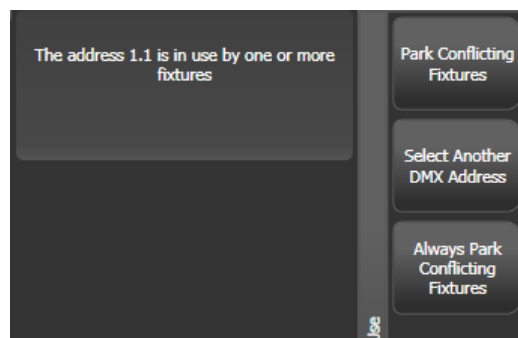

4.2.5 SETTING LEGENDS

You can set a legend for each fixture or dimmer you’ve patched which is displayed in the touch button. This can be really useful to help you identify the fixture.

- 1> At the main menu press [Set Legend].
 - 2> Press the Select button for the fixture you want to legend.
 - 3> Type the legend on the keyboard.
 - 4> Press <Enter> when you have finished.
- You can also choose to have a picture legend using the softkey options.
 - You can set the same legend for multiple fixtures by selecting a group of fixtures after pressing [Set Legend].
 - You can change the User Number for the fixture using the [User Number] softkey on the [Set Legend] menu. User Numbers are used when selecting fixtures from the keypad theatre-style.
 - You can automatically allocate User Numbers for multiple fixtures by selecting a group of fixtures, then setting [User Number]. The first fixture will have the User Number you entered, and the other selected fixtures will be given a number increasing by 1 for each fixture.
 - You can set a legend for the current page of fixtures using the [Set Legend] function from the main Program menu. The legend is shown on the touch button for the page and on the HUD.

4.2.6 FIXTURE BUTTON HALO

You can configure fixture buttons to have a “halo” colour which helps you to find them quickly. Halo colours can be set manually for each fixture (the default setting), or automatically by fixture type using the same fixture colours used in the patch window..

To set a manual halo colour, click [Set Legend], click the fixture button (or select multiple buttons) then select the [Halo] option. A colour picker will open to let you set the colour, or pressing [System Colours] will give you colour options on the softkeys. A [Remove Halo] softkey lets you remove the colour.

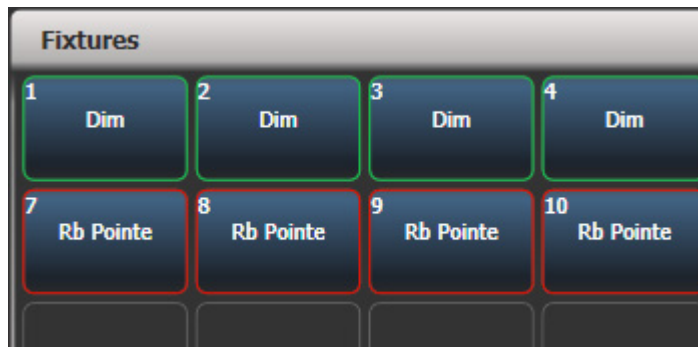

To enable automatic halo colours, hold <Avo> and select [User Settings], then [Handles], then set Fixture Halos to [Auto]. Fixture buttons will then be coloured to match the automatic fixture colours used in the Patch window.

Halo colours are also shown in the Intensity View and Show Library workspace. In list views such as DMX, Channel Grid, Cue View and Palette view the halo colours are shown as a bar to the left of the list – this uses the user halo colour if one is set, otherwise the automatic colour is used. The User Setting does not affect this display.

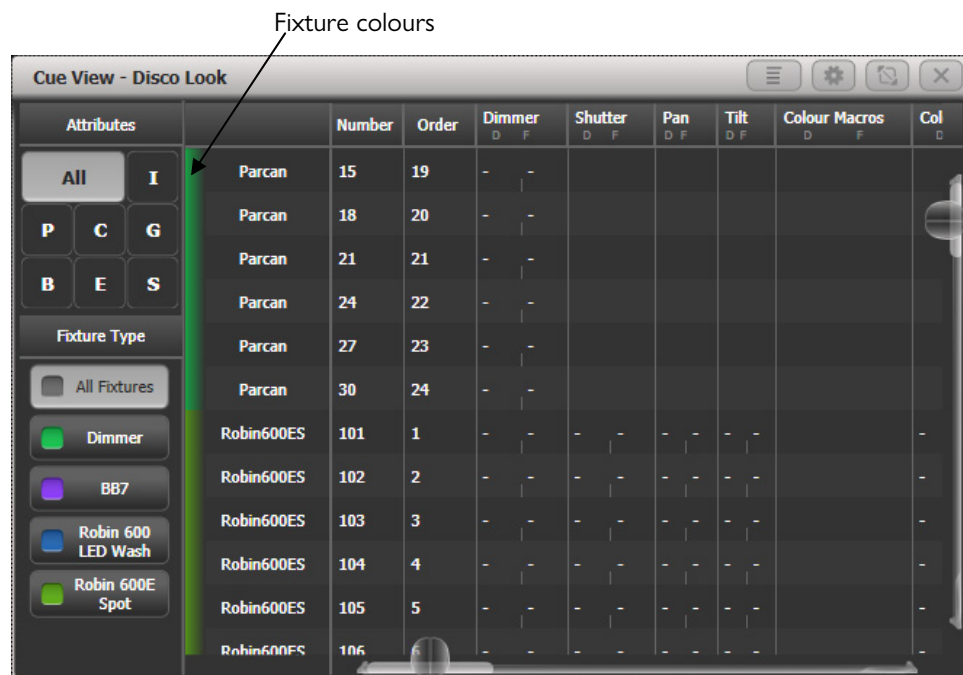

4.2.7 DMX VIEW WINDOW

When you're having problems getting fixtures to work it can be useful to see the actual DMX output values coming from the console. Press <View/Open>, then [Open Workspace Window], then select [DMX].



Line	Index	Line	Address	Control	Output
Line 1	1	1	1	Dimmer	227
Line 2	2	1	2	Dimmer	0
Line 3	3	1	3	Dimmer	196
Line 4	4	1	4	Dimmer	0
Line 5	5	1	5	Dimmer	0
Line 6	6	1	6	Dimmer	0
Line 7	7	1	7	Dimmer	30
Line 8	8	1	8	Dimmer	0
Line 9	9	1	9	Dimmer	0
Line 10	10	1	10	Dimmer	0
Line 11	11	1	11	Dimmer	0
Line 12	12	1	12	Dimmer	0
Line 13	13	1	13	Dimmer	0
Line 14	14	1	14	Dimmer	0
Line 15	15	1	15	Dimmer	0
Line 16	16	1	16	Dimmer	0

The buttons on the left let you select the different output lines from the console. Scrolling the window to the right shows more information about each DMX channel.

4.2.8 FIXTURE EXCHANGE

The Fixture Exchange function enables you to repatch fixtures in your show using alternative fixtures, retaining important elements such as cue times, shapes and legends. This is very useful for touring shows and venues with a high turnover of events.

Fixture Exchange works best if you use Palettes to create your cues. This allows you to adjust for position differences and so on by reprogramming a few position palettes, rather than having to reprogram every cue. Cues recorded with absolute values will need to be re-recorded, preferably using palettes.

The pan, tilt and dimmer will always be preserved from one fixture type to the next. For other attributes, the console will attempt to match the functions between the fixtures, but you can change the details of this using the Exchange Mapping function (see next section). All programmed items including palettes will be preserved, so the programming can be easily adjusted by updating your palettes as normal.

Fixture exchange also gives you a powerful way to re-use an existing show with new lights, so you can give yourself a programming head start when faced with a new fixture.

- It's a good idea to save your show before performing major changes such as fixture exchange. Should you change your mind or have problems, you will easily be able to return your show to its previous state.

- 1> Enter patch mode by pressing <Patch>.
- 2> Select the new fixture type you wish to use.
- 3> Touch the select button of the fixture which is to be exchanged.
- 4> The console will warn you that the fixture is in use. Press the [Exchange Fixture] option.
- 5> Repeat from step 3 to exchange other fixtures with the same type of new fixture.



After exchanging fixtures you need to update the palettes which used those fixtures. If you have trouble switching values off in a palette, set new values for all the attributes in the attribute group and re-record the palette. You should then be able to switch off an attribute group as required.

4.2.9 EXCHANGE MAPPING

When you exchange fixtures the console will attempt to map the functions on the new fixture to the same functions on the old fixture so that your show does not look any different with the changed fixtures.

However, this may not always work out quite right, so using Exchange Mapping you can manually map functions between the fixtures. For example this allows you to map the old gobos to similar new gobos even if they are not in the same wheel position, and to ensure that rotation speeds work the same.

Any changes made will apply immediately to the show. Mappings are remembered and will be used whenever you exchange the same fixtures in the future (though you can restore to factory mappings at any time should you need to using the [Clear All Mappings] softkey).

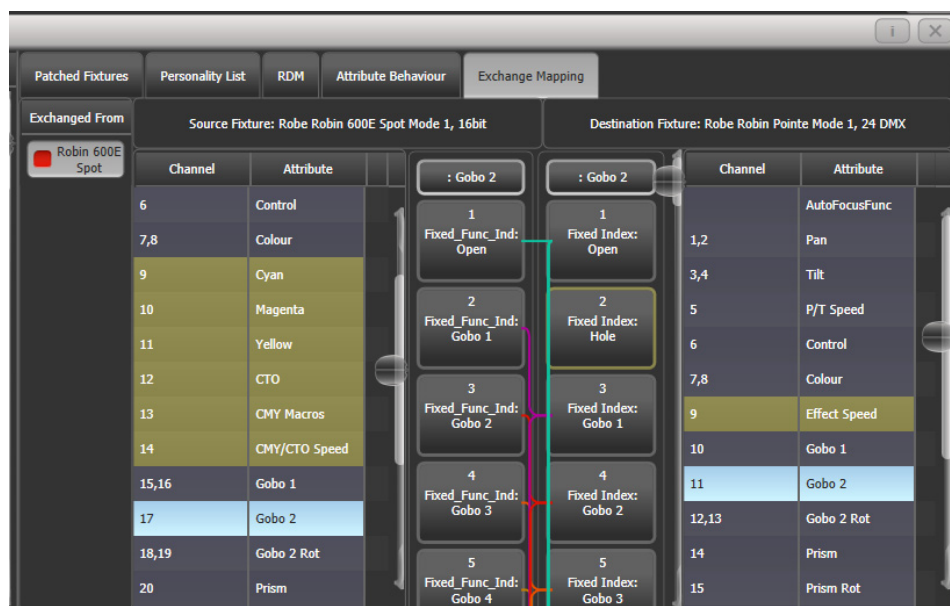

To set up mapping:

- 1> Press <View/Open> then Patch to show the Patch View screen.
- 2> Select the Exchange Mapping tab.
- 3> In the leftmost column, click the fixture type of the new fixture which you have changed to.
- 4> The view shows the old fixture on the left and the new fixture on the right with attributes listed for both fixture types. You can sort the list either alphabetically or in DMX channel order using the [Sort] context menu option.
- 5> Select an attribute to show the mapping. The mapped attribute on both fixtures will highlight in light blue. Brown controls are not mapped. The centre of the view shows the individual functions of the selected attribute, and coloured lines show how these map between the fixtures.
- 6> To map a function, click on a source function then a destination function. Any previous mapping will be removed. You can map multiple source functions to a single destination function.
- 7> To unmap a function, double click the source function. If there are multiple sources mapped, double click the destination function.
- 8> To move a mapping, click the existing destination, then click the new destination.

- Where a fixture has been exchanged from more than one source fixture you can switch between them by selecting the relevant source fixture under the 'exchanged from' column.
- When you change the mapping, the 'Unsaved Changes' options will pop up at the bottom of the screen. Here you can store the new mappings by pressing Apply, forget the changes by pressing Cancel or restore all mappings to Avolites factory default by pressing Reset. All these actions have to be confirmed by pressing the [Confirm] softkey.

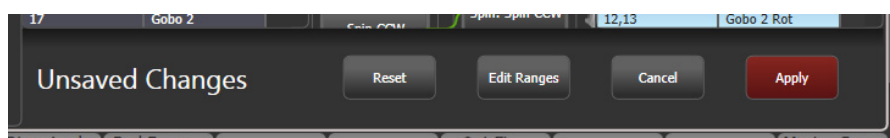

Range mapping

If the destination function has a range (for example 0-100%) you can adjust the range to which the source function is mapped.

Where multiple source functions are mapped to a single destination function with a range, separate destination buttons are shown allowing you to set a different destination range for each source function.

To set the range, first select a destination function, then click the Edit Ranges option at the bottom of the window. Then select the function whose range you wish to change. (Note that it is only possible to adjust the range of a mapped function. Any functions that are not mapped or are not ranges will grey out). You can then adjust the maximum

and minimum values for the range either by wheel, by touching the wheel view on touch consoles or by selecting the relevant softkey and entering the value.

Once complete, click Apply then [Confirm] to commit the changes or Cancel then [Confirm] to forget.

4.2.10 UPDATING PATCHED PERSONALITIES

This option allows you to update the personality for a fixture used in your show. Normally a copy of each fixture personality in the show is saved in the showfile, so updating the personality library on the console does not update fixtures which are already patched.

- It's a good idea to save your show before using Update Personalities, then you will be able to undo any changes if you change your mind or have problems.

- 1> Enter patch mode by pressing Patch.
- 2> Press [Edit Fixtures]
- 3> Press [Update Personality] to update an individual fixture type, or [Update All] to update all patched fixtures to the most recent version in the library.
- 4> If updating individual fixtures, the console shows you a list of personalities used in the show which can be updated.
- 5> If updating individual fixtures, press the personality you want to update.

- The new personality is loaded from the Titan/Personalities folder.

4.3 COPYING, MOVING AND DELETING FIXTURES

4.3.1 COPYING OR MOVING A PATCHED FIXTURE

Using the <Copy> button you can make a copy of an existing fixture or move it to a new button. You cannot link fixture buttons. You can copy or move multiple fixtures in one operation.

Fixture copying is very useful if you need an additional fixture of a type you've already patched and programmed because the new copy will come complete with all the cues and palettes of the original fixture you've copied. The copied fixture will be "Parked" (have no DMX channel allocated) so you will need to set an address before you can use it (see section 4.2.1 above)

Move is useful for tidying up the console.

- 1> Press the <Copy> button.
- 2> Select [Copy] or [Move]. Pressing the <Copy> button again will also toggle through these options.
- 3> Press the Select button of the fixture you want to copy/move. You can select multiple fixtures – use the <Thro> and <And> buttons to add more fixtures to the selection.
- 4> Press the empty Select button where you want it to go.

- The <Menu Latch> button latches the Copy/Move/Link menu, so you can keep copying or moving things without having to keep pressing the Copy/Move/Link button. Press again to unlatch.
- The [Retain Layout] or [Bunch Up] option is used when copying a group of fixtures with empty handles in the group – you can either keep the empty handles, or bunch up the used handles together. There is also a [Bunch Up With Offset] option which allows you to leave a gap in the DMX channels, if you are running a show where you need to exchange fixtures to ones which use more DMX channels.
- When in Copy mode, option [Copy Legends] can be changed to [Don't copy legends] so that the copied fixtures are given default legends.
- When in Move mode, [Swap Items if Required] will attempt to reposition any existing handles which are in the way of the move. This is useful when rearranging buttons on a page which is nearly full.

4.3.2 DELETING A PATCHED FIXTURE

You can delete a fixture or dimmer from a button if you patched it accidentally or if you change your rig and want to use the button for something else.



All programming for the fixture is also deleted. You cannot undo deletion of a fixture or get the programming back by repatching a fixture to the same handle. If you might need the fixtures again later, move them to an unused fixture page.

- 1> Enter Patch mode by pressing the <Patch> button.
 - 2> Press the <Delete> button.
 - 3> Press the Select button of the fixture you want to delete.
 - 4> The button will light up red and the console asks for confirmation. Press the Select button again to confirm.
- You can delete a range of fixtures in one operation.

4.4 FIXTURE PERSONALITY OPTIONS

All of the options below can also be set from the Patch View window.

4.4.1 SWAP PAN AND TILT

This allows you to make the pan channel control tilt and the tilt control pan. This can be useful for fixtures rigged in strange orientations.

- 1> Press <Patch>.
- 2> Press [Edit Fixtures].
- 3> Press [Swap Pan and Tilt].
- 4> Select the fixtures to be pan-tilt swapped. Press [Pan and Tilt ...] to select either [Swapped] or [Normal] for the selected fixtures.
- 5> Press <Exit> when finished.

4.4.2 INVERT ATTRIBUTES

This option inverts individual attributes of fixtures. Useful if you have a fixture which pans right when the rest pan left, saving a trip up the rig to set fixture options, but you can invert any attribute.

- 1> Press <Patch>.
- 2> Press [Edit Fixtures].
- 3> Press [Invert Attribute].
- 4> Select fixture(s) to be changed.
- 5> Select the attribute to invert from the softkeys. The display shows [Inverted] when the attribute is inverted.
- 6> Press <Exit> to finish.

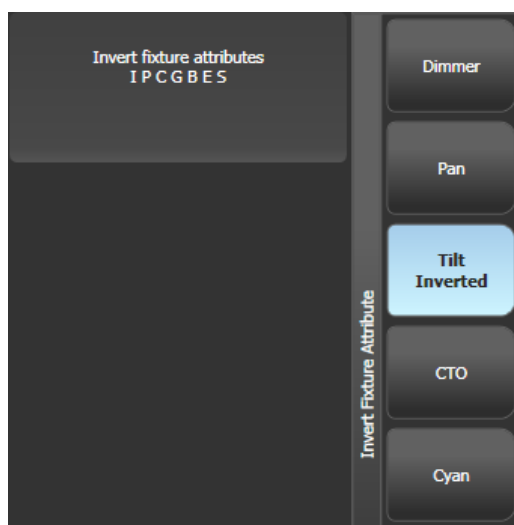

- You can change the invert on multiple fixtures by selecting more than one, but the “Inverted” display will not show if there is a mixture of inverted and non-inverted fixtures in the selection.
- Some attributes cannot be inverted.
- Invert can also be set from the Attribute Behaviour tab of the Patch View window.

4.4.3 ATTRIBUTE LIMITS

You can set upper and lower limits for any attribute. This can be useful for example to limit the pan/tilt movement of a fixture, or if a fixture has a combined dimmer/strobe function and you only want the dimmer part of the operation.

Attribute limits are set either from the Edit Fixtures menu or using the Attribute Behaviour tab of the Patch View window.

- 1> Press <Patch>.
- 2> Press [Edit Fixtures].
- 3> Press [Set Limits].
- 4> Select the fixtures to be set.

- 5> Use the softkeys to select which attributes are to be set, then select upper or lower limit.
- 6> Input a percentage value for the limit value, or press [Set To Current Value]. To remove a limit press [Remove Limit].
- 7> Press <Exit> when finished.

From the Attribute Behaviour tab, use the context buttons to set Attribute Limits.

It is still possible to put values into the programmer outside the limits. A “limited” watermark will appear on the wheel view behind an attribute when it is being limited.

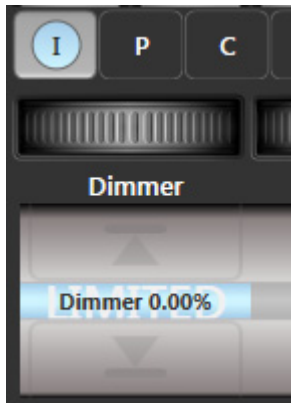

4.4.4 FIXTURE OFFSET

You can set an offset to any attribute of any fixture. The normal use for this is to correct pan/tilt positions when fixtures are rigged in a different orientation to how they were programmed. The offset is applied to channels just before final output.

There are 4 ways to set an offset:

- Select fixture, <Locate>, then adjust attributes to the desired locate value. Then press <Record>, <Locate>, [Update Offset]. This does not change the actual locate value but sets the difference between the locate position and your set position as the offset. This is an easy visual way to set the offset.
- You can also set offsets using palettes. Select fixture, apply palette, adjust fixture to desired values then press <Record>, <Palette>, [Update Offset]. Again this does not change the palette, but sets the difference between the palette and the position you changed it to as the offset value.
- In the Patch View window, in the Patched Fixtures list there are cells for Pan or Tilt offset
- In the Patch View window, in the Attribute Behaviour tab you can select [Offset] from the context menu buttons. This lets you view or adjust offsets set by the first two methods.

4.4.5 FIXTURE / ATTRIBUTE CURVES

Curves set how an attribute behaves over the full range of values. They are most often used for dimmer attributes to set the way the dimmer level follows a slider, but can be applied to any attribute.

Curves are set either from the Edit Fixtures menu or using the context buttons on the Attribute Behaviour tab of the Patch View window.

- 1> Press <Patch>, [Edit Fixtures].
- 2> Press [Set Curve].
- 3> Select the fixtures to be set.
- 4> Use the softkeys to select which attributes are to be set.
- 5> Use the softkeys to select the type of curve required. The normal setting is Linear.
- 6> Press <Exit> when finished.

See section 16.6 on page 334 for details of the different curves available.

4.4.6 FREEZE FIXTURES OR ATTRIBUTES

This option allows you to freeze individual attributes of a fixture, or to freeze the whole fixture. Attributes or fixtures which are frozen are not affected by playbacks or by the programmer.

- 1> Press <Patch>, [Edit Fixtures].
- 2> Press [Freeze Fixture or Attribute].
- 3> Select the fixtures to be frozen/unfrozen.
- 4> Use the softkeys to select which attributes are frozen, or to freeze the whole fixture. Frozen attributes are indicated on the softkey.
- 5> Press <Exit> when finished.

- Freeze can also be set from the Attribute Behaviour tab of the Patch View window.
- A “Frozen” watermark is shown on the wheel display when an attribute is frozen.

4.4.7 EDITING THE PERSONALITY

Sometimes you may want to modify the way a fixture behaves, or you may find a fixture personality contains errors and needs editing. You can edit personalities directly on the console.

- 1> Press <Patch>, [Edit Fixtures], .
- 2> Press [Edit Personality].
- 3> The softkeys show a list of all fixture types patched in your show. Select the fixture type to be edited.
- 4> Personality Builder will open allowing you to edit the personality.
- 5> When you save changes, your show will be updated with the edited personality. Your changes are also saved to the fixture library on the console.

- Edited personalities will be saved in the User/Custom personality folder at D:\Personalities (if using Titan Mobile, Titan Go or a simulator, the folder is at \Documents\Titan\Personalities). Personalities in this folder are searched and loaded before those in the library and are not overwritten when a new fixture library is installed.
- A separate user guide for Personality Builder is available from the Avolites website.



If you find a problem in a fixture personality provided by Avolites, please let us know using the bug report form in the Personality section of the website..

5. CONTROLLING DIMMERS AND FIXTURES

When you are programming a show, and sometimes when you are running a show, you need to manually control the fixtures and dimmers to set the intensity, position, colour, etc. To do this you first select the fixtures you want to change using the select buttons, then you set the attributes of those fixtures using the Wheels and Attribute buttons.

You can also set fade/timing information for each attribute of each fixture which is treated as an additional attribute of the fixture.

5.1 USING THE SELECT BUTTONS AND WHEELS

5.1.1 SELECTING FIXTURES AND DIMMERS FOR CONTROL

To select the fixtures or dimmer channels that you want to control, you use the Fixture Select buttons to select the fixtures into the Editor. You can select fixtures or dimmers individually, or several at once. You can also use Groups to select multiple fixtures, see section 5.3.1 on page 134.

If the fixture is patched on a fader handle, press the blue button to select the fixture.



- 1> Press the Select buttons for the fixtures you want. Touch buttons will light up pale blue when selected, physical buttons will light brightly.
- 2> To select a range of fixtures, slide your finger across the touch buttons to draw a selection box. For fixtures patched on faders, hold down the Select button for the first fixture then press the Select button for the last fixture.

Here are some other useful things to know:

- Press <Locate> to light up the selected fixtures in open white and move them to a central position. See the next section for more Locate options.
- You can deselect a fixture by pressing the select button again.
- In the top bar of the screen, the console will show you which fixtures are currently selected.
- Press <Clear> (right of numeric keys) to deselect all fixtures and remove all changes from the programmer. See the next section for more Clear options.

- Once you have changed any attribute, pressing a Select button will deselect all fixtures and start the selection process again. All previously selected fixtures (since you last pressed <Clear>) stay in the programmer. Once a fixture has been edited, Fixture buttons show a darker blue. The picture above shows the first two fixtures selected, with the second three in the programmer and the others unselected.
- You can select fixtures on another page by touching one of the page buttons to the left of the fixture buttons, if you have 'Pages' set to Show (using the context button). Otherwise you can use the scroll slider to show more buttons. On fader handles, Page buttons are provided to change pages – on the Pearl Expert these are above the numeric keypad, on other consoles they are next to the faders.
- Using Key Profiles (see section 16.3.1 on page 322) you can set the fixture touch button to latch mode so that it turns the fixture's dimmer channel on (like putting a preset fader to full).

5.1.2 SETTING FIXTURES TO A START POSITION (LOCATE)

The <Locate> button is used to put the fixture into a known position with light coming out, so that you can start programming it.

A quick press of the button will move all selected fixtures to a central position and reset all the attributes so that you get a white light. However you sometimes might not want to move the fixture, or may want to keep some other attributes unchanged. By holding down the <Locate> button rather than a quick press, you get some more options

- You can mask off some of the Locate settings (such as only turning the fixture on, but not changing its position or colour) by holding down <Locate> and pressing [Set Mask to Exclude All]. Then (still holding <Locate>) turn on the Attributes you want to change using the Attribute buttons. Only the lit attributes will be changed by Locate. Pressing the <Options>/<Attribute Options> button will clear the mask.
- Option [Auto Reset Mask] sets the mask to be automatically reset to include everything each time Locate is pressed, or you can toggle the option to [Remember Mask] which will keep the mask setting you used last time.
- Option [Clear/Don't Clear Located Attributes] sets whether the attributes changed by the Locate function will be saved into any cues you store. If the option is set to "Clear" then the Located attributes will not be stored in the Programmer unless you modify them using the wheels. This is useful if for example you want to program a cue which sets the position of fixtures, but does not turn them on. The <Locate> button will light up the fixtures for programming, but the lit state will not be stored in any cues you save.



To quickly locate without changing pan/tilt, hold <Locate> and press the Pan/Tilt (or Position) button, then release <Locate>.

To quickly locate pan/tilt only, hold <Locate>, press <Options> (<Attribute Options> on some consoles), then press <Position> (<Pan/Tilt> on some consoles), then release <Locate>.

Changing the locate state

You can change the default locate state of each fixture in a show by recording a new Locate State. This can be shared (you set the values for one fixture, and then it applies to all fixtures of the same type) or individual (you can set different values for each individual fixture). To store, set up the desired locate state on the fixture(s) you want to change, then press <Record>, then <Locate>. Select [Shared] or [Individual] from the softkeys. Press <Record> or <Locate> a second time to confirm.

5.1.3 CLEARING SELECTION

The <Clear> button (on the right of the numeric keypad) is used to remove all changes from the Programmer and deselect all fixtures. A quick press of the <Clear> button just clears everything, however if you hold down the <Clear> button, then more options are available.

- You can mask which attributes are to be cleared (for example, leaving the pan/tilt in the programmer but clearing everything else) by holding down <Clear> and pressing [Set Mask to Clear Nothing]. Then (still holding <Clear>) turn on the Attributes you want to change using the Attribute Bank buttons down the right hand side, or press [Set Mask] and use the softkeys. Only the lit attributes will be cleared. Pressing the <Options>/<Attribute Options> button will clear the mask. The Time mask option allows you to clear or retain the fade/delay times in the programmer for all attributes (clearing individual attributes will also clear times for that attribute, for example setting a P mask will clear position times).
- Hold <Clear> and press <All> to deselect all fixtures, but leave the changes in the programmer.
- [Clear Options] opens a submenu showing some further options (described below).
- [Clear All Fixtures/Selected Fixtures] sets whether all fixtures will be cleared from the programmer, or if only currently selected fixtures will be cleared. This is useful if you want to clear specific fixtures.
- [Individual Attributes] allows you to clear individual attributes from the Programmer. When you press the softkey, you are given a list of attributes in the Programmer – press the appropriate softkey to clear that attribute.
- [Clear All Programmers] will clear all programmers that are currently active on the console, including Multi-user programmers from other users, and the Titan Remote programmer.

The options in the “Clear Options” submenu are:

- [Auto Reset Mask] sets the mask to be automatically reset to clear everything each time Clear is pressed, or you can toggle the option to [Remember Mask] which will keep the mask setting you used last time.
- [Leave/Zero Preset Fader Levels] is used to set whether latched fixtures are cleared (the fixture key profile can be set to “Latch” mode, which turns on the fixture dimmer channel when the fixture button is touched. See section 16.3.1 on page 322.)
- [Freeze current values] sets what happens to LTP (non-intensity) channels you have modified. If set to [Freeze Current Values] the channels remain as you set

them. If set to [Release To Playback Values] the channels will go back to how they are set in the current playback. For example: you have an active playback making some lights green, then you select the lights and change them to red. If you press Clear with this option set to [Freeze] then the lights remain red. If the option is [Release] the lights will go back to green.

- [Clear/Maintain Cue Times] - determines whether or not to clear the cue time information from the programmer (this will not affect fixture attribute times in the programmer).

You can use the Channel Grid window to selectively view and remove attributes from fixtures. See section 5.2.1 on page 131.



If you type a number then press <Clear>, HTP values in the programmer will fade out over that time, for example 5 <Clear> would fade over 5 seconds. This can be very useful if you are trying to be subtle when making changes during a show.

5.1.4 FIXTURES WITH MULTIPLE CELLS/SUBFIXTURES

If a fixture has multiple cells of control (for example an RGB LED batten) and its personality supports it, you can select and control the fixture either as a whole or as independent cells. This is particularly useful when using Shapes or the Pixel Mapper.

If you select the fixture using the handle it is patched on, all cells of the fixture will be controlled together.

You can use the buttons which appear at the top of the attribute editor window to select the main fixture, or individual cells for control (use the [Open Workspace Window] softkey to open the Attribute Editor window).

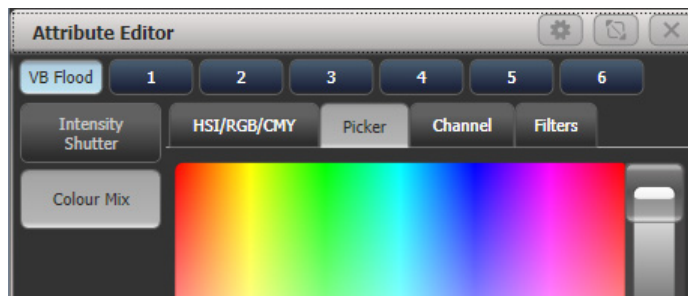

You can also use <Unfold> to expand the cells onto individual select buttons. In the Fixtures workspace, the current page of fixtures will be replaced by select buttons for each individual fixture cell. On fader handles, the unfolded fixture cells will start at handle 1.

There are two ways to unfold fixture cells:

- Press <Unfold> then select range of fixtures. The cells will immediately appear on the handles.
- Select fixtures, press <Unfold>, then press [Selected Fixtures]. This method allows for non-consecutive fixtures to be unfolded.

To go back to normal, press <Unfold> then [Exit Unfold].

You can also use the numeric keypad to quickly select cells. The syntax is as follows: (THRO is called Through on some consoles)

.	all sub fixtures of selection	n.	all sub fixtures of fixture n
. THRO .j	sub fixtures 1→j of all selected fixtures	n. THRO	all sub fixtures of fixture n→last consecutive of type n
THRO .j	shorthand for above	n. THRO i	sub fixtures 1→i of fixture n
.m	sub fixture m of all selected fixtures	n. THRO i.j	sub fixtures 1→j of fixtures n→i
.m THRO	sub fixtures m→last of all selected fixtures	n.m	sub fixture m of fixture n
.m THRO .j	sub fixtures m→j of all selected fixtures	n.m THRO	sub fixtures m→last of fixture n
.m THRO j	shorthand for above	n.m THRO i	sub fixtures m→i of fixture n
n THRO i.	all sub fixtures of fixtures n→i	n.m THRO i.	sub fixture m→last of fixtures n→i
n THRO i.j	sub fixture j of fixtures n→i	n.m THRO i.j	sub fixtures m→j of fixtures n→i
n THRO .j	sub fixture 1→j of fixture n	n.m THRO .j	sub fixtures m→j of fixture n

- Fixture cell selection can be saved as a group, this provides a quick way to select cells / sub fixtures without having to use the Attribute Editor or Unfold.

5.1.5 CHANGING ATTRIBUTES USING THE WHEELS

“Attributes” are the functions of the fixture, like pan, tilt, colour, dimmer, etc. You select which attributes you want to modify using the Attribute Bank buttons and set values using the wheels. The attributes available depend on the fixture type. Dimmer channels only have a dimmer attribute.

You can also select attributes by touching the IPCGBES buttons on the touch screen, and modify them using the Attribute Editor workspace window; this is described in the next section.

On the Pearl Expert the wheels on the Touch Wing are used instead of the wheels on the console, unless you change this using the User Settings.

Each attribute button controls several attributes, one on each wheel. On Sapphire Touch the trackball always controls pan/tilt of the selected fixtures, with the ring controlling fine tilt.

1> *With some fixtures selected, press the button for the attribute to be changed*

- 2> Turn the wheels to set the attribute. The display above the wheels shows which attributes are being controlled, and the settings which are available scroll up and down as you turn the wheels.

You can also touch the roller image on the screen to change the attributes up or down by one. For continuously variable controls like a dimmer, touching the roller will set the attribute to full or zero.

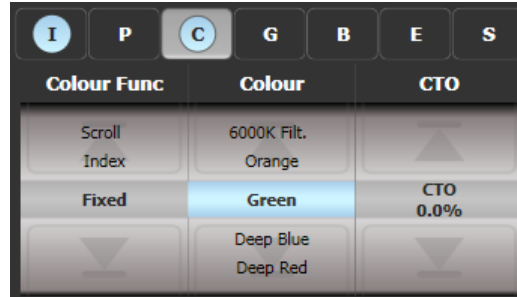

- 3> Repeat from 1 to change other attributes of the selected fixtures.

Some other things to know about attributes:

- If an attribute is in the programmer, it is highlighted (as shown with the “Green” setting in the screen picture above). This provides a quick way to see which attributes are in the programmer.
- You can also select the attribute to be changed from the softkeys by pressing the “Attribute Options” button.
- If the display above the wheels does not show the attribute when you press the button, that attribute is not available on the selected fixtures.
- If the wheel display shows a small arrow next to the legends, this means that there are further attributes to control. Press the Attribute button again to toggle through the attributes.

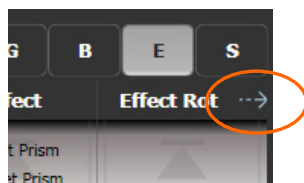

- The wheels operate in an “acceleration” mode. If you spin the wheel fast, the fixture changes in larger steps. If you move the wheel slowly, the fixture moves in its smallest increment.
- Holding down the <Avo> button while turning a wheel puts the wheel into “Fast” mode. When in this mode, a single rotation of the wheel changes the attribute you are controlling over its full range. For example, if while moving the Pan wheel you hold down <Avo> the fixture will make a complete pan movement between end stops in one rotation of the wheel.
- Some LED colour mixing fixtures have a Virtual Dimmer function (using the Intensity wheel) which offers intensity control by mastering the RGB levels when the fixture itself does not provide an intensity channel.

5.1.6 ATTRIBUTE WHEEL DISPLAY

The touch display above the wheels shows the attribute bank (Intensity, Position, Colour and so on) and the current values on the wheels.

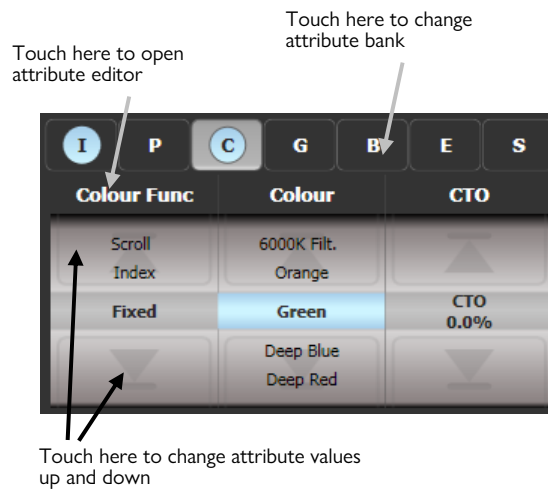

Touch the IPCGBESFX attribute bank buttons to change to a different bank. You can also use the physical attribute bank buttons as usual. The current attribute bank is shown with a grey background.

If attributes have been modified, the attribute button has a pale blue highlight.

The Roller display shows the attributes available on each wheel. These may be shown as a percentage value, or named values for attributes with fixed positions such as a colour wheel. If the attribute has been modified, the current value in the programmer is highlighted in blue.

You can touch the roller image to change the attribute to the next/previous value. For continuously variable controls like a dimmer, touching the roller will set the attribute to full or zero.

5.1.7 ATTRIBUTE EDITOR WINDOW

For attributes with fixed values such as gobos and fixed colour wheels, the Attribute Editor window can be easier to work with than the wheels. It also offers a colour picker window for fixtures with RGB or CMY colour mixing.

Press <View/Open> then [Open Workspace Window] then [Attribute Editor] to show it. As a shortcut you can also show it by touching the attribute name text just below the on-screen IPCGBES buttons.

The buttons on the left of the window select the attribute to change.



The rest of the window contains buttons or controls to set the attribute value. For attributes such as gobos and fixed colours, a button is provided for each one, making selection a lot quicker than scrolling through on a wheel.

When you apply an attribute, the button turns blue to show that the attribute is in the programmer. If you touch the button again, the attribute will be removed from the programmer.

Touching the title of an attribute (such as “Gobo 2”) expands the attribute to the full window, displaying more buttons as shown below. Gobo images will be shown if the fixture personality has the information included (not all do).



If an attribute has a range of values, sliding your finger left and right on the button will show a horizontal slider which allows you to adjust the attribute.

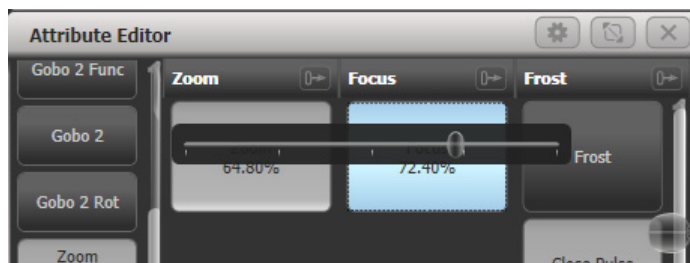

When the selected fixture has subfixtures or cells, buttons appear at the top of the attribute editor window allowing you to select the whole fixture (left hand button), or

individual cells for control. The layout of the cell buttons matches the layout set in the pixel mapper to help you locate the correct cell on the fixture.

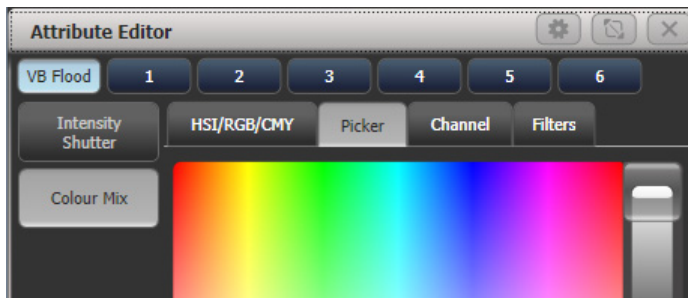

Some types of attribute have special displays as follows:

INTENSITY/SHUTTER



Provides an easy slider for Dimmer, also buttons for 0%, 100%, up and down 5%, and intensity locate (affects only the intensity).

POSITION

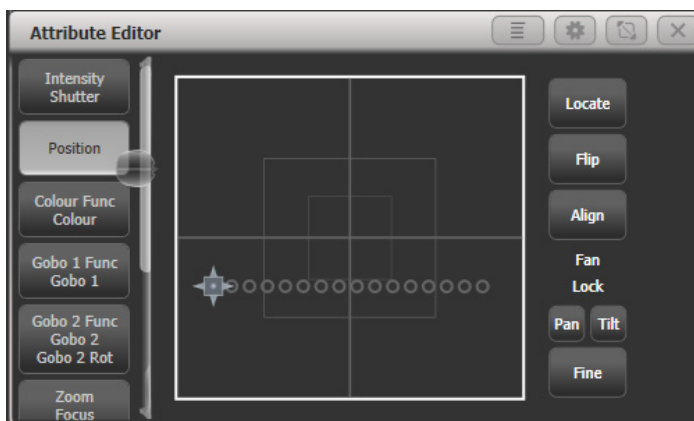

Provides a way to set the position from the touchscreen using an X-Y grid. Positions of selected fixtures are shown as circles on the grid which is useful to check positioning or spacing of fixtures. Other controls are provided:

- Locate sets 50/50 position (other attributes not affected),
- Flip sets a moving head to its opposite yoke position (see section 5.1.18 on p125)

- Align sets pan/tilt to match the settings in the programmer of the most recently selected fixture. For example if you want to match the tilt of 4 fixtures to the first fixture, select fixtures in the order 2-3-4-1 and press [Align].
- Pan/Tilt lock buttons are helpful when setting positions of multiple fixtures using the X-Y grid. For example if you have 10 pan-fanned fixtures and you want to just move the tilt, select Pan lock. Otherwise the fixtures will all move to the position you click on, losing the fan effect.
- Fine button switches to fine control mode for more precise positioning.

COLOUR MIX: HSI/RGB/CMY

For fixtures which are capable of colour mixing, there are several ways you can select a colour which are selected by tabs at the top of the Attribute Editor window.

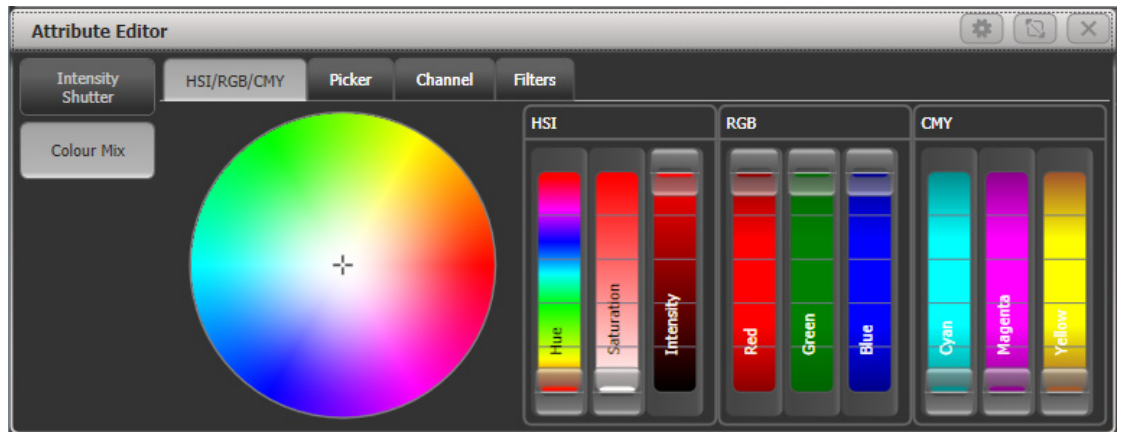

HSI/RGB/CMY provides a colour wheel with interactive sliders for changing Hue/Saturation/Intensity, Red/Green/Blue, and Cyan/Magenta/Yellow. Changing any slider or clicking on the wheel will adjust all other sliders to match that colour, allowing you to make easy small adjustments of colour using whichever control is easiest; for example use the Saturation slider to create a pastel version of a colour without affecting the hue.

All types of slider work for all fixtures, so a fixture with CMY mixing can still be controlled using the RGB or HSI sliders.

COLOUR MIX: PICKER

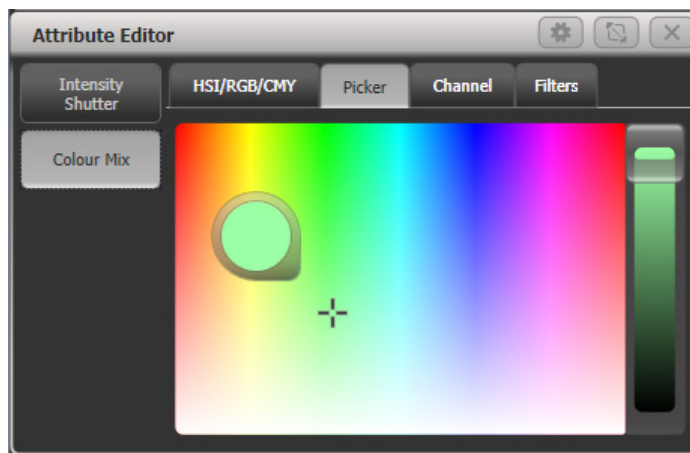

This is the classic colour picker from earlier versions of Titan which provides a picker for hue and saturation, with a slider on the right hand side to set the intensity.

COLOUR MIX: CHANNEL



Provides a slider for each colour control channel in the fixture. The sliders shown will vary depending on what is provided in the fixture - this example is an ETC Lustr fixture which has 7 independent LED colours. This mode is useful to obtain colours such as tints of white or UV/Congo Blue which are hard to mix from a picker or colour wheel.

COLOUR MIX: FILTERS

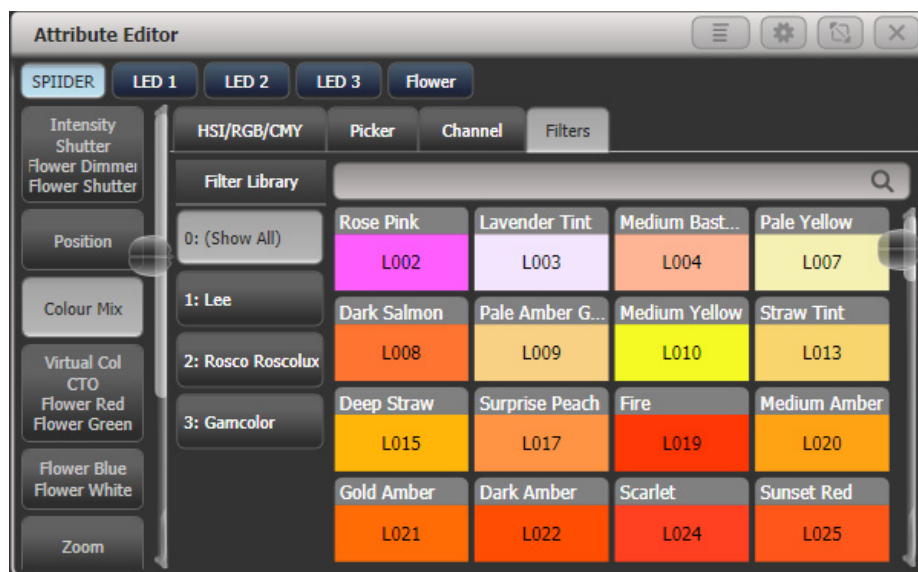

Lets you pick a gel/filter colour from the Lee, Roscolux or GamColor ranges of filters. You can search for a particular colour by name or by number using the search bar. There is a context menu button to [Order Filters by Number] or [Order Filters by Hue].



For LED fixtures with additional emitters for Warm/Cool white, Amber, UV, Lime or Cyan, Colour Mix will automatically control all the colour channels to obtain the colour. In versions previous to Titan v9 only RGB elements were controlled by the colour picker and other colours had to be set independently.

MEDIA SERVERS/ACTIVE FIXTURES

Active fixtures such as media servers will display a thumbnail of the media clip in the button. The media server must support CIP and be patched as an active fixture for the thumbnails to work.

For Ai media servers please see Section 12 on page 269 for more details of how Synergy allows you to control the setup and media playback.



SHUTTER BLADES/KEYSTONE

Fixtures which support keystoneing or blades/shutters can be controlled graphically in the attribute window. Select and drag the corners or sides of the image to control the fixture.

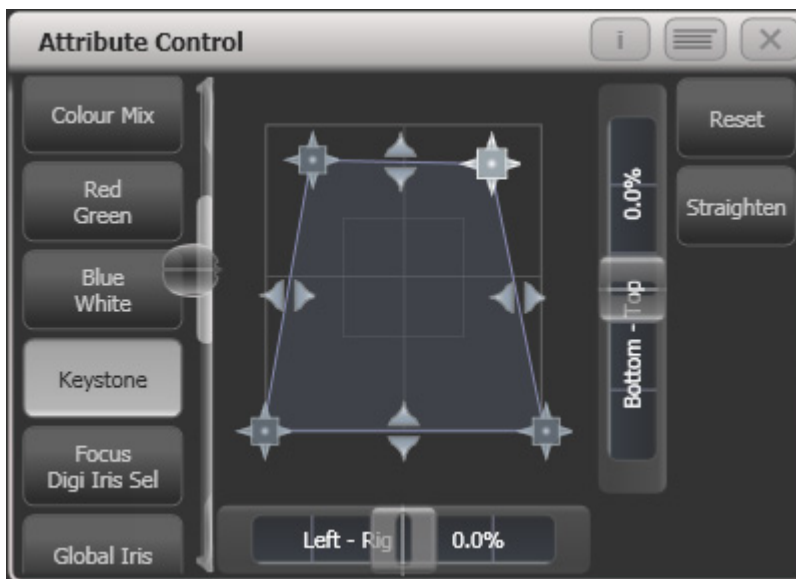

Updated personality files may be required to support the keystone/blade functions. If the functions are not shown in the Attribute View, try downloading and installing the latest personality file, then run the Update Patched Fixtures command.

5.1.8 SETTING ATTRIBUTES FROM THE SOFTKEYS

You can directly enter a numeric value for the attributes which are live on the wheels. You must be at the main Program menu to do this (keep pressing <Exit> until the vertical menu bar shows "Program Menu").

Type a number on the numeric keypad then press one of the softkeys to set the value to the fixture. The Softkey legend will show what effect your value is going to have (such as [Gobo 5], or [Deep Blue]).

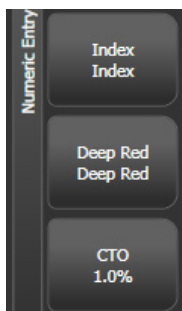

For attributes displayed in percent, such as Dimmer, or Colour Mix, you enter a value from 0-100 to set the percentage output. For attributes where the output is divided up into ranges, such as colour wheels, you enter the index of the range you want. For example to select the 3rd colour (as displayed in the list above the wheel) you would enter 3.

5.1.9 ADJUSTING ATTRIBUTES WITH THE @ BUTTONS

Pressing the <@> button next to a wheel opens the Adjust Attribute Value menu for that attribute.

You can also open this menu by touching the centre of the on-screen wheel view for the attribute, or by clicking on the attribute in the Channel Grid window.

(On Tiger Touch Mk1 the three buttons between the wheels act as @ buttons. On the Pearl Expert you will need to use the touch screen method.).

The menu gives you the following functions:

- Select Function: gives you shortcuts on the softkeys to the possible settings for the attribute (for dimmers, a range of values is provided).
- Touch/Clear: places the attribute in the programmer or removes the attribute from the programmer
- Locate: locates the attribute (does not place in programmer)
- Release: releases the attribute
- Off: sets the attribute to Off. This temporarily disables the attribute, though its value is stored and can be restored with On.
- On: sets the attribute to On (when merged to a cue or palette, On will restore a value which has previously been set to Off)
- Freeze/Unfreeze: freeze or unfreeze the attribute

5.1.10 SELECTING FIXTURES AND DIMMERS BY NUMBER (CHANNEL)

In some situations, for example when programming lots of dimmers, it can be easier to type in the dimmer channels you want to program. The Channel menu allows you to do this for dimmers or fixtures. To access the Channel menu, press the <Fixture> button

on the top left of the numeric keypad. You can also simply start typing numbers on the keypad, when you press Through, And or @ then the Channel menu will be shown.

Through, And and @ are provided as softkey functions or (depending on console) are buttons adjacent to the numeric keypad.

Fixtures may be selected by User Number, Handle Number or DMX Address, as set by the option on Softkey A.

When using the Channel menu it is helpful to latch it by pressing <Menu Latch>.

- To select a fixture, type the number and press <Enter>.
- To select more than one fixture, press the [And] softkey between each number. For example 1 And 2 And 5 <Enter> will select 1, 2, 5.
- To select a range of fixtures, press [Through]. For example 1 Through 8 <Enter> will select 1-8. If you miss out the last number it will select all remaining fixtures of the same type.
- To miss out fixtures in a range, use [Not], for example 1 Through 4 Not 3 <Enter> will select 1, 2, and 4.
- The @ softkey sets a dimmer level to the selected fixtures, for example 1 Through 8 @ 5 <Enter> will set 1-8 at 50%. (You can choose whether 50% is entered as "5" or "50" in the User Settings – see section 16.1.6 on page 320). When you press @ there are softkey options for Full, Off and +/- (increase or decrease brightness).
- You can work with Groups using the Group button, for example Group 1 And Group 2 Not 5 <Enter> will select all fixtures in group 1 and group 2 except for fixture 5.
- You can use <Locate> instead of <Enter>, to select fixtures and locate them. For example 1 Through 4 <Locate> will select fixtures 1 to 4 and locate them.

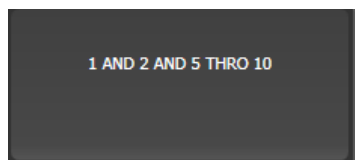

- When entering a command, the command line is shown on the display. You can go back using the grey Back button and you can abandon the line using the grey @ button.
- The AND, THRO and @ functions are also provided on the grey buttons either above or below the numeric keypad, as printed on the legend next to the buttons.

5.1.11 SELECTING FIXTURES USING A PATTERN

When programming you will often want to select patterns of fixtures. Rather than having to individually select and deselect fixtures, Titan has an easy way of selecting patterns of fixtures within a range.

| 1> *Select some fixtures.*

- 2> Press the <All> button (labelled Odd/Even on some consoles).
- 3> Select a pattern from the softkeys. Your selection is modified so you will only be controlling, say, the odd fixtures.

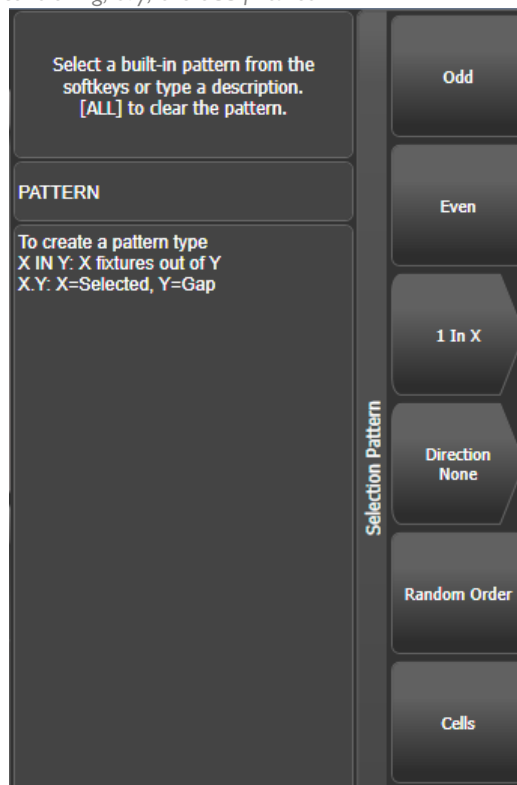

- 4> Press the <Fix+1> or <Fix-1> button to change the selection to the next stage of the pattern (<Next> and <Prev> on some consoles).
- 5> To end the pattern selection, press <All> twice.

- The Direction option allows you to set the fixture selection order to go in a specific direction (using the group layout). This is useful for selecting symmetrical pairs of fixtures and for quickly creating cues using overlap.
- Direction will return to “None” when you press Clear. You can change this by setting [Clear / Maintain Direction] in the [Clear Options] menu (hold the Clear button down to see this option).
- For example, if you are programming a chase using 16 fixtures and you want every 4th fixture to do the same thing, you just select the 16 fixtures, then press <All>, then [1 in x], then [1 in 4]. You will see that the 1st, 5th, 9th and 13th fixtures are now selected, and you can create the look for those fixtures. Then press <Fix+1>, and the 2nd, 6th, 10th and 14th fixtures will be selected ready for programming. After you have programmed the fourth set of fixtures, the pattern will go back to the first position again, until you press <All> twice to end.
- You can enter your own patterns using the numeric keypad and softkeys, for example “2” [In] “6” <Enter>.
- You can also get to these options by holding down a group selection button for the fixtures.

5.1.12 SELECTING FIXTURES WHICH ARE IN A PLAYBACK

To select fixtures which are controlled by a particular playback use the Select If function.

To select fixtures used in a playback, press <Select If> then the playback button. (If the console does not have a <Select If> button, press <Fixture> then [Select If]. The <Fixture> button is at the top left of the numeric keypad and may be labelled <Channel> on older consoles.)

You can also use <Select If> with the <@> and <Through> buttons on the numeric keypad to select fixtures set to a particular intensity.

@X: fixtures set to intensity X

@ Through X: fixtures with intensity 0 – X

@ X Through: fixtures with intensity X – Full

@ X Through Y: fixtures with intensity between X and Y

@@: fixtures with intensity above 0.

Intensity levels may be input as 0-9 or 00-99 depending on the User Setting [Channel Levels Set In] (see section 16.1.6 on page 320).

5.1.13 ATTRIBUTE GROUPS – IPCGBES-FX

To make life a bit simpler, the console groups together attributes which have similar effects, using the letters IPCGBES-FX.

I-Intensity (dimmer, strobe shutter)

P-Position (pan, tilt)

C-Colour (colour wheel, CMY mixing)

G-Gobo (gobo wheels, gobo rotate, gobo position)

B-Beam (iris, focus, zoom, beam shaper)

E-Effects (prism)

S-Special (motor speeds)

FX-Shapes, Pixel Mapper

These groups are used to select which attributes you want to work with in many of the functions on the console, particularly when you are “masking off” certain attributes from being saved.

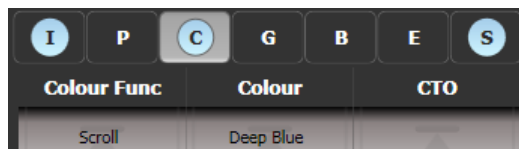

Above the attributes roller on the screen, the console shows you which attribute group you are currently changing (the grey box). The Attribute Group is also highlighted in blue if the programmer contains any of those attributes. For example in the image above we are currently changing Colour attributes, but Intensity and Special attributes have also been modified.

5.1.14 STEPPING THROUGH SELECTED FIXTURES ONE AT A TIME

If you have selected a range of fixtures, or a group, the console has functions to step through the selected fixtures one at a time. This can make it easier to program a range of fixtures because you don't have to select each one manually.

This mode uses the All/Hilight/Fix+1/Fix-1 buttons.

- 1> *Select a range of fixtures or a group.*
 - 2> *The <Fix+1> and <Fix-1> buttons will select the fixtures in the range one at a time (in the order you selected them). Buttons are labelled <Prev> and <Next> on some consoles.*
 - 3> *The <All> button will select all fixtures in the programmer (everything which has been selected since <Clear> was last pressed).*
- The Hilight function can be used to highlight the output of the selected fixture (make it brighter onstage), see the next section.

5.1.15 HIGHLIGHTING THE SELECTED FIXTURE WITH PREV/NEXT

When stepping through a fixture selection using <Fix+1>/<Fix-1>, you can highlight the selected fixture on stage. This makes it very easy to see which fixture you are controlling. The other fixtures in the selection go to a dimmed "lowlight" level.

- Press <HiLight> to enable highlight mode. Press <HiLight> again to disable. When you are in highlight mode, the highlighted attribute is overridden and any changes you make to it are not stored in the programmer (so if the highlight uses intensity, you cannot change the intensity of the fixture).
- You can change the levels used for Highlight/Lowlight by pressing <Record> then pressing <HiLight>, [Store Highlight State] or [Store Lowlight State].

5.1.16 TURN OFF UNSELECTED FIXTURES (REMAINDER DIM)

To turn off all unselected fixtures use the Remainder Dim function by pressing <Rem Dim> (<Avo>+<All>). The zero intensity is placed in the programmer and will be recorded into any cue. This is useful when removing fixtures from cues.

5.1.17 ALIGN FIXTURES

You can copy attributes from one fixture to another using the Align Fixtures function. This is very useful, for example, if you've accidentally left a fixture out of a cue you can copy settings from its neighbour.

You can align multiple fixtures to others in one operation, either using groups or individual selection. If you are aligning different numbers of fixtures there are options to set how this is handled, see below.

- 1> *Select the fixtures you want to Align either manually or using a group.*
- 2> *At the top level menu press <Fixture Tools>/<ML Menu> then [Align Fixtures].*
- 3> *Set the mask to include the attribute groups you want to copy (using the Attribute Bank buttons, or using the softkey options for exclude and include all attributes).*
- 4> *Touch the select button of the fixture or group you want to copy the settings from.*
- 5> *Press [Align]*

The fixture selection order is used to determine how the aligned values are copied.

- The [Auto Reset Mask] option will always set the mask to Include All whenever you enter the Align Fixtures function. The alternative option [Remember Mask] will leave the last mask set.
- [Spread Attributes] will try to spread out the attribute changes if there are a different number of fixtures in the source and target groups (best for positions). [Repeat Attributes] will repeat the source selection on extra fixtures, or attempt to mirror the fixtures if there are fewer.
- [Align Programmer Attributes] will only align the attributes which are in the programmer, [Align All Attributes] will align all the attributes which are enabled by the mask. So for example if you want to align the tilt of some fixtures and you have set the tilt you want on an example fixture, [Align Programmer Attributes] would only change the tilt; but [Align All Attributes] would copy the pan setting from the source fixture as well.
- [Palette References Maintained] will copy palettes from the source fixtures. [Palette References Lost] will convert the palettes to absolute values in the target fixtures.
- If the fixture you are copying the settings from is also one of the fixtures being aligned, it's difficult to tell what you are doing as all the fixture buttons light up red. However if you look at the top line of the screen, there is a list of the fixtures you have selected.

5.1.18 FLIP

Moving head fixtures can point at the same stage position from two possible yoke positions. Sometimes to get the fixture moving the same as other fixtures, you need to swap to the opposite yoke position and the Flip function lets you do that.

- 1> *Select the fixtures you want to Flip.*
- 2> *At the top level menu press <ML Menu> then [Flip Pan and Tilt].*

The Position window in the Attribute Editor also has a [Flip] button which does this.



The settings used for Flip are defined in the fixture personality. If Flip doesn't work you may need to update to the latest personality.

5.1.19 FAN MODE

Fan mode automatically spreads out the values on a selected range of fixtures. If used on pan and tilt, the result is spreading out "rays" of light beams. The first and last fixtures of the range are affected most, and the central fixtures are affected least. The amount of fan can be set using the attribute wheels.

As with shapes, the order in which you select the fixtures sets how the fan effect works. The fixtures you select first and last will be the ones which change most. If you use a

group to select the fixtures, the order you selected the fixtures when you recorded the group is used.

The fan effect, while normally used on pan or tilt attributes, can be applied to any attribute.

- 1> *Select the fixtures you want to fan.*
- 2> *Press <Fan>.*
- 3> *Select the attribute you want to Fan using the attribute bank buttons.*
- 4> *Set the amount of fan using the attribute wheels.*
- 5> *Turn off Fan by pressing the Fan button again when you have finished. Fan will turn off automatically if you change the fixture selection.*

If you have selected fixtures from multiple groups, you can choose whether the fan effect works with or ignores the groups. For example if you have 12 fixtures across the stage in 3 groups of 4, you may want a fan of light beams spread evenly across the stage, or you may want 3 groups of separately fanned light beams.

By holding down <Fan> you can select:

- [Ignore Groups] All fixtures are fanned as one large group
- [Fan Group as Fixture] All fixtures in a group take on the same value.
- [Fan Within Group] Fan runs across individual fixtures in each group.

Holding down <Fan> also allows you to select the Curve used for the fan. The different curves allow you to obtain different fan effects.

Fan mode needs to be used on at least 4 fixtures to give good effects. If you have an odd number of fixtures, the central fixture will not change in fan mode.

Press <Fan> again to leave Fan mode. Any effects you have set will remain in the programmer.



It's all too easy to accidentally leave Fan mode turned on and be very confused about why the wheels aren't working properly, so turn it off as soon as you have completed the effect. To avoid this there is a User Setting 'Press and hold Fan'. If enabled, you have to hold down <Fan> to enable Fan mode. See section 16.1.6 on page 320.

FAN CURVES

You can select different curves to use when in Fan mode. Hold down <Fan> and select [Curve], the options are:

- Line: Traditional fan, the first and last selected fixture are affected equally in opposite directions, the midpoint remains unchanged. This is most useful for pan.

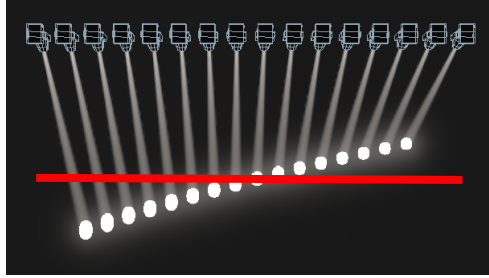

- Mirror- Divides the selection into two halves, the position in each half is the mirror of the other half

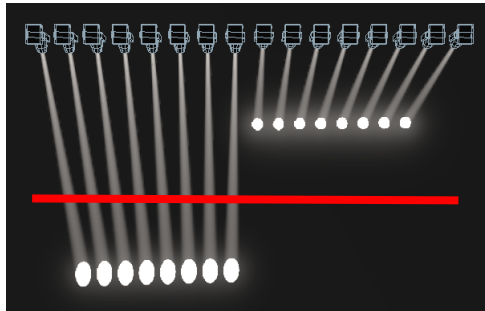

- Wings – Divides the selection into three parts, the positions in the outer two parts mirror each other and the central part does not change.

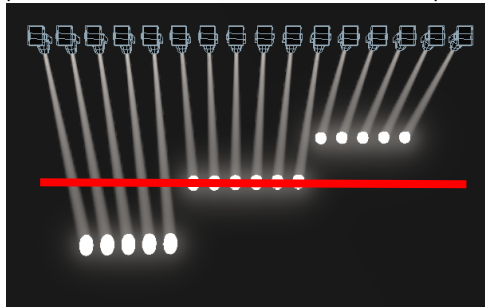

- Arrow - The first and last selected fixture are affected equally to the midpoint fixture but in the opposite direction. This is useful for colour mixing, tilt and dimmer.

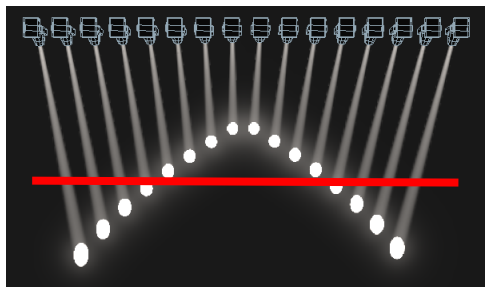

- Pull Middle - The first and last selected fixture remain at the current value, the midpoint is affected most. This is useful for colour mixing, tilt and dimmer.

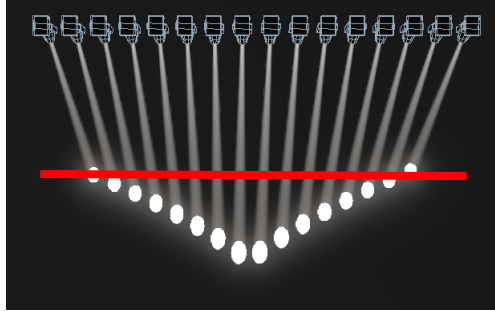

- Pull Ends - The first and last selected fixture are affected most, the midpoint is unchanged. This is useful for colour mixing, tilt and dimmer.

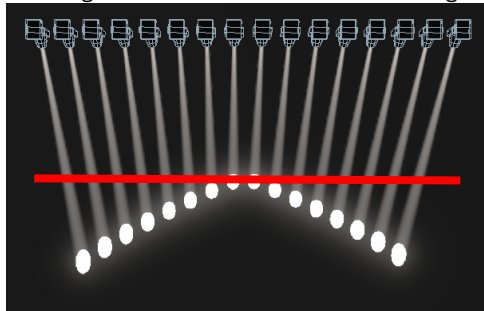

- Pull End – Like pull ends but only from one end, the other end does not change

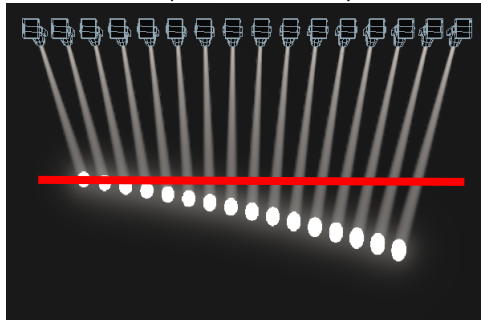

FAN PARTS

When using the Fan function you can split the fan into a number of groups. Select all the fixtures, hold down <Fan> and type a number on the numeric keypad. The Fan will divide into that number of parts, for example:

Normal (1):

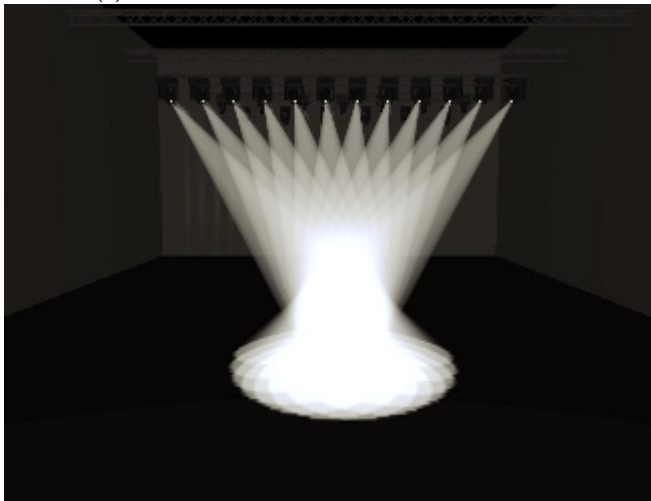

2:

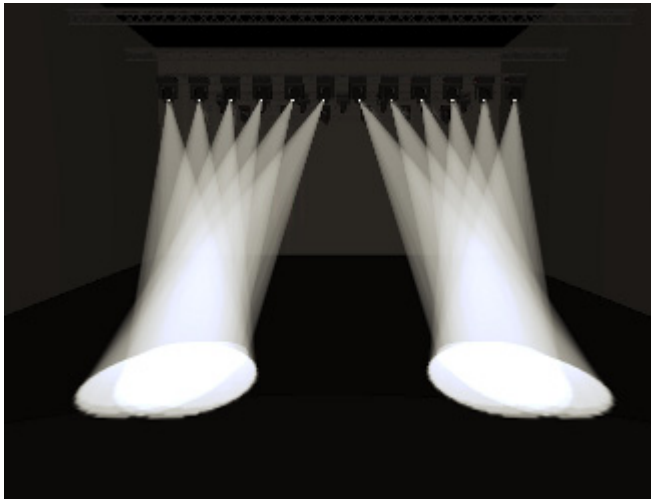

3:

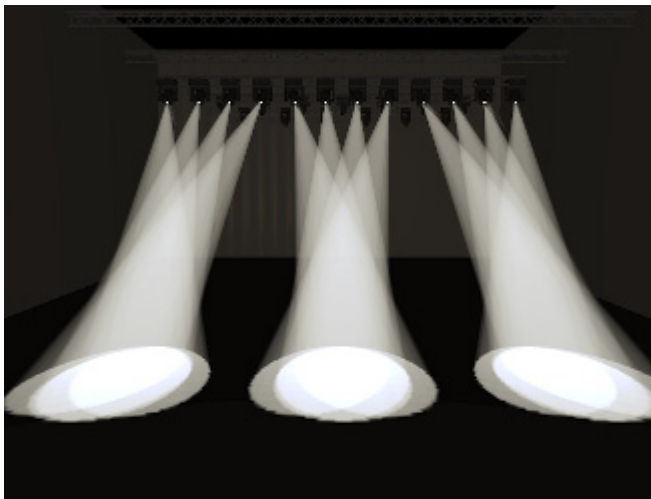

5.1.20 SETTING FIXTURE/ATTRIBUTE TIMES

Fade and delay timings can be directly set for each fixture or individual attributes of a fixture. When you store the settings into a cue, the time settings will then become part of the cue.

There are a number of ways to set the times:

- You can set individual attribute times by switching the wheels to Fade Time / Delay Time mode using the [Wheels=] softkey on the root menu.
- Individual attribute times can also be set using a combination of the wheel @ keys and the <Time> key.
- They can also be set by selecting fixtures and entering into the attribute times sub-menus from the <Time> key.
- There is also command syntax that allows various options to set attribute time values - e.g. <Time> <Fixture> <Position> 5 @ 3 would set a 5s fade, 3s delay time onto the current fixture selection P group. Wheel @ keys can also be used in the syntax. Fan options are also available through syntax using THRO.

Setting a time attribute value will cause the 'in programmer' indication to light up.

The Channel Grid window has a Times context menu button which allows you to view or edit all the attribute times currently in the programmer. You can set a time to Off to temporarily disable it; the On option will restore the previous setting.

You can try out time settings by pressing <Avo> + <Time> or double tap the <Time> button. (previously the <Set> button on Titan Mobile/Sapphire Touch and the <Next Time> button on Tiger Touch/Pearl Expert).

5.1.21 CLEARING ATTRIBUTES USING "OFF"

Once you have changed an attribute, the value you set will be in the programmer and will be stored in any cues or palettes you create. If you've accidentally changed something and don't want to store it, you can use the Off function to remove it from the programmer.

- 1> Press <Off> to display the Off menu.
 - 2> Use the Attribute Bank buttons to toggle which attributes you want to change. Then press the [Attributes Off] softkey to set them to Off.
 - 3> The softkeys also give you options to turn off active attributes, such as [Dimmer Off].
- To remove complete fixtures, select the fixtures, press <Off> then [Selected Fixtures Off].

5.2 VIEWING AND EDITING FIXTURE VALUES

5.2.1 THE CHANNEL GRID WINDOW

It can sometimes be useful to display and edit exactly what each fixture is doing. The Channel Grid window allows you to do that. Display it by pressing <View/Open> then [Open workspace window] then [Channel Grid].

Channel Grid												
Attributes		Number	IPGBES	Dimmer	Shutter	Pan	Tilt	Colour Macros	Colour Func	Colour	CTO	White
All	I	Robin600ES	101	- - - - -	F -	-	58.49	55.22		Fixed	Open	0.0
		Robin600ES	102	- - - - -	F -	-	36.51	59.01		Fixed	Open	0.0
		Robin600ES	103	- - - - -	F -	-	63.67	59.08		Fixed	Open	0.0
		Robin600ES	104	- - - - -	F -	-	44.33	56.06		Fixed	Open	0.0
		Robin600ES	105	- - - - -	F -	-	66.90	34.02		Fixed	Open	0.0
		Robin600ES	106	- - - - -	F -	-	67.14	37.55		Fixed	Open	0.0
		Robin600ES	107	- - - - -	F -	-	67.10	64.37		Fixed	Open	0.0
		Robin600ES	108	- - - - -	F -	-	32.42	34.05		Fixed	Open	0.0
		Robin600ES	109	- - - - -	F -	-	65.26	35.27		Fixed	Open	0.0
		Robin600ES	110	- - - - -	F -	-	39.41	42.83		Fixed	Open	0.0
		Robin600ES	111	- - - - -	F -	-	60.06	42.83		Fixed	Open	0.0
		Robin600ES	112	- - - - -	F -	-	35.03	37.34		Fixed	Open	0.0

The window can be set to different modes using the context buttons to the left of the menu. The modes are:

- All / Stage / Programmer / Selected: lets you filter which fixtures are shown in the list. Stage lists all fixtures with dimmer above zero.
- Sort: Sets the list order as User Number, Last Selected or DMX Address
- Open Intensity View: Opens the intensity view window. You can swap back to the Channel Grid by pressing the Open Channel Grid button in that window which is in the same position.
- Show/Hide Palettes: lets you show which palettes are allocated to fixture attributes
- Playbacks / Levels / Shapes / Effects / Times: Only one of these buttons can be selected, and sets what is displayed in the columns.

You can **select** fixtures by touching the fixture names on the left of the screen, or if you select any fixture values, the appropriate fixture will automatically be selected.

You can **clear** attributes in the channel grid by selecting them (touch or touch and drag to select multiple attributes). Then press <Clear>.

You can **edit values** by selecting one or more values in the grid, then modify the values using the wheels, or type a new value on the numeric keypad and press <Enter>.

You can filter what is shown in the grid either by IPCGBES attribute (using the buttons top left) or by fixture type (using the buttons below that).

5.2.2 INTENSITY WINDOW

If you want to see at a glance the intensity setting of each fixture, the Intensity window is the place to be. To show the window, press [Open workspace window] then [Intensity].

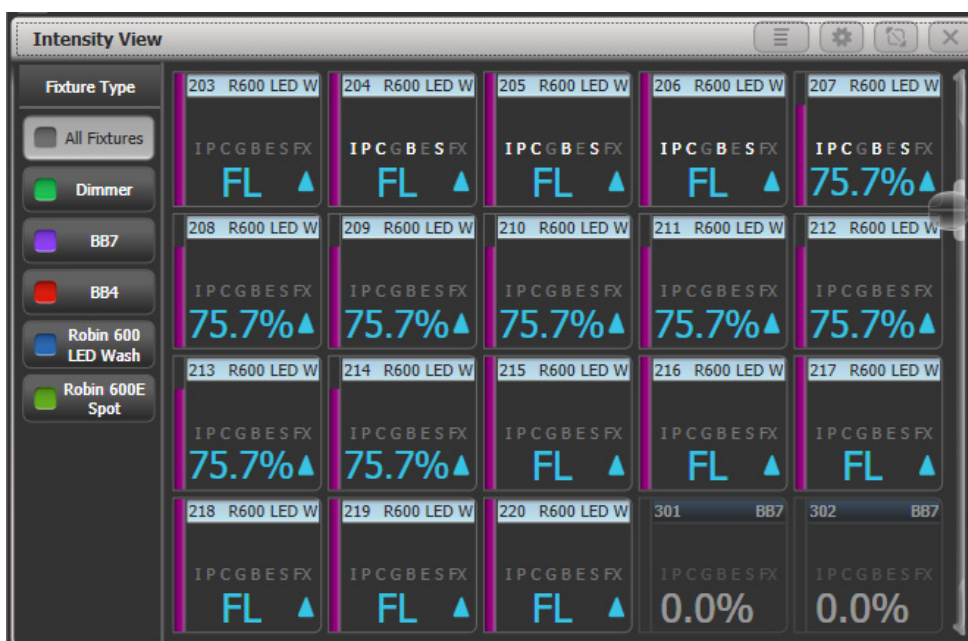

Each fixture has a block showing the intensity as a number and as a bar down the left side. The header bar shows selection/programmer state like fixture buttons – blue for selected and cyan for in programmer.

Rising or falling intensity is shown with a blue up arrow or a green down arrow.

Tracked values from previous cues are shown with a magenta equals sign.

In a solo or block cue a red “not permitted” symbol is shown.



If intensity levels are controlled by an effect they are shown in yellow with a tilde symbol (~).

If the intensity is controlled from a cue or cue list the name of the cue will be shown.

The IPCGBESFX states of the fixture are also highlighted if any attributes have been set in the programmer.

If colour halos are set for the fixture buttons, the halo is also displayed around the fixture intensity. This option can be changed to show the automatic fixture colours, see below.

- Filter the view to show only a certain type of fixture using the buttons on the left
- Change the display order of the fixtures using the [Sort] context menu buttons – User Number, Last Selected or DMX Address.
- Click on a fixture to select it, you can then edit the intensity directly.

- Press <View/Open> followed by a fixture button to show more detailed information about the fixture.

The context menu options give you settings to change how the window is displayed.

The first option lets you only show fixtures in a particular state:

All – all fixtures (default)

Stage – fixtures with intensity above zero

Programmer – fixtures in the programmer

Selected – fixtures which are selected

Live cues – only intensities coming from active cues

Connected cue – only fixtures in the currently connected cue (for cue lists or chases)

Frozen – fixtures with frozen intensity

The second option changes sort order as described above

[Search] allows you to enter characters to search for in the legend or user number, matching fixtures will be shown as you type. When Search is active a search bar is shown at the top of the window, click the X to remove the search filter or click on the text to modify the search string.

[View If] lets you click on a group and/or playback to show only the fixtures in that group or playback. For a chase or cue list, this will include all fixtures in all the cues of the chase/list. The filter settings are shown in a bar at the top of the window, click the X to remove the filter or click on the bar to change the group/playback.

[Open Channel Grid] opens the Channel Grid window described in the previous section.

In the **Window Appearance Settings** (cog button) there are further display options. Turning off some of the options will reduce the size of each fixture button which may be useful if you want to get more fixtures on the screen.

- Filter Fixtures Shown/Hidden: Shows or hides the fixture selection buttons on the left
- User Number Hidden/User Number Shown/DMX Address Shown: Sets what information is shown in the top left corner of the button
- Legend Shown/Hidden: Sets whether the fixture legend is shown in the top bar
- Cue Information Shown/Hidden: Sets whether the button shows the current cue information
- Attribute Mask Shown/Hidden: Sets whether the button shows the IPCGBESFX settings
- Halo Colour Custom/Auto: If set to Custom, buttons will have a halo colour if you have set one, otherwise they will not have a halo. If set to Auto, buttons will be coloured using the automatic fixture type colour used in the filter buttons on the left.
- Fixture Cells Shown/Hidden: If set to Shown, separate buttons are shown for cells (sub-fixtures) of any multi-celled fixture, along with a master intensity.
- Tracked Fixtures Shown/Hidden: (This option only appears when the view is filtered to Live Cue or Connected Cue). Sets whether fixtures with tracked intensity are shown or not.

5.3 FIXTURE GROUPS

5.3.1 USING FIXTURE GROUPS

You can create groups of fixtures or dimmer channels, which can then be quickly selected together by pressing a single button or typing the group number. You can, for example, make a group for each type of fixture, then also group by stage left / stage right, etc.

If you have a lot of fixtures, clever use of groups will greatly increase your programming speed.

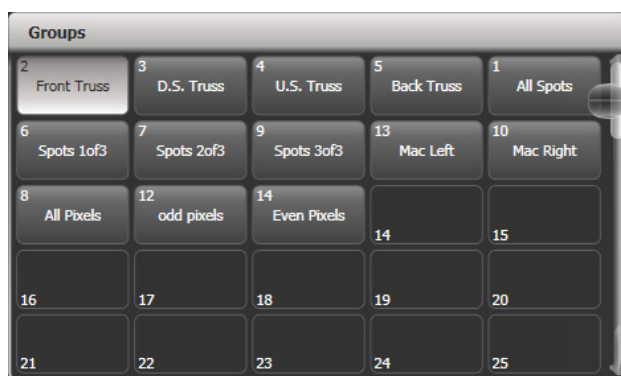

Groups can be stored in the Groups window, on fader handles or on Macro/Executor buttons.

If you assign a group to a handle with a fader, the fader becomes an intensity master for the group. You can also set different functions for the buttons using Key Profiles. See section 13.1.5 on page 286 for more details.

If the Groups window is not visible, you can show it by pressing <View/Open>, <Group> (above numeric keys).

- 1> Select the fixtures/dimmers you want in the group (the order in which you select them will also be stored in the group).
 - 2> Press <Group> (top right of the numeric keys) then [Record Group]. You can also press <Record> then <Group>.
 - 3> Use softkey A to enter a number for the group, or B [Provide a legend] to set a legend.
 - 4> Touch an empty button in the Groups window, or press the grey button of a fader handle where you want to store the group (not the main playback faders), or press C [Store] to store as a numbered group.
 - 5> Press <Clear> then repeat from 1 to store other groups.
- You can also press <Avo> and <Group> to go directly to the Record Group menu, or on the screen touch the button twice to use Quick Record – on the first touch the button will turn red with a +, on the second touch the group will be recorded.



- To select all the fixtures/dimmers in a group, just press the button for the group.
- The order in which you originally selected the fixtures when creating the group is also stored. This takes effect when you use the last fixture – next fixture functions described in the next section, and when you use Shapes, Fan mode and Fixture Overlap functions. You can change this later, see the next section. You can override the selection order while recalling a group by holding down the group button and using the softkey options.
- You can also recall a group by its number:
 - 1> Press <Group>.
 - 2> Type in the number of the group you want to recall.
 - 3> Press [Recall Group].
- The <Group> button also gives you facilities on the softkeys to edit and delete groups.
- You can use <Select If> to deselect a group of fixtures from a selection. This can be useful to select a subset of fixtures from a group. For example if you have a group for the outside edges of a 5x5 matrix, and a group which selects odd and even pixels from the matrix, you can select the outside edge, then use <Select If> with the odd/even group to remove the alternate pixels round the edge.

DELETING FIXTURES FROM GROUPS

To remove fixtures from a group:

- 1> Press <Group>.
- 2> Press the button for the group you want to change. All fixtures currently in the group will be selected.
- 3> Deselect the fixtures you want to remove from the group.
- 4> Press <Exit>.

The group will now only contain the fixtures which remained selected.

AUTO GROUPS

When patching multiple fixtures, the console automatically creates groups for you. A fixture type group is created which contains all fixtures of the same type (for example, [All Robe Pointe]). Another group is created each time you patch a quantity of fixtures (for example, [4 BB4].) This function can be turned off using [Auto Groups] in the User Settings.

5.3.2 FIXTURE ORDER AND FIXTURE LAYOUT IN GROUPS

Fixtures in a group are stored with a selection order, which is used with Shapes, Fan, and Overlap. You can also store a 2D position layout for fixtures, giving the actual physical location of fixtures for use with Shapes or Pixel Mapper effects or when selecting fixtures using patterns.

To change the numerical fixture order:

- 1> Press <Group>.
- 2> Select the group you want to edit.

3> Press [Fixture Order].

The fixtures in the group will be shown numbered in the fixtures window.



To change the order, select [Auto Increment] to On, then select the fixtures in the order you want. If you press a fixture twice, it will show an X indicating that it is not part of the sequence.

To change the 2D fixture layout:

- 1> Press <Group>
- 2> Select the group you want to edit.
- 3> Press [Edit Layout]. The Layout Editor window will open.

Initially fixtures will be all in a row. You can reposition the fixtures anywhere on the screen by dragging them. Or press a fixture to select then use the wheels to move it around the grid. You can resize the grid by dragging the bottom or right sides.

Multi-celled fixtures appear showing all the cells but when moved or rotated, move as a block. Depending on the fixture personality, sometimes the cells may not match the actual physical layout of the cells on the fixture.

The [Arrange Fixtures] context command will automatically place the fixtures in a rectangular block, you specify the number of rows (Height) and columns (Width).

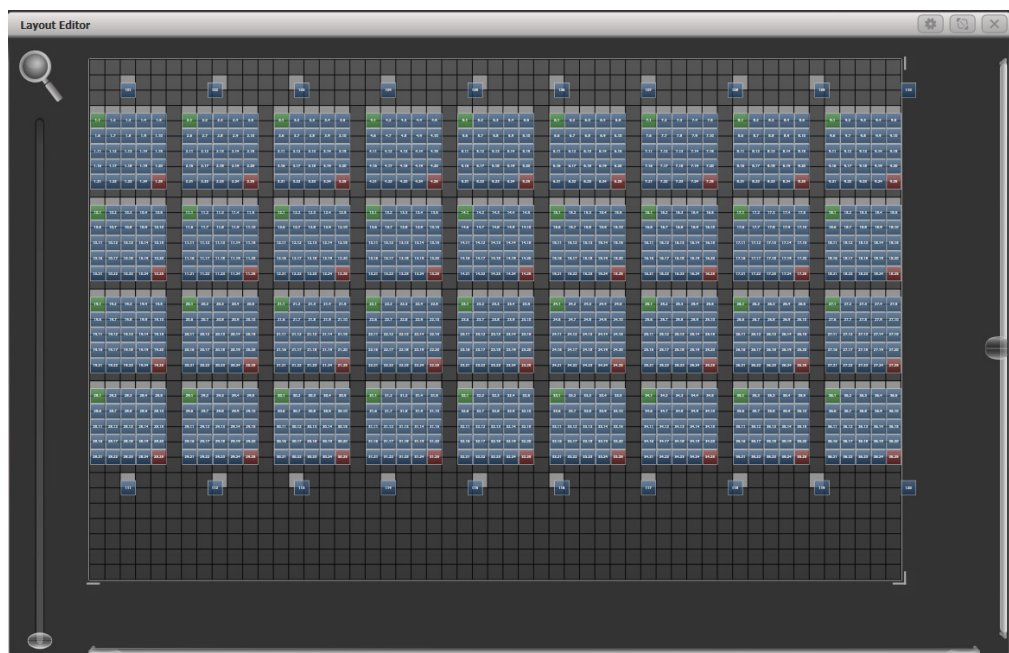

- The X-coordinate of the fixture layout is the same as the Fixture Order. Changing one will cause the other to change.
- When setting the grid size, think about leaving space between fixtures to more accurately match the real world layout, and make sure you have enough cells in the grid for all the cells of the fixtures you need to fit in.
- It is possible to accidentally overlay one fixture on another, making the bottom fixture hidden. To access overlaid fixtures, drag off the fixture which is hiding it, or select the hidden fixture and use the wheels to move it somewhere visible.
- You can use the Fan button to evenly spread fixtures in the layout.
- To move or rotate fixtures, select and drag, or use the wheels. You can click on the “up” and “down” areas in the wheel display to nudge the values up and down – 1 pixel for position and 45 degrees for rotate. If you press the @ button for the wheel, a window opens allowing you to type in the values numerically.
- If you click the context menu button [Position and Angle] it will change to [Scale] which allows you to spread out or compress the cells in a multi-cell fixture. This is useful to get cells located correctly if you have some fixtures with large cell spacing and some with small spacing.

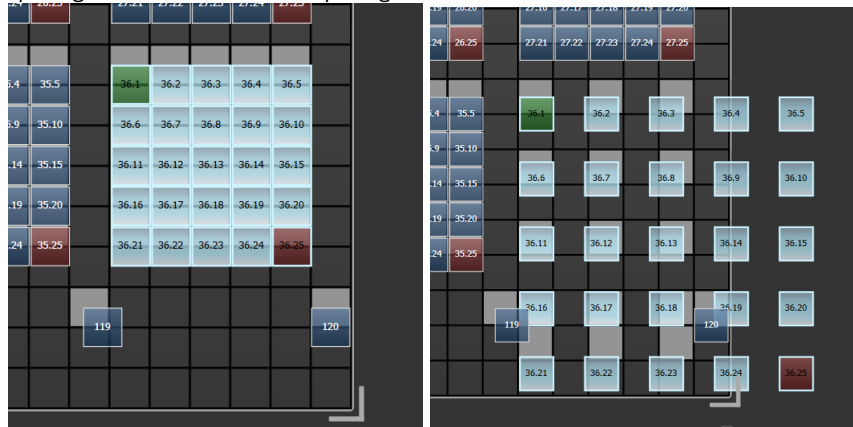

- The Layout Editor is described in more detail with examples in the Pixel Mapper section 7.6.4 on page 185. There are also some features to help with Synergy/Ai mapping which are in section 12.2.5 on page 279.



You can temporarily randomize the fixture order when selecting fixtures using a group by holding down the group button and pressing [Random Order] which appears as a softkey option while the button is held.

5.4 ADVANCED OPTIONS

5.4.1 THE ML MENU BUTTON

When the console is at the top level menu, this button opens the Moving Light Actions menu which contains options to Locate Fixture (same as the Locate button) and to run Macros on fixtures such as Lamp On, Lamp Off, Reset etc. The Align Fixtures and Flip functions as described above are also in this menu.

On the Pearl Expert and Tiger Touch Mk1, this button also latches the current menu when the console is not at the top level menu. Press <Exit> to get back to the top menu so that you can access the Moving Light menu. On other consoles there is a dedicated <Latch Menu> button.

5.4.2 LAMPING FIXTURES ON AND OFF

Many fixtures have a control channel which allows you to perform functions like lamp on, lamp off, fixture reset, and so on. This can be useful to shut down fixture lamps at the end of a show while the fans continue to run, or to reset a fixture which has gone haywire.

The console allows you to access these functions using Fixture Macros (not to be confused with keypress macros).

- 1> *Keep pressing <Exit> until you are at the top level menu.*
 - 2> *Select the fixtures you wish to control. Macros may not work across groups of fixtures from different manufacturers so it's best to do each type of fixture separately.*
 - 3> *Press <Fixture Tools>/<ML Menu> then [Macros].*
 - 4> *The softkeys show a list of the functions available. Press the one you want to action.*
- Some macros involve timed sequences and can take up to 30 seconds to execute.

6. PALETTES

When programming a show you will find that you frequently use certain positions, colours, etc. The console lets you store these settings so you can recall them at the touch of a button rather than having to find them on the wheels every time. This is very useful for rapid programming and when busking a show.

When you use a palette to record a cue, the console stores a reference to the palette, rather than the actual value. This means that if you program your cues using palettes, you can easily change all the positions in your show just by reprogramming a few palette entries rather than having to reprogram all the cues. This is handy if you are touring and have to cope with different stages or truss heights every show.

Palettes can be nested so you can use palettes in other palettes. If you change a master palette, the changes will track through to all the palettes in which it is used.

Palettes are stored and selected using the buttons in the Colours, Gobos/Beams and Positions windows. You can also store palettes on the grey buttons of preset fader handles (but not on the main playback faders) and on Macro/Executor buttons. You can set a legend for each button so that you know what you're going to get.



If the Colours, Positions, Gobos & Beams windows are not shown, press <View/Open> then [Open Workspace Window] then [Groups and Palettes] to show all three windows.

6.1 CREATING PALETTES

6.1.1 WHICH ATTRIBUTES ARE STORED IN PALETTES

Although each palette entry could store all attributes of a fixture, it's easier to operate the console if you create some palettes which only set positions, some for colour, some for gobo and so on. The console helps you with this by providing separate windows for Colour palettes, Position palettes, and Gobo/Beam palettes.

When you store a palette, it will only contain what's in the programmer (the attributes you have changed since you last pressed Clear). For example to create a colour palette you would just set the colour, and not change any other attribute. You can also make palettes which contain effects such as shapes and pixel mapping. If fade or delay times are programmed for fixtures or attributes, these will also be stored in the palette, and you can also create palettes which contain only time information.

If the programmer contains more than one attribute, you can set a mask to restrict which fixture attributes will be stored in the palette.

Palette information may be **Global**, **Shared** or **Normal**. Global palettes work on any type of fixture. Shared palettes apply the same value to all fixtures of the same type – for example when setting colours, the “Red” palette would set the same colour values for “Red” to all MAC 2000 fixtures. Normal palettes are used when each fixture requires its own value - for example when programming positions, each fixture will have a different setting.

It is possible, by merging information into palettes, to create a palette which contains global, shared and normal attributes.

Available attributes for Global palettes are Dimmer, Pan, Tilt and Colour. When creating a global palette for a colour mixing fixture, both CMY and RGB attributes are calculated and a special “dynamic” value is added to colour wheel channels, the console will attempt to match the closest fixed colour wheel colour to the selected mix colour.

There is a User Setting “Minimum Palette Mode” which can force the console to record palettes in Shared or Normal mode.

6.1.2 STORING A PALETTE

This is how you save a palette value to one of the palette windows:. If the palette windows are not shown then press the “Groups and Palettes” workspace button.

- 1> Press <Clear> to clear the programmer.
- 2> Select the fixtures for which you want to store palette values.
- 3> Using the attribute buttons and wheels, set the attributes you want in the palette entry. You can store any or all attributes of a fixture in each palette entry.

- 4> Press <Record> then <Palette> (or <Palette> then [Record Palette]). Using Quick Record (see next section) you can skip this step, and the palette mask is set automatically to match the window.
 - 5> If you wish, set the palette mask – this sets which attributes will be recorded in the palette. Select attributes using the Attribute Bank buttons – anything lit up will be saved. [Set Mask] and [Record by] softkeys also control the Mask (see below).
 - 6> Touch a button in one of the palette windows to store the palette (if you touch a used button you will be given further options). Or enter a palette number and press [Store]
- If you want to record to a physical button, press <Record> then <Palette>. All buttons where you can store the palette will then flash, press one to store.

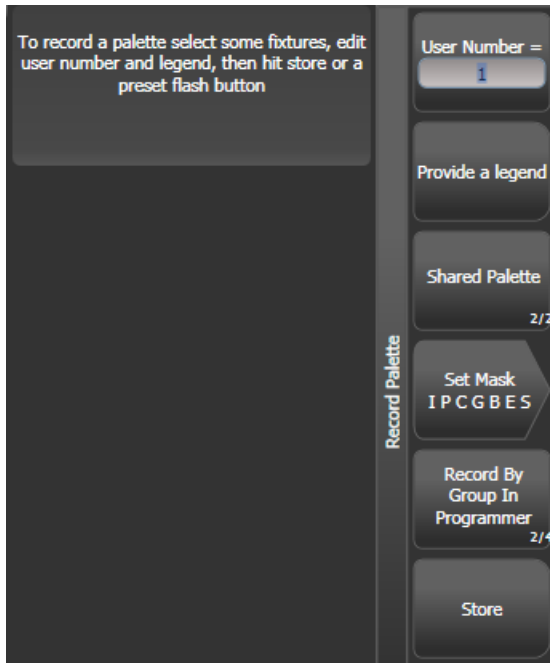

- The console will automatically set the palette as Global, Shared or Normal (by checking if the values to be stored are the same across all fixtures of the same type). You can override the setting by pressing softkey C. See below for more details of how this automatic choice works.
- [Set Mask] allows you to specify which attribute groups will be included in the palette. You can also use the grey Attribute Bank buttons on the right hand edge of the console to set the mask.
An attribute group is included when the softkey is inverted (like the Colour group in the picture) and when the LED is lit on the Attribute Bank button. If you use **Quick Record** (see next section) the mask is automatically set by the workspace window you save the palette in – Positions only includes P, Colours only C and Beams includes IGBES. If you use the <Record> button then you need to set the mask manually.
- Press the Attribute Options button to toggle each mask group between Include and Exclude.

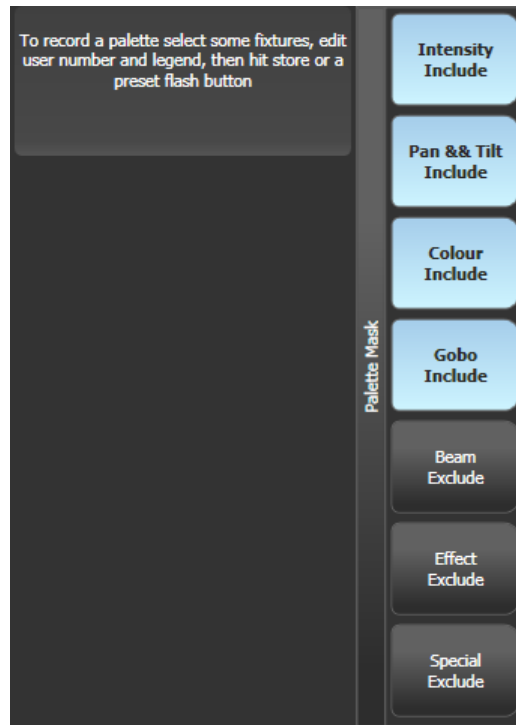

- [Record By...] allows you to control how the mask is used when saving the palette. The options are:
 [Channel in programmer] records only channels which are in the programmer (ones which you have changed)
 [Group in programmer] records all channels in any attribute group which has one or more channels in the programmer. For example if Cyan is in the programmer, all colour channel settings will be recorded even if not in the programmer.
 [Group in mask] records everything included by the mask set on the attribute buttons
 [Mixed] records by attribute group for Position and Colour but by channel for all other controls.
- The console will automatically create a legend for your palette (unless the User Setting [Auto Legend] is set to Off). For colour palettes a coloured icon is used to show the selected colour. If the palette contains fixtures set to different colours, a coloured bar will be shown for each. For CITP (media server) palettes, the media thumbnail will be used. For other attributes the last adjusted function value will be used for the legend, except for pan and tilt which will use a default legend.

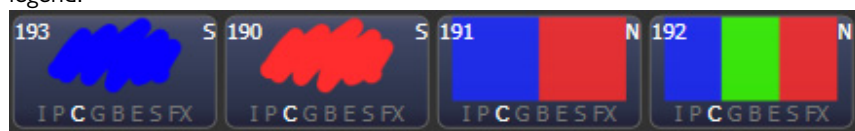

- You can also manually set a legend for the palette while you are saving it using [Provide a legend]. See section 6.1.5 for how to change the palette legend.
- If you select a Palette button which is already used, the console offers you options to [Cancel], [Replace], [Merge] or [Quick Merge] the existing palette. [Replace] will erase the palette and save only the latest changes you have made. [Merge] will combine your changes with the palette. [Quick Merge] will merge

only the attributes which are currently stored in the palette – the button shows you which attributes.

This allows you to add settings for additional types of fixtures to a shared palette or to update the existing fixture settings. Pressing the palette button again will automatically merge using Quick Merge.

- The console will select Global mode if the programmer contains the same values for all selected fixtures and one or more of the attributes is suitable for Global. If the values are the same but none of the attributes are suitable for Global the console will select Shared. If some attributes are suitable and some aren't, the console will record the suitable ones as Global and the others as Shared. If the values are different the console will select Normal. You can prevent the console from using Global and/or Shared modes using the "Minimum Palette Mode" option in the Palettes tab of User Settings.

6.1.3 NESTED PALETTES

Palettes can contain references from other palettes. For example an odd/even colour palette could be created using two other colour palettes as the masters. If you wanted to change the colours, changing the master colour palettes would also change the odd/even colours.

The [Record/Don't Record Nested Palettes] option in the Record Palette menu sets whether nested palettes are recorded (default) or whether the attribute values are recorded instead.

When palettes are used in cues, you can disable the nested palettes using the playback option [Fire/Don't Fire Nested Palettes]. If set to Don't Fire, the nested palettes are treated as the fixed values they held at the time the cue was recorded and won't change if the nested palette is updated.

6.1.4 QUICK RECORD

The palette windows allow you to quickly record a new palette. Just touch the button where you want to record – the button will turn red with a + sign. At this point you can enter a legend for the new palette or change mask settings. A second press on the button will save the palette.



- When using Quick Record, the palette mask is automatically set to match the window - the Position window only stores P, the Colours window only C, and the Gobos and Beams window stores IGBES. This does not happen if you use the <Record> button.

Quick record also works for groups and workspaces.

If you want to load a show from a Pearl Expert onto another Titan console, use the Groups and Palettes workspace window to access the fixtures/palettes on the blue/grey preset buttons on the Pearl. See section 3.2.4 on page 62 for more details.

6.1.5 SETTING LEGENDS FOR PALETTES

You can enter a legend for each palette to tell you what it is. Titan will automatically create helpful legends when you create the palette.

- 1> Press [Set Legend] at the top level menu.
 - 2> Press the palette button for the palette you want to legend.
 - 3> Type the legend on the keyboard.
 - 4> Press <Enter> when you have finished.
- On touch buttons, the palette number is shown top left. The IPCGBES attribute groups contained in the palette are displayed below your legend, so for example Position palettes will show a P, colour palettes a C and so on. In the top right corner is shown G for Global, N for Normal or S for Shared palette.



You can create a picture legend for your palette which could for example represent the colour or gobo it will create. After pressing [Set Legend] and the palette button, press [Picture]. The picture editor will open.

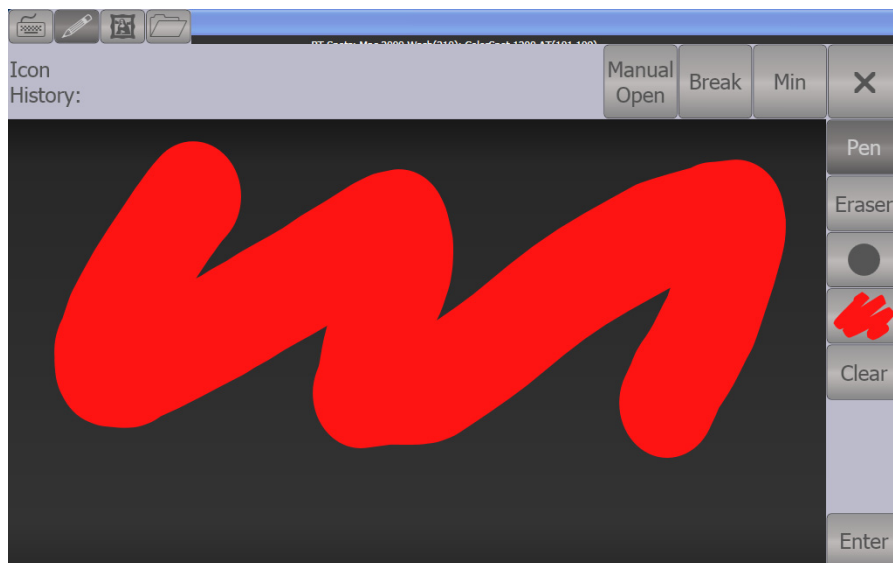

The tab buttons on the top left allow you to select Keyboard entry (legend reverts to text), Draw, Icon Library, or Load File. On the right you can choose Pen or Eraser, set

the pen/eraser size, set the colour (white in the above picture), clear the whole picture, and Enter the legend. The Min button top left reduces the editor to a smaller size.

If you select Library you can choose a picture from a wide range of pre-programmed pictures. The pictures are sorted into various folders which are listed on the left.



6.1.6 CREATING AN EFFECTS PALETTE (SHAPE OR PIXEL MAPPER)

Speed up your programming by creating some palettes which apply shapes or pixel mapping effects. You can't save a keyframe shape to a palette.

For an effects palette to be useful, it needs to contain only effect settings (for example, for a pan/tilt circle you want it to move the fixtures around their current set position, not to change the position as well). To achieve this you can either use the FX mask when saving the palette, or you can just remember not to set any other values when programming.

- 1> Press <Clear>, select some fixtures and locate them. If you need to move them so you can see what's happening, you can do that too.
 - 2> Press [Shapes and Effects], [Shape Generator] and choose a shape to start (see section on page for more information about shapes).
 - 3> Alter the parameters of the shape as you require.
 - 4> Press <Record> then <Palette> (you cannot use Quick Record to store shape/FX palettes).
 - 5> If you moved the fixtures in step 1, press [Set Mask] and exclude everything except FX.
 - 6> Press a palette button to store the shape palette.
- You can't use an effects palette as a "Quick Palette" (when you recall a palette with no fixtures selected). You must have some fixtures selected when you recall an effects palette.

6.1.7 CREATING A TIME PALETTE

You can create palettes which contain only time information. These can be used to set cue times and fixture attribute times without needing to set times manually. Using a time palette also means that you can go back and change the times once in the palette, and the changes will automatically apply to all cues which use the palette.

- 1> Press <Clear>, select some fixtures and locate them. If you need to move them so you can see what's happening, you can do that too.
- 2> Press <Time> (may be labelled Set on Mobile/Sapphire/Quartz, and Next Time on Expert/Tiger).
- 3> Change Fade time to 2 sec. This sets the global fade time into the programmer.
- 4> Press <Record> then <Palette>.
- 5> If you moved the fixtures in step 1, press [Set Mask] and exclude everything except Time.
- 6> Press a palette button to store the Time palette.

6.2 USING PALETTES

6.2.1 RECALLING A PALETTE VALUE

To recall a palette value from a button, this is what you do:

- 1> Select the fixtures to be changed. Shared palettes can be set to any fixture of the same type. Normal palettes will set individual values to each fixture. If no fixtures are selected, the palette will apply to all fixtures it is relevant to.
- 2> Press the Palette button you want to recall. The palette will be set to the selected fixtures.

- You can make palettes fade over a time when you recall them, see section 6.5 below.
- When a palette is used in the programmer, the touch button will light up to indicate this (you can disable this in the User Settings). This makes it easier to see which palette you have selected.



You can also recall a palette by its number by typing the number on the numeric keypad.

- 1> *Select some fixtures.*
- 2> *Press <Palette> above the numeric keypad.*
- 3> *Type in the number of the palette you want to recall.*
- 4> *Press <Enter> or [Apply Palette].*

- The [Apply Palette] softkey shows the legend of the palette which will be applied.
- If you want to recall multiple palettes simultaneously you can use the Blind to Live function. Put the console into Blind mode (either press the <Blind> button if provided, or hold <Avo> and press [Blind Inactive]). Select the palettes you want to use. Enter a fade time in seconds on the keypad (or 0 to snap), then press <Blind> again. The palettes will fade to the live output.

6.2.2 PALETTE PAGES

If you have stored palettes on physical buttons on the console, the <+Page>/<-Page> buttons will change to a different page of palettes. If you want a palette to be locked on its handle and not change when the page is changed, you can set a lock or transparent lock on the palette handle. See section 13.1.11 on page 289 for more details about locks.

Each of the palette windows can either display pages of palettes, with page buttons on the left, or a continuous scrolling window of palettes. To change between pages and scrolling, touch the Pages Show/Hide button in the context button area to the left of the menu buttons. using the page buttons to the left of the palette buttons.

- You can recall a palette from any page using its number as described in the previous section.

6.2.3 ONLY SHOWING RELEVANT PALETTES

If the User Setting [Filter Relevant Palettes] is enabled, when you select fixtures any palettes which are not applicable will grey out. This is very useful to see which palettes are available for the fixtures you are working with.

6.2.4 QUICK PALETTES WITH NO FIXTURES SELECTED

If you press a palette button when no fixtures are selected, the palette will be set to all the fixtures the palette applies to. This is called a Quick Palette. For example if you've got some colour palettes programmed for your MAC 2000's, pressing one of the palettes when no MAC 2000's are selected will set the colour to all the MAC 2000's.

- Effects palettes can't be recalled as Quick Palettes.

6.2.5 SETTING PALETTES TO ALL FIXTURES IN A PLAYBACK

You can apply a palette to all fixtures in a particular playback. Hold the palette button and press the select button of the playback which the palette is to apply to.

6.3 EDITING PALETTES

6.3.1 VIEWING AND EDITING THE CONTENT OF PALETTES

You can view the contents of a palette in the Palette View window. This lists all fixtures in the palette and the attribute values stored for them. A context menu button allows you to switch to displaying Times.

Press <View/Open>, then the button of the palette. The Palette View window will open.

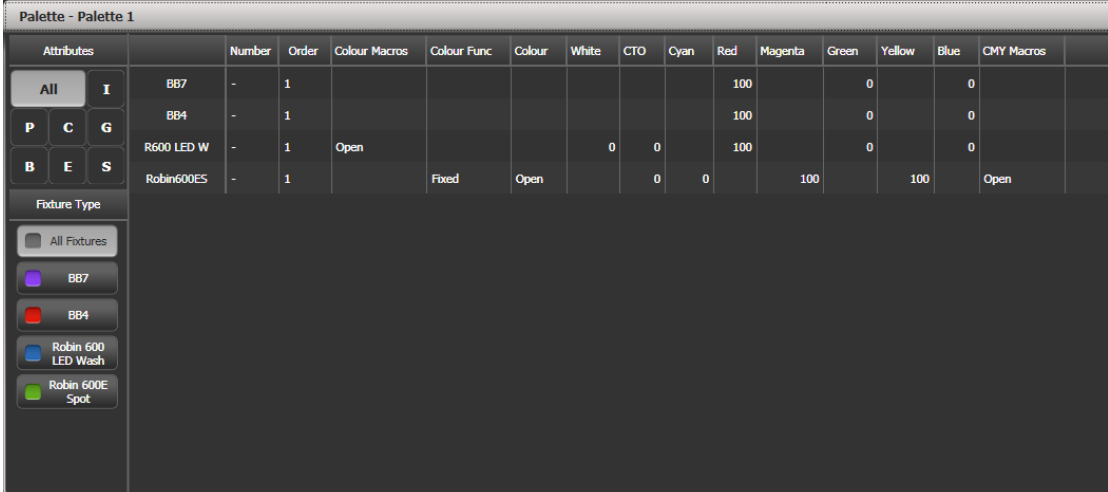

Attributes	Number	Order	Colour Macros	Colour Func	Colour	White	CTO	Cyan	Red	Magenta	Green	Yellow	Blue	CMY Macros
All	BB7	-	1						100		0		0	
	BB4	-	1						100		0		0	
P	R600 LED W	-	1	Open		0	0		100		0		0	
B	Robin600ES	-	1		Fixed	Open		0	0		100		100	Open

You can filter which attributes are shown using the All/PCGBES buttons in the top corner, or which fixtures are shown using the fixture type buttons below that.

To edit an attribute value, touch/click on it in the window. The softkeys will give you a list of available settings for this attribute or you can type in a numerical value.

There is also a [Delete] button which allows you to remove the value from the attribute. This is the same as using the Off function.

- When the palette contains other palettes, the context menu option [View/Hide Nested Palettes] sets whether or not the view shows the actual attribute value or just the name of the nested palette.
- When the palette contains shapes, the context menu option [View Shapes] will open the Shape View showing all the shapes with their parameter. Clicking View will open the Shape Fixture View which lets you edit the fixtures running the shape; the Add Fixtures menu button will add selected fixtures into the shape.
- When the palette contains effects (Pixel Mapper) the context menu option [View Effects] will open the Effect View window to let you edit the effect.

6.3.2 CHANGING THE CONTENT OF PALETTES

To edit a palette entry, press <Edit> (<Update Palette> on Pearl Expert and Tiger Touch mk1), then select the palette to edit. For Normal palettes this will automatically select the fixtures used in the palette; for Shared palettes the first fixture in the palette will be selected. Next, make the changes you want, then press the [Update Palette x] softkey to save the changes.

The <Edit>/<Update Palette> button also allows you to change the palette name and number.

You can also load the palette into some fixtures, modify the attributes and record the new information back on top of the existing palette entry. The console will give you options on the softkeys to Replace, Merge or Quick Merge the palettes. If you select Merge, anything you haven't changed will not be affected, values you have changed or added will be amended. Quick Merge will only update the attributes stored in the original palette and ignore others (for example if you are merging with a position palette, but have also modified the colour attributes, the colour attributes would not be merged in).

When double clicking a palette button to update, the default option is Quick Merge.

- You can set the console to “Always Merge” (so it doesn't ask you) using the User Settings (hold down the <Avo> button to set these). You can also press the palette button a second time to select the Merge option.
- You can add additional fixtures to a palette without affecting existing ones. For example, if you have colour palettes for Mac 600s, you can add colours for your Mac 500s without affecting any previously recorded values in the palette.
- You can remove attributes from palettes using the Off function, see section 8.4.5 on page 212.
- When editing a palette the state of the programmer will be preserved; when the modified palette is saved, your original programmer contents will be restored and the programmer will be left in the same state as when you started editing the palette.

6.3.3 UPDATING PALETTES USED IN A PLAYBACK

If you need to quickly update a palette during a show, for example you fire a green cue and the Green palette used turns out to be not quite the right colour, the Update function lets you automatically update the palette used in the cue.

- 1> *With the cue fired, select the fixtures and change them to the settings you want to store (e.g. the right green colour).*
- 2> *Press <Update> (on Pearl Expert, <Record Cue>, [Update]).*
- 3> *The cues and palettes which relate to the cue and can be updated are shown on the softkeys.*
- 4> *Select the items you want to update and press <Update> again.*

6.4 COPYING, MOVING AND DELETING PALETTES

6.4.1 COPYING OR MOVING A PALETTE

Using the <Copy> button you can make a copy of an existing palette or move it to a new button. You can copy or move multiple palettes in one operation. You cannot link palette buttons.

Move is useful for tidying up the console.

- 1> Press <Copy>.
 - 2> Select [Copy] or [Move]. Pressing the <Copy> button again will also toggle these options. Some consoles have a <Move> button.
 - 3> Press the Select button of the palette you want to copy/move. You can select multiple palettes – use the <Thro> and <And> buttons to add more to the selection – hold down <And> to keep adding them..
 - 4> Press the empty button where you want it to go.
- The <Menu Latch> button latches the Copy/Move/Link menu, so you can keep copying, moving or linking things without having to keep pressing <Copy>. Press <Menu Latch> again to unlatch.
 - [Retain Layout] or [Bunch Up] is used when copying a group of palettes with empty handles in the group – you can either keep the empty handles, or bunch up the used handles together.
 - When in Copy mode, option [Copy Legends] can be changed to [Don't copy legends] so that the copied palettes are given default legends.
 - When in Move mode, [Swap Items if Required] will attempt to reposition any existing handles which are in the way of the move. This is useful when rearranging buttons on a page which is nearly full.

6.4.2 DELETING PALETTES

You can delete a palette entry by pressing <Delete>, then pressing the palette select button to be deleted. Press the palette button again to confirm the deletion. For palettes stored on physical buttons you can delete a range of palettes in one go by holding down the first one while pressing the last one.

Other ways to delete a palette:

- If the console has an <Update Palette> button, press it, then select a palette, then use the [Delete] softkey option.
- Press the <Palette> button above the numeric keypad and use the [Delete] option in the [Palette Utilities] menu.
- Press <Delete> then [Palette], type the palette number, press <Enter>.
- If you have playbacks which use the deleted palette, they will go back to the values which were stored in the programmer when the playback was recorded.

6.5 TIMING WITH PALETTES

Palettes may be saved with timing information, or you can manually override the timing when recalling the palette.

6.5.1 PALETTES WITH SAVED TIMES

If you have saved time information in a palette, it will normally recall with this timing information. So if you programmed a 2 second fade, the palette will recall with a 2 second fade.

You can turn this off (which can be useful during programming) using the key profile setting for palette keys (see section 16.3.1 on page 322). You can set [Palette Is Fired With Its Times] or [Palette Is Fired Ignoring Its Times].

6.5.2 MANUALLY OVERRIDING PALETTE TIMES

Being able to recall palettes with a manual fade allows easy "busking" of shows. When a palette is recalled in this way, a time is added and the palette fades in over that time.

- 1> *Select some fixtures.*
- 2> *Type in the fade time for the palette on the numeric keypad.*
- 3> *Press a palette button to recall the palette.*

- This overrides any timing stored in the palette itself.
- You have to re-enter the time each time you recall a palette. To use the same fade every time, set a Master Time: Press Palette, [Master Time]. To disable Master Time set to 0.
- Palette fading can be very useful when recalling a palette live during a show, as you can smoothly move fixtures to a new position or change colour slowly (on colour mixing fixtures).

6.5.3 MANUAL FIXTURE OVERLAP WHEN RECALLING PALETTES

You can set a Fixture Overlap when recalling a palette, which means that the palette will be applied in sequence to each fixture in the group. This is a very quick way to busk some amazing effects. Fixture Overlap=100% means that all fixtures will change together. Fixture Overlap=0% means that each fixture must complete its fade before the next will start its fade.

- 1> *Type in the overlap time for the palette on the numeric keypad.*
- 2> *Press [Set Overlap].*
- 3> *Type in the fade time if fade is also required.*
- 4> *Press a palette button to recall the palette.*

- You have to re-enter the overlap each time you recall a palette. To use the same overlap every time, set a Master Overlap: Press Palette, [Master Overlap]. To disable Master Overlap set to 100%.

6.5.4 MASTER TIME FOR PALETTES

Option [Master Time] on the Palette menu (press the <Palette> button above the numeric keypad) allows you to set a default fade time. This fade time will be used for all palettes unless you manually type in a different time. This can be useful when "busking" a show with palettes.

The [Master Overlap] option similarly sets the default Overlap for palette recall.



You can create macro buttons to set different palette fade times. Press <Macro>, [Record], press a button to store your macro on. Then press <Palette>, [Master Time], 3 (for 3 sec), <Exit>, <Macro>. Repeat these steps to create a Palette Snap button (0 sec), or a 1 sec fade button,

and so on.

7. SHAPES AND PIXEL MAPPER EFFECTS

The Shape Generator in Titan (sometimes known as an Effects Generator on other consoles) allows you to quickly create exciting light shows using lots of movement and changes, with the minimum of programming. A range of speed controls allow you to modify how the shapes appear at showtime giving you a whole range of effects from a few basic stored cues.

You can use the conventional Shape Generator with preset patterns, or the Key frame Shape Generator which allows you to create your own custom patterns.

The Pixel Mapper is used to generate animated textures using the colour or intensity of a group of fixtures (often LED battens, starcloths or LED web type fixtures). When viewed at a distance the effect becomes clearly visible.

7.1 SHAPE GENERATOR

A shape is simply an automatic sequence of values which modify a particular attribute of a fixture. A circle shape, for example, applied to the pan and tilt attributes, would cause the fixture to move its beam in a circular pattern around its current position. You can set the size of the circle and the speed of the circle movement.

In addition to position shapes, there are a large number of other shapes available in Titan. The shapes are defined for a particular attribute such as colour, dimmer, focus and so on.

A further category of shapes is the Block Shape. This type of shape blocks out other shapes, preventing them from running. For example, if some fixtures are running a Circle shape, and then a playback is fired which has a Block Pan/Tilt shape on some of the fixtures, those fixtures will stop running the circle shape. This can be very useful to modify playbacks at showtime when used with the playback priority feature (see section 8.7.1 on page 220).

When you use a shape with more than one fixture, you can choose to either apply the shape identically to all the fixtures, or offset them so that the shape runs along the fixtures creating “wave” or “ballyhoo” type effects. This is called the *Phase* of the shape.

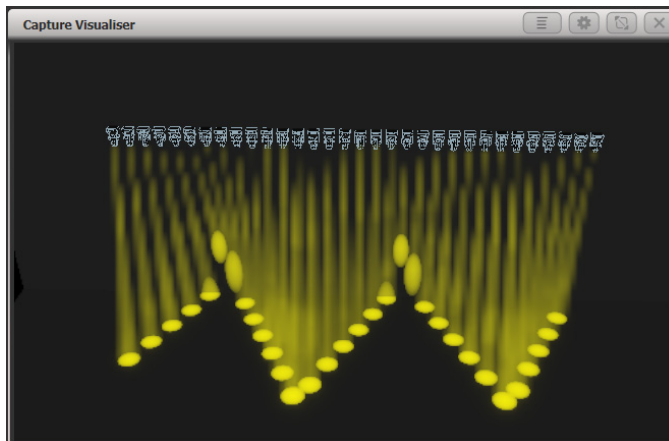

7.1.1 SELECTING A SHAPE

To run a shape, select some fixtures, pick the attribute of the shape from a list on the softkeys, then choose the shape you want from the Shapes window. Shapes are organised using the IPCGBES attribute groups, so you can pick from a list of Dimmer shapes, or a list of Pan/Tilt shapes, or Colour shapes, and so on. You can also pick from a list of All Shapes.



When you create a shape, it will be applied to all selected fixtures.

- 1> *Select the fixtures the shape is to be applied to.*
 - 2> *At the main menu press [Shapes and Effects] then [Shape Generator].*
 - 3> *Press [Create] to start a new shape.*
 - 4> *Press a softkey to select the attribute type to use in the shape or press [All shapes] for a full list.*
 - 5> *Press a softkey to select a shape, or touch the desired shape in the Shapes window. You can type a search word on the keyboard to search for a particular shape.*
 - 6> *The shape will be applied to all selected fixtures.*
- If you open the Shapes window, it will remain open for instant selection of shapes (you don't need to select [Shape Generator]). The window will only show shapes which are possible on the selected fixtures. Pressing attribute buttons will filter the Shapes window to show only shapes for that attribute. Press the <Dimmer> attribute button to show all shapes.

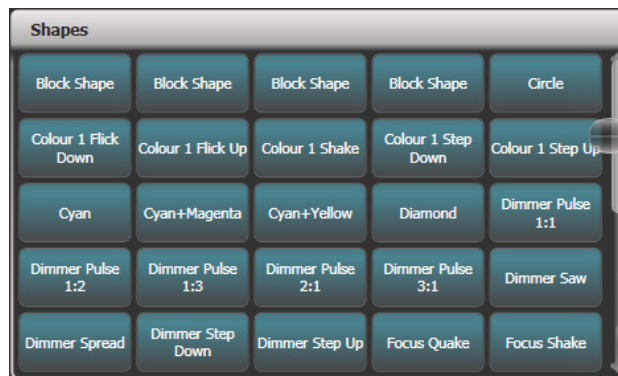

- Shapes are based on the current settings of the fixture, so a position circle would move around the current pan-tilt position of the fixture.
- You can change the base value of a shape (e.g. the centre of a circle) by changing the attributes using the wheels in the usual way. You can reduce the Size to zero (see next section) to help you see what the base value actually is.
- You can run more than one shape at a time by repeating the above procedure. You can run several shapes on one fixture and the output will combine in interesting ways.
- Press [Shapes and Effects], [Shape Generator] then [Edit] to show what shapes are running.
- If you apply the same shape to two different groups of fixtures, the shape will appear twice on the shape list. You can edit the two shapes separately to give different directions, speeds etc (see later)
- If the selected fixture has subfixtures (cells) then you will be given the option to run the shape on the main fixture, keeping all cells identical, or spread across the subfixtures/cells. The options are
Run on Super Fixtures: cells are ignored, fixture operates as one block
Run on Sub Fixtures (Linear): the cells are used in numerical order
Run on Sub Fixtures (Group): the layout of the cells is used as programmed in the Layout Editor for the group.
- Each shape is designed to work on a particular attribute. Obviously if the fixtures don't have the attribute, you will not see any effect if you use the shape.
- Each shape has a default size and speed setting (defined in the shape file).



When using a Rainbow colour shape, to get the full range of colours you need to set the CMY or RGB attributes to 50%.

7.1.2 CHANGING SIZE AND SPEED OF A SHAPE

It is easy to change the size and speed of a shape after it has first been created. If the display above the wheels is showing Spread and Offset rather than Size/Speed, press [Adjust Speed, Size and Spread].

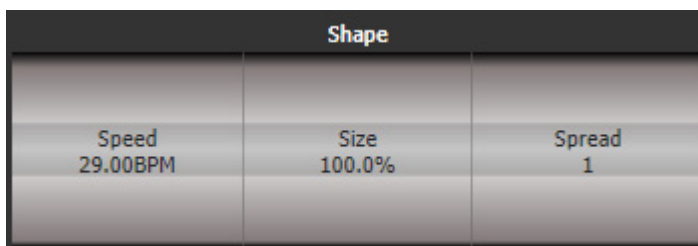

- 1> Control the speed of the shape using the left hand wheel.
- 2> Control the size of the shape using the middle wheel (right hand wheel on Pearl Expert).
- 3> The size and speed is shown above the wheels on the display.

Other things to know about size and speed of shapes:

- If you have more than one shape running, the controls operate on the most recent one. You can edit the parameters of any shape that's running using the Edit Shape function, see section 7.4.1.
- The minimum size is zero. This will "hide" the shape, and the fixture will resume its previous settings. The shape is, however, still active.
- Once a shape is saved in a playback, you can use the playback fader or a separate Speed or Size master to control the speed and size. See 13.1.4 on page 284. for more details.

7.1.3 CHANGING THE SPREAD OF A SHAPE ACROSS MULTIPLE FIXTURES

Shapes get more interesting (and look more impressive) when you apply them to multiple fixtures. You can control how a shape is spread across several fixtures. You can also control Phase, which is a different way of selecting the same thing.

The sequence of the shape across the fixtures is controlled by the order in which you selected the fixtures when you created the shape. You can edit the order by selecting [Fixture Order] in the Shape Edit menu.

- 1> If the right hand wheel isn't showing Spread, press [Adjust Speed, Size and Spread].
- 2> Control the Spread of the shape using the right hand wheel, or to set in terms of Spread, press [Adjust Spread, Phase and Offset] and use the middle wheel (right hand wheel on Pearl Expert).

Spread=12 (Phase=30 degrees)

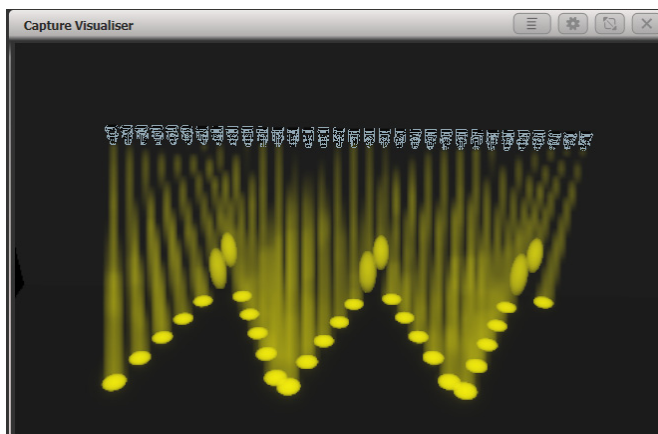

Spread=6 (Phase=60 degrees)

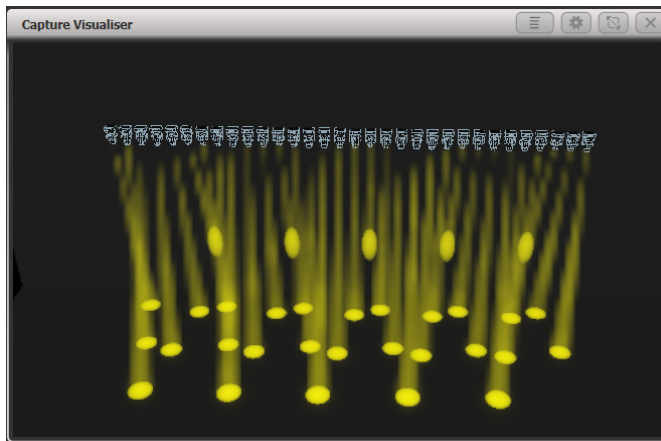

Spread=2 (Phase=180 degrees)

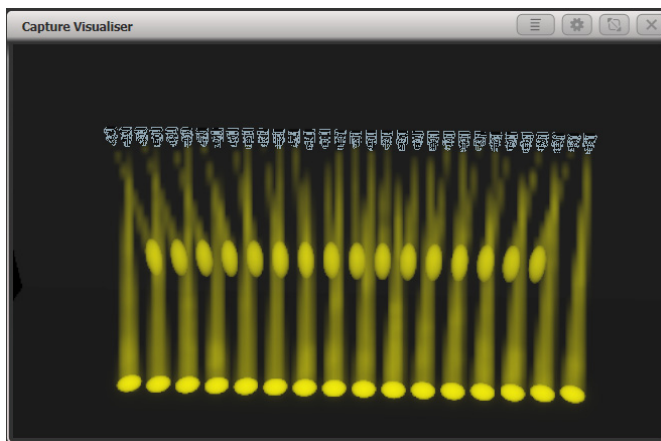

In Phase mode, the display above the wheel shows the phase in degrees. For example, 180 degrees repeats every 2 fixtures, 90 degrees repeats every 4 fixtures, 60 degrees repeats every 6 fixtures, and so on.

The Offset function allows you to set the starting phase of the shape, when more than one shape is running. For example, if you were running a Cyan shape and a Magenta shape to create a mix of colours, you would probably want to start them with Cyan at full and Magenta at zero to give the full range of colours. In this case you would set one of the shapes to have a Phase Offset of 180 degrees. Without the phase offset, both shapes would reach full at the same time.

7.1.4 SHAPE DIRECTION

The [Direction] softkey opens a menu allowing you to set a direction for the shape. If you have defined a 2D layout for the group (see section 5.3.2 on page 135) this allows you to have shapes that visibly move in particular directions.

You can keep the shape direction menu open using the <Menu Latch> button, to allow you to try different options and see the effects.

7.1.5 BEAT AND CYCLES

The [Adjust Beat and Cycles] option lets you set on the wheels how the programmed speed will trigger the shape, and how many times the shape will run.

BEATS

The Beats option defaults to [Beats=1] which makes the shape run at normal speed. Higher numbers will divide the count, for example [Beats=4] will make the shape run at quarter of the speed. This is really useful to synchronise different types of shapes which are running together.

Clicking the middle of the wheel roller image on screen or pressing @ for Wheel A allows you to type in a number for the Beats parameter, and also shows two further options for Beats: [Match to Spread] sets the beat count to be the same as the current Spread setting for the shape. This is useful when using dimmer shapes with movement shapes as it will make each fixture turn on for a full cycle of the movement shape. The [Custom] option resets the [Value] option to the last entered value.

CYCLES

The cycles option sets how many times the shape will run. By default this is set to infinity (∞) which means the shape will continue to run until you stop it. If you set a fixed number, the shape will stop by itself after that number of cycles.

You can type in a number instead of using the wheels by clicking the middle of the wheel roller image on screen or pressing @ for Wheel B. If you are typing in a number you can enter part cycles, for example 1.5.

7.1.6 USING SHAPES IN CUES

When you save a shape into a cue, you can set the playback fader to control the size and/or speed of the shape to give you more options at show time; you can also control the size and speed from separate Size Master and Speed Master faders. See section 13.1.4 on page 284..

You can use shapes in a cue list and section 10.1.3 on page 239 describes how the shapes will behave as you go from cue to cue.

You can also adjust parameters of the shape at playback time using the Select Shape menu, which is on the [Edit] menu of the Shape Generator menu.

7.1.7 STORING SHAPES IN PALETTES

You can create palettes containing shapes. This is really useful to quickly call back shapes pre-configured with different spread and speed settings. See section 6.1.6 on page 146.

7.2 KEY FRAME SHAPES

Key frame shapes allow you to create your own shape sequences. You store a series of attribute settings as key frames and the shape fades between them.

7.2.1 CREATING A KEY FRAME SHAPE

A key frame shape is created a bit like a chase, but the shape is more flexible because you have lots of control over the way the attribute changes between key frames, and you can change the way it spreads across multiple fixtures. It's also (unlike chases) easy to save in cue lists.

You can create the key frames either in Channel Mode by manually setting up a state and pressing [Add Frame], or in Quick Build mode by selecting palettes or cues which will be automatically saved as a frame as you select them. Use the [Record Mode] softkey to select the mode.

In this example we'll create a colour shape, but you can create key frame shapes for any attribute or mixture of attributes. If you create key frames using palettes, the key frames will update if the palette is changed.

- 1> At the main menu press [Shapes and Effects] then [Key Frame Shapes].
- 2> Press [Create] to start a new shape.
- 3> Select fixtures and set the colours for the first key frame.
- 4> Press [Add Frame]. An automatic legend for the first key frame will show above the first playback fader. (Press [Playbacks Display Visible/Hidden] to return the playback faders to normal, if you want to select one in Quick Build mode).

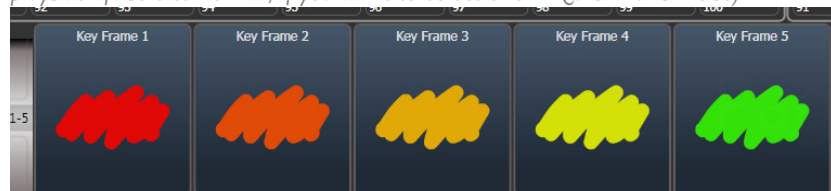

- 5> Continue to set colours and press [Add Frame] until you have created all the steps you want.
- 6> Press [Finish Recording Frames] when you've finished.
- 7> Use the Effect Editor window to change the Spread, Overlap (see below)
- 8> Save the shape to a cue if you want to use it in a show (see section 8 on page 197).

- You can also use the <Unfold> button to switch the playbacks between normal mode and key frame display mode.
- Setting the [Frame Number] softkey to an existing frame number allows you to [Replace] or [Delete] a frame. Clicking the frame legend or the select button of the playback will also set the current frame number.
- If the shape is not visible because fixtures are not lit up, the locate dimmer “sun” button at the bottom will light up fixtures used in the shape.

7.2.2 CHANGING SHAPE PARAMETERS IN THE EFFECT EDITOR

Once you have finished creating a key frame shape it will be shown in the Effect Editor window.

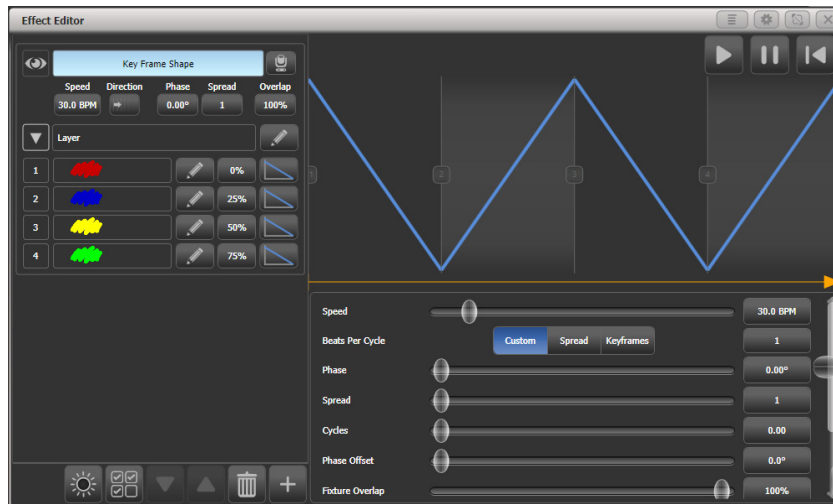

The controls at the top of the left hand pane are the global shape properties which affect the whole shape, controlling speed, direction (using 2D group layout), phase/spread and fixture overlap.

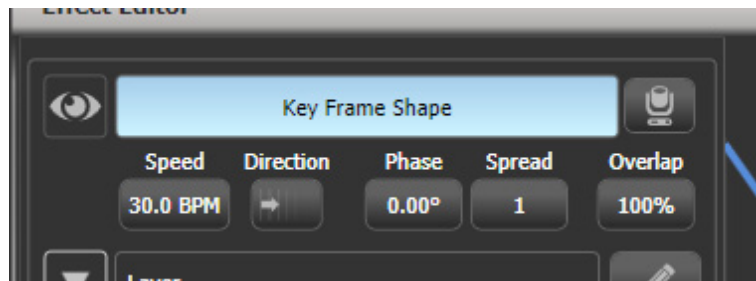

The eye icon in the top left corner “collapses” the shape preview in the effect editor window, this allows you to expand only the shape you want to work on if you have created multiple shapes. The fixture icon button on the right opens the Visualiser window.

The top of the main area shows a graphical version of the fades in the shape, which you can drag around to change the timings. The yellow arrow shows the phase offset (start position) for the layer, you can drag this to change the start point of the shape relative to other layers (or use the Phase Offset slider below).

To start with (or when you click on the Layer name) the sliders to the right of the main area are independent controls for the layer.

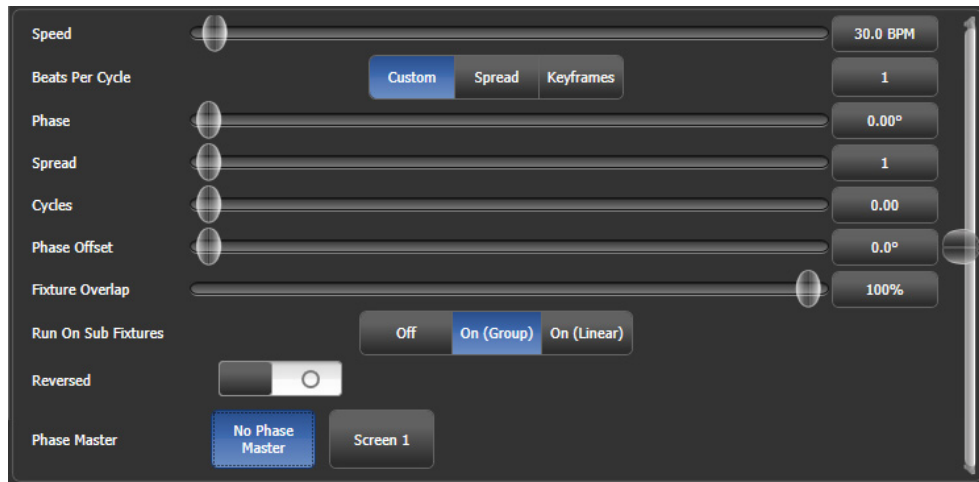

You can click on the buttons to the right of the sliders to enter values from the keyboard, and when the button is clicked on the wheels can also be used to adjust the value. A [Reset to default value] softkey is also provided when you click the buttons, or double-clicking the buttons will reset to default value.

The Beats per Cycle control lets you set how the programmed speed will trigger the shape. It defaults to 1 which makes the shape run at normal speed. Higher numbers will divide the count, for example 4 will make the shape run at quarter of the speed - useful to synchronise different types of shapes which are running together. [Spread] sets the beat count to be the same as the current Spread setting for the shape. This is useful when using dimmer shapes with movement shapes as it will make each fixture turn on for a full cycle of the movement shape. [Keyframe] sets the beat count to match the number of keyframes in the shape. The [Custom] option resets the [Value] option to the last entered value. Each keyframe and each layer can have its own Beats per Cycle setting.

The Cycles option lets you create a shape which runs for a set number of cycles then stops. By default this is set to 0, which means the shape will not stop. You can set this either for the whole shape, or for individual layers – if you set it while the whole shape is selected, then all layers will be affected, but if you set it while only one layer is selected, then the cycles will be set for the selected layer only. This means you can have individual layers running continuously or for different numbers of cycles.

Keyframe shapes can run across sub fixtures (cells). This is turned Off by default, but you can select On (Group) which uses the Direction setting with the layout set for the group, or On (Linear) which ignores the layout and just uses the cells in numerical order.

The Phase Master option lets you control the phase of the shape using the intensity of a video layer from an Ai server. See section 12.2.6 on page 281 for more details.

PARAMETERS FOR INDIVIDUAL FRAMES

By clicking on individual key frames on the left, you can change parameters for each individual frame.

- Timing: use the Start Time slider or drag the step positions in the window.
- Frame A Min / Frame B Max: Sets how close the attribute gets to the programmed value. For example if you've saved a dimmer flash at 100% you could make it only flash to 80%.

- Mid point: sets where the mid point of the fade is
- Width: sets how much of the frame time is taken up by the fade. For example you could fade in 20% of the frame time then hold for the remaining 80%.

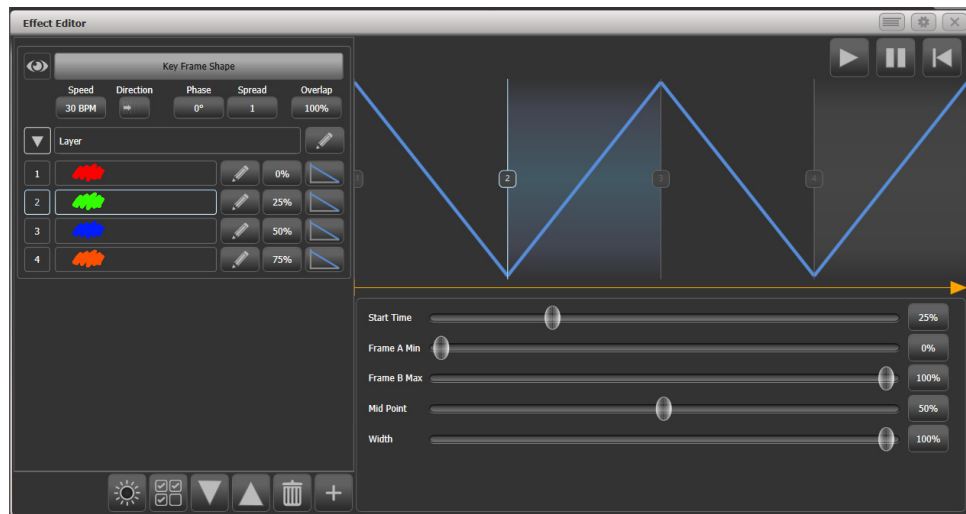

You can change the style of the change between steps by clicking the curve button to the right of each step. The new curve will be shown in the fade graphic in the main window.



You can also edit the sequence of the key frame shape using the Effect Editor window.



- To add more frames to a key frame shape click the pencil button to the right of the layer name.
- To edit a key frame click the pencil button to the right of the frame name.
- To delete a key frame select the frame in the list then click the rubbish bin icon at the bottom
- To change the order of the frames, select a frame then use the up and down arrows at the bottom.
- To change multiple key frames at the same time, click on the multi-select button at the bottom of the window, or you can drag a selection box over the frames.

Key frame shapes can have multiple layers where different effects run simultaneously. To add another layer, click the plus button at the bottom, then select Layers. The new layer will appear in the list on the left.

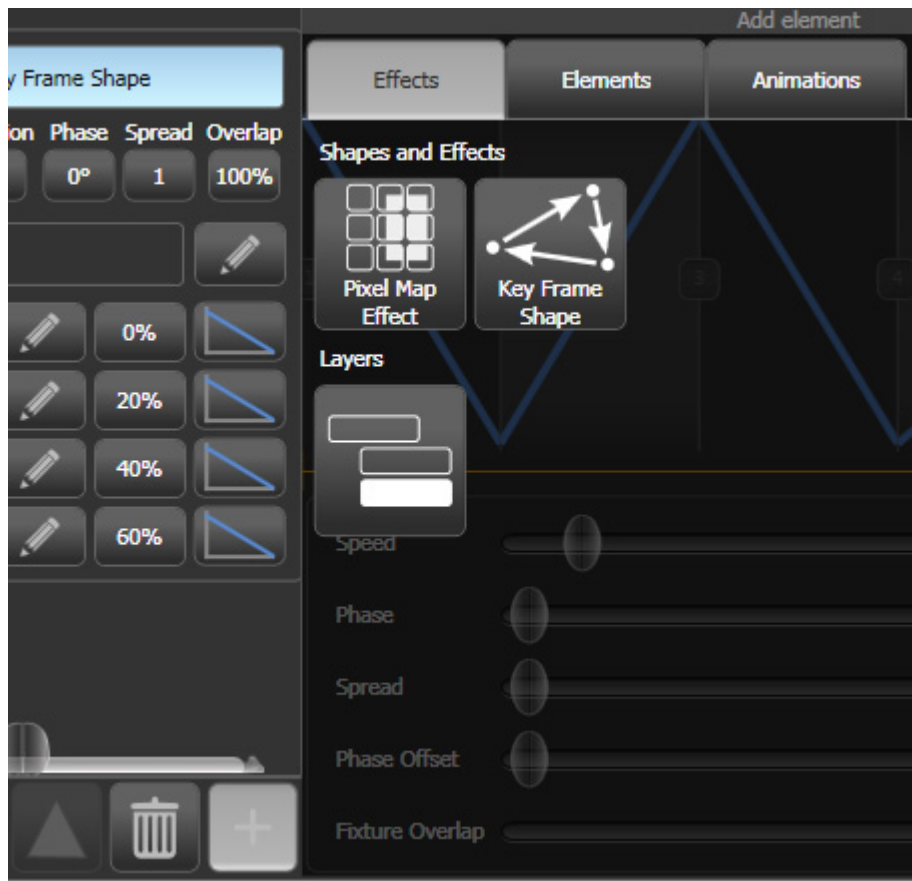

You can also add a completely separate key frame shape or a pixel map effect. Pixel map effects will be shown at the top of the shape list on the left, you can use the eye icon to hide the pixel map effect when you want to work on the key frame shapes.

7.2.3 SAVING A KEY FRAME SHAPE TO A CUE

By default when a key frame shape is saved to a cue, the playback fader will fade the shape. If the playback is set to have Speed on Fader, the fader will master the speed of all layers in the shape.

When a key frame shape is running in a playback it can behave as Overlay or LTP. A global value for Shape Behaviour is in the User Settings, but you can also set the mode in Playback Options for each playback.

- In Overlay mode (default) the shape will have control of the programmed attributes regardless of whatever else you do. For example if a key frame shape is controlling fixture colour, firing another playback, recalling palettes or changing colour using the wheels will have no visible effect. Once the shape is stopped, the changes you made will become visible. This means that if you want to you can preset what will happen when you stop the shape.
- In LTP mode, changes of the same or higher priority will override the shape output. For example if your key frame shape is set to normal priority, firing a playback with normal priority will block the shape output. Killing the playback will restore the shape output. Quick Palettes and manual changes (the programmer) have High priority. Setting the shape priority to “Very High” would prevent the programmer taking over (see section 8.7.1 on page 220 for how to set priority).

For details of how Key Frame Shapes behave in Cue Lists, see 10.1.3 on page 239.

7.3 PIXEL MAPPER

7.3.1 CREATING PIXEL MAPPER EFFECTS

The Pixel Mapper works on a group of fixtures, which you have set up using the Fixture Layout function. This tells the console where the fixtures are physically located on the stage. The console then maps the fixtures as pixels and uses them to output a 2D effect. See section 5.3.2 on page 135 for details of how to layout the fixtures.



At the end of this section (Section 7.6 on page 175) there are a number of step-by-step examples of creating effects with the pixel mapper. It's much easier to get to grips with if you can work through some examples.

You create effects with the Pixel Mapper as follows.

- 1> Select the group of fixtures.
- 2> From the top level menu select [Shapes and Effects] then [Pixel Mapper]
- 3> Select [Create effect]. The Pixel Mapper Editor will open with a blank background. You can overlay your fixture layout on the window, to help you see where your fixtures are, by clicking on the [Fixture Overlay 50/50] context menu button.

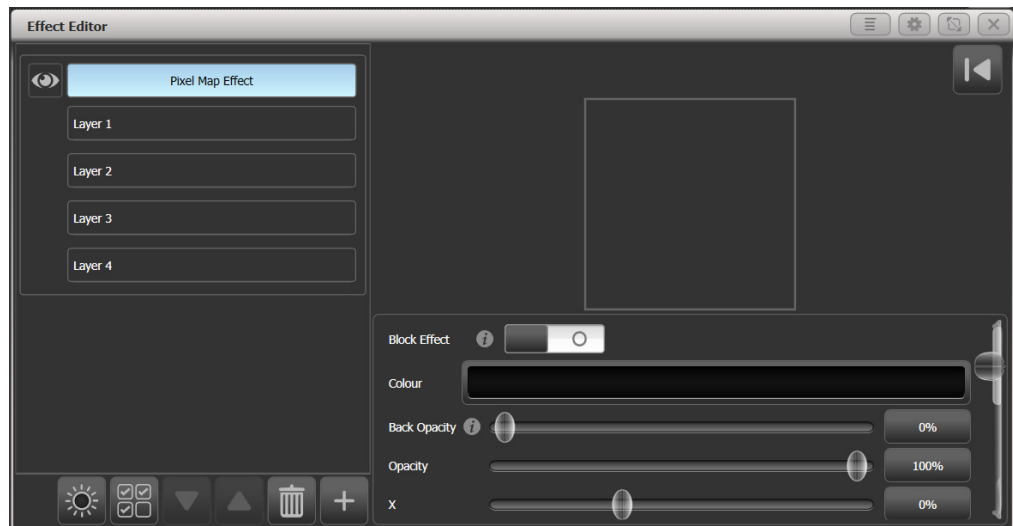

Click on the + button at the bottom to add an effect, and choose a graphic element. You can remove elements by selecting them and clicking on the “rubbish bin” icon. The graphic buttons as shown below provide the following effects:

- Square
- Circle
- Triangle
- Star
- Fan
- Spiral

- Text
- Scribble (you draw an image on the touch screen)
- Image/bitmap (loaded from disk)
- Ai media server content

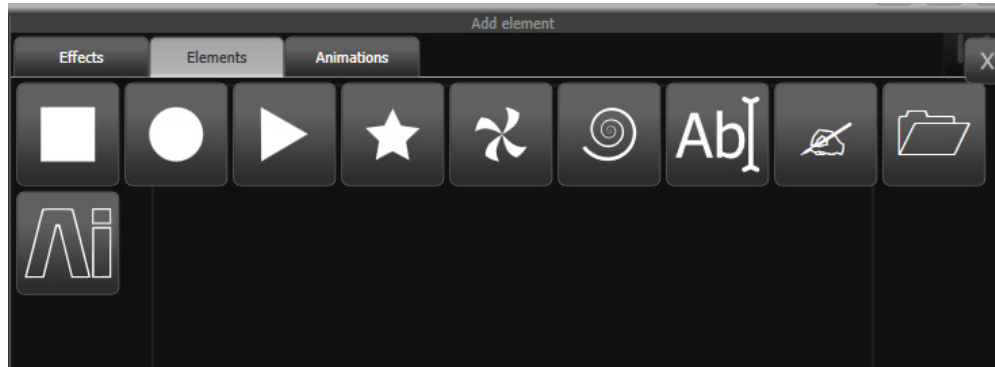

The graphic element will appear in the top part of the window and will be output to the fixtures. You can change it using the sliders below, which will vary depending on the shape but may include:

- Opacity
 - X, Y position
 - Width, height
 - Zoom
 - Rotation
 - Border width
- (To change the colour, click on the layer name)

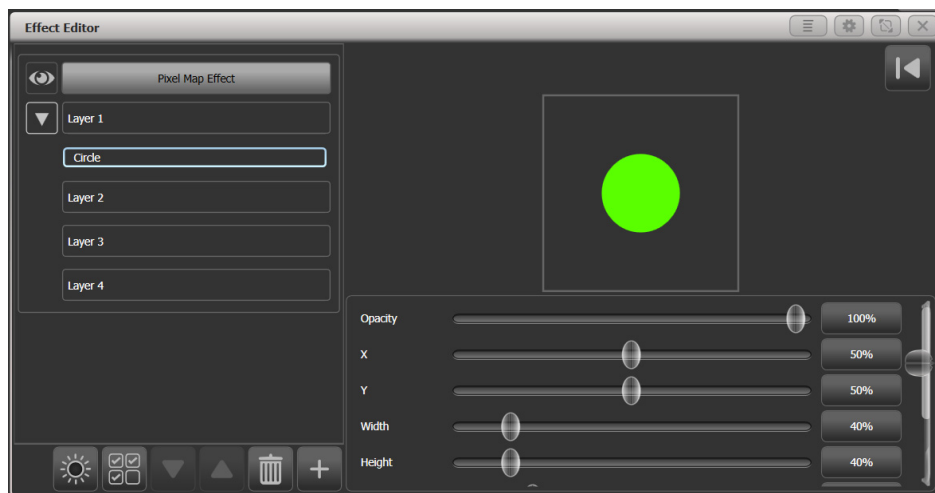

Then with the graphic element selected on the left hand side, click on the + button again and choose an animation (how your graphic element will move or change). The animated effect will show in the black window and be output to the fixtures You can add multiple animations which will combine to give the overall effect.

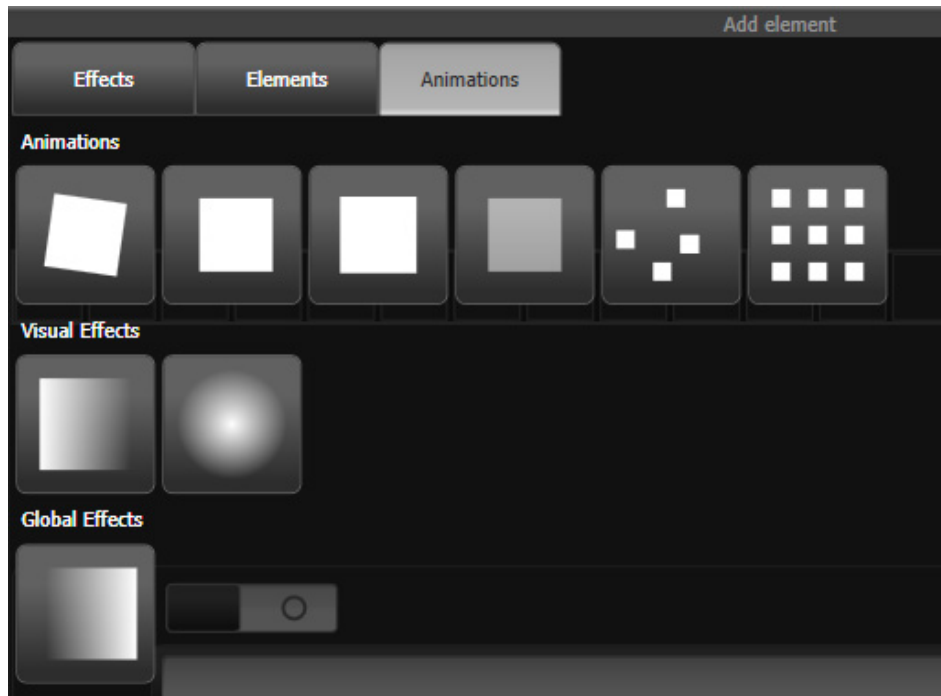

Available animations are:

- Rotate
- Slide
- Zoom
- Opacity/Fade
- Random
- Grid Fit (elements will accurately align with the pixel grid)
- Linear gradient
- Radial gradient
- Motion blur (adds a trail to objects)

The animation will move or transform the element. It can also “spawn” or create new copies of the element.

You can edit what the animation does by selecting the name on the left hand side. Sliders are provided to configure the animation, the sliders may vary depending on the particular effect but may include

Speed (speed of the movement)

Speed Random (adds a random factor to the speed of each element)

Spawn Rate (sets the rate at which new elements are created)

Spawn Random (adds a random factor to the spawn rate)

Spawn For (sets how many elements will be spawned, after this no more will appear)

Run For / And Then (for each element, sets how many cycles it runs for, and what happens to it after that – freeze or kill)

Direction / Direction Random (for movement effects only)

Start Angle / End Angle (for rotation effects only)

- For Grid Fit you need to specify the number of rows and columns in the grid.

- For the gradient animations you set the start and end opacity and the offset between them; you also set the Spread which can be Pad (single gradient), Reflect (repeats the gradient in and out) or Repeat (snaps back to start then repeats the gradient fade)
- If you specify Spawn For or Run For, the simulation will stop after the specified number of cycles. To restart the simulation, click the reset button on the top right of the Effect Editor window.

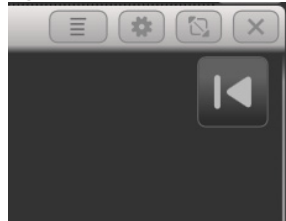

- For an effect with a start point and end point, the number of cycles is the number of times it goes between the start and end points. For an effect with no end point the number of cycles is based on the master clock and animation speed.

If you don't have fixtures connected, you can see how the effect will look on the fixtures using the Pixel Mapper preview window – open it by pressing <View/Open>, [Open Workspace Window], [Pixel Mapper Preview]. A real life view of each effect currently running is shown in a button at the bottom of the screen, you can select each of these by pressing the button.

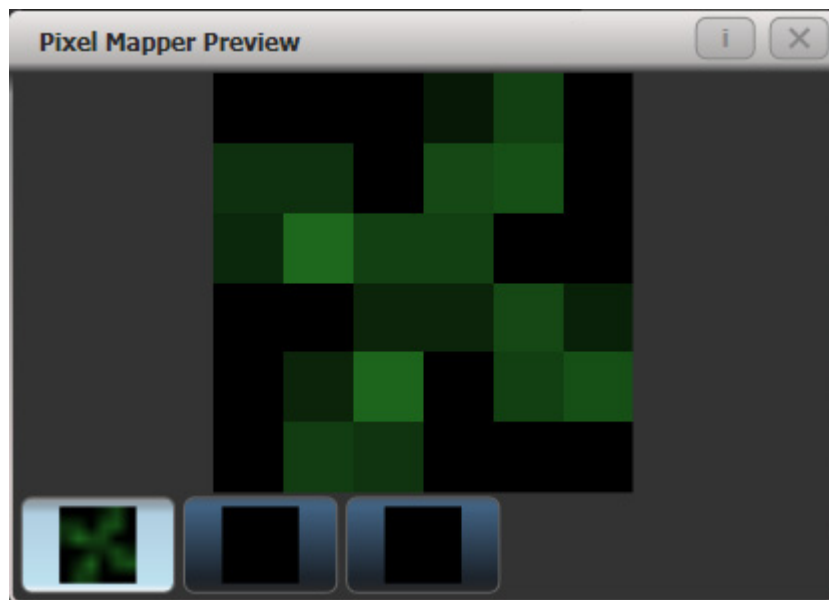

If you wish you can overlay further layers on the effect. Once you have an effect you like, you can save it to a playback.

When adjusting the parameter sliders, as well as using click/drag on the screen you can also use the wheels or type in a numerical value. To assign a slider to the

wheels or for numerical input, click the value box to the right of the control. Double click the value to reset it to its default, or use the +/- softkey to change the sign of the value.

- You can reorder the Pixel Mapper layers by selecting the layer to move and clicking on the up/down arrow buttons.
- You can copy or move layers, elements and animations by pressing Copy or Move, then select an element, then select a destination to copy or move it to.

Each effect you create also has master parameters which affect how it will combine with other effects. Click on the effect name top left to set these parameters:



- The Block Effect switch allows you to create a pixel map effect which will block out any pixel maps running on the selected fixtures (according to the priority setting). This lets you create a cue which will temporarily stop a pixel map effect (similar to Block Shapes).
- Colour sets the background colour of the effect (Will have no effect if Back Opacity is 0)
- Back Opacity sets whether other effects will show through in the background of this effect. By default this is 0, so other effects will show through.
- Opacity sets how much other effects show through the foreground of this effect.
- X/Y/Zoom/Rotation let you modify the position and size of the effect
- Master speed sets the overall speed of the effect, this controls animation speeds and cycle counts
- Pre-spool makes the effect start mid-flow as if it has already been running for a time. This lets you start slow-building effects in their full glory.

- Run For / And Then sets how many cycles the effect will run for, and what will happen at the end (Freeze, Kill or Stop Spawning). Run For defaults to “Forever”.

7.3.2 PIXEL MAPPER LAYER MASTERS

You can assign each of the four layers to a master. The master allows you to adjust the layer controls in real time. When the master is assigned to a fader handle using the [Assign Masters] [Pixel Mapper] controls, the fader will control opacity of the layer.

This means you can create cues and palettes which can manipulate the layer settings of effects which are running in other cues.

To enable the layer master, turn on the Use Master switch in the effect editor window.

- Layer masters may require an updated personality file.

7.4 EDITING SHAPES AND EFFECTS

7.4.1 EDITING A LIVE RUNNING SHAPE

You can change the speed, size and spread of a live running shape by pressing <Connect> then <Shape> (which will flash if any shapes are active). The softkeys will show a list of the currently running shapes, and the cue they are coming from or the programmer.

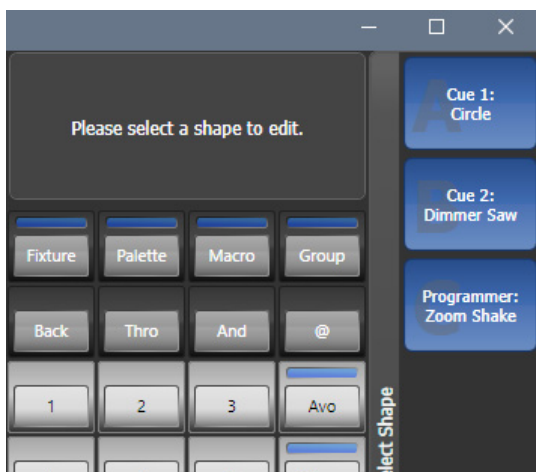

By default all shapes are selected. Choose the shapes to control and press <Enter> or <Shape> to connect the shapes to the wheels to change the speed, size and spread. If there are more than 3 parameters to control, Softkey G will change the wheels to different options.

- If the shapes are in a cue, changes you make here will be automatically stored in the cue (like speed and crossfade are when you are running a chase).
- To control other attributes using the wheels while in this mode, press an attribute button. To get back to shape mode press <Shape> or select the FX attribute in the wheels display.
- If the console does not have a <Shape> button you can access this function using [Shapes and Effects] – [Shape Generator] – [Edit].

7.4.2 EDITING SHAPES AND EFFECTS IN CUES

Shapes and pixel mapper effects stored in cues can be edited from the Cue View window.

Playback View - Cue 'Fast Dim Shape'										
	Delay In	Fade In	Fade Out	Fixture Overlap	MiD Delay	MiD Fade	Curve	View Cue	View Shape	View Pixel Effect
0	0	0	Disabled	100%	0	0	Linear	View	Dimmer Pulse 1:1	

To view and/or edit the parameters of the shape or effect, click on the View Shape or View Pixel Effect button. If more than one shape or effect is stored, the button will show [...]. A Shape View window or Pixel Mapper Effect View window will open, listing the shapes or effects in the cue. You can then edit parameters of the shape or effect by clicking on the parameter and editing on the softkeys.

In the Shape or Effect View window you can click on View Fixtures to open a window showing a list of the fixtures on which the shape or effect is programmed.

7.4.3 EDITING A SHAPE IN A CUE USING INCLUDE

You can only edit shapes which are in the programmer; if you fire a cue with a shape in it, the shape will not show up in the list of editable shapes. To get the shape into the programmer you need to use the Include function (see section 8.4.4 on page 212).

Once the cue is loaded into the programmer using Include, if more than one shape is running in the programmer, you can select which one is connected to the control wheels using Shape option [Edit].

- 1> If you are not in the Shape menu, press [Shapes and Effects] then [Shape Generator] at the top menu.
 - 2> Press [Edit].
 - 3> Press [Select shape]
 - 4> By the softkeys is a list of the currently running shapes.
 - 5> Press a softkey to make the shape active. The active shape is highlighted.
 - 6> Press <Enter> to get back to the Shape Generator menu.
- If you applied the same shape several times to different fixtures, you can change each copy of the shape independently.

7.4.4 RESYNCHRONISE SHAPES

The [Restart Shapes] option in the Shape Edit menu allows you to restart all running shapes, this is useful if you have multiple shapes in a cue and you need to see how they will start up when the cue is fired.

7.4.5 CHANGING FIXTURE ORDER IN A SHAPE

The way a shape spreads across a number of fixtures is set by the order in which you selected them when you create the shape. You can change this order using the [Fixture

Order] function in the [Edit] menu. The current fixture order is shown in in the fixture touch keys . See section 8.6.2 for details on how to change the fixture order.

7.4.6 SHAPES LINKED TO GROUPS

If a shape is created from a group of fixtures, the fixture order or 2D layout in the group will be used when generating the shape. The shape will contain a link to the group and any changes later made to the group such as changing the fixture order or layout will affect the shape. (new in v10.1)

If you need to add fixtures to the group without breaking the group link, select the fixtures then press <Record>, Group handle button, [Merge]. To change the fixtures to a new selection, select them then press <Record>, Group handle button, [Replace]. You can also use <Group> [Edit Groups].

If you want to change the fixture order for a particular shape without changing the order in the group, which might affect other shapes, then you can break the link to the group using the [Break Group References] button in the [Edit] [Edit Fixtures/Groups] [Fixture Order] menu.

See section 5.3.2 on page 135 for how to edit the fixture order or layout.

7.4.7 REMOVING OR ADDING FIXTURES

You can add or remove individual fixtures from a shape using the [Add/Remove Fixtures] option in the [Edit] menu, or use the context menu button in the Shapes Fixture view window. All fixtures currently included in the shape will be selected. You can select or deselect fixtures to add or remove them from the shape.

If a fixture group was used to create the shape, removing fixtures from the shape using this option will break the link to the group. A [Remove Fixtures] confirmation softkey will be shown to warn you of this.

7.4.8 REVERSING A SHAPE

You can reverse the direction of a shape by pressing [Reverse Selected Fixtures] from the shape menu. The shape will be reversed only on fixtures which are selected, allowing you to run the shape forward on some fixtures and backwards on others.

7.4.9 DELETING SHAPES

You can delete a running shape by pressing [Delete] from the shape menu, then pressing the softkey for the shape you want to delete.

7.5 ADVANCED OPTIONS

7.5.1 FADING SHAPE SIZE AND SPEED

When a shape is stored in a cue, you can set how the shape fades in using the Edit Times and the Playback Option settings.

To set the shape size and/or speed from the fader position, press [Playback Options] from the main menu then press the select button of the playback.

Using the [Fader] [Shape Size] and [Shape Speed] buttons you can set the shape size and speed to be fixed (how you programmed them) or to grow larger/speed up as the fader is pushed up. You can also allocate a Speed or Size Master to control the speed or size, see section 13.1.4 on page 284..



When you use dimmer shapes, set the playback to [Shape Size on Fader] so that the shape fades in as you push up the fader. Otherwise the dimmer shape will snap in at full brightness when the fader passes the trigger point. From Titan v9 this is the default setting.

To set a fixed fade in time for the shape size, press [Edit Times] from the top menu, then the playback select button, then set the Delay/Fade times you want.

The Fade Mode allows you to set mode 0 (fade in), mode 1 (fade in and out) or mode 3 (crossfade). Mode 2 links fade times to the fader position, however we recommend you use the Playback Options listed above to do this for shapes, and do not use Mode 2.

If a new cue is fired which controls the same attributes (for example, a second shape controlling the same fixtures as a currently running shape), the new shape will crossfade from the running shape.

7.6 PIXEL MAPPER EXAMPLES

7.6.1 RANDOMISING EFFECTS

This example shows you how to use the pixel mapper to create an effect where random dimmer cells turn on. This effect will overlay any existing intensities.

- 1> *The fixtures you want to use need to be recorded into a group, do this first if they are not already.*
- 2> *Adjust the layout of the fixtures in the group using [Shapes And Effects]/[Pixel Mapper]/[Edit Group Layout]/(select group).*
- 3> *Start creating an effect by selecting the group then [Shapes And Effects]/[Pixel Mapper]/[Create Effect].*
- 4> *In the Pixel Mapper Effect Editor window toggle the context menu option 'Fixture Overlay' until it reads 'Fixture Overlay 50/50'. (This will allow you to see the relationship of your fixtures to the effect as you create it.)*

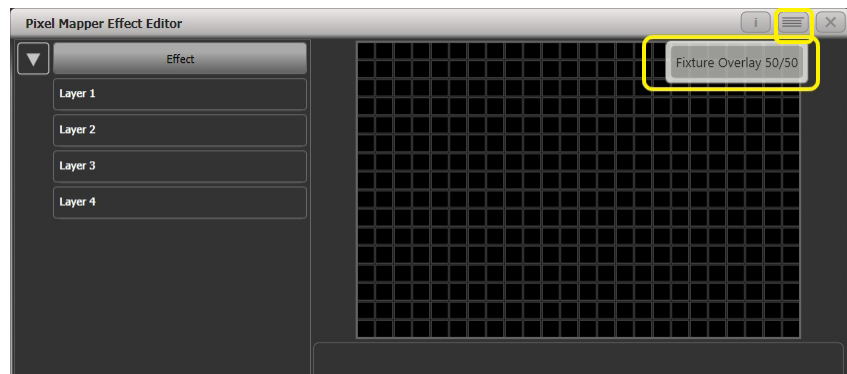

5> Select [Effect] and drag 'Background Opacity' slider to 0%. (This will allow the whole effect to overlay any related intensities.)

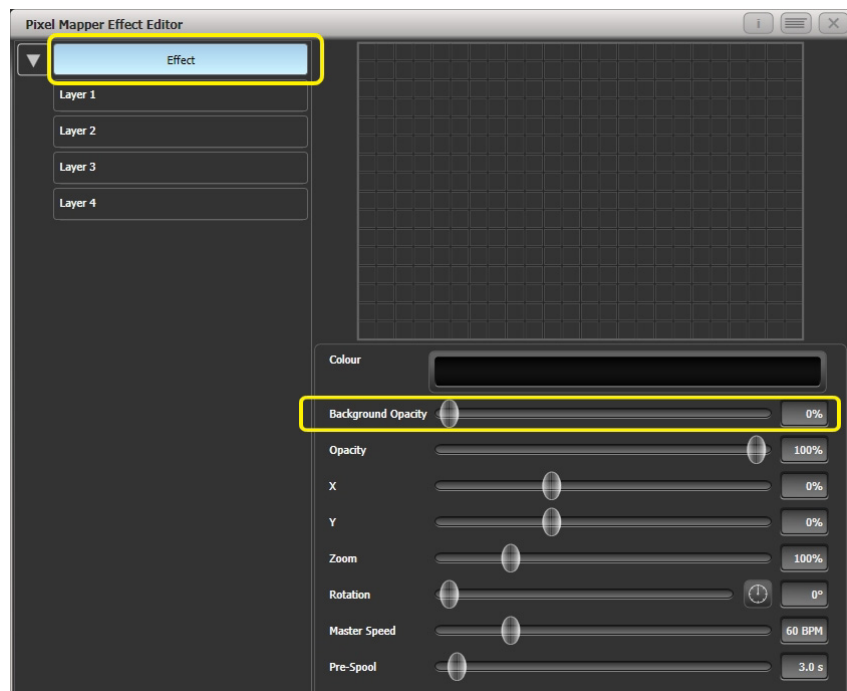

6> Select [Layer 1], click [+] at the bottom of the screen and then choose Circle from the elements that appear.

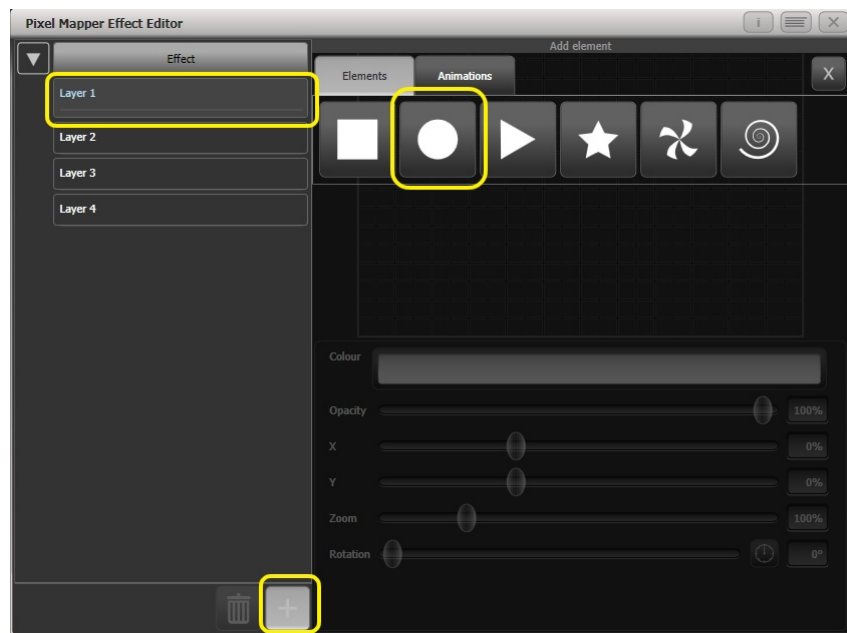

- 7> Drag the 'Zoom' slider until the circle covers approximately one cell. You can also use the 'Width' and 'Height' sliders to turn the circle into an oval if that helps. Then drag the 'X' and 'Y' sliders to position the circle roughly in the centre of your fixtures if it is not already.

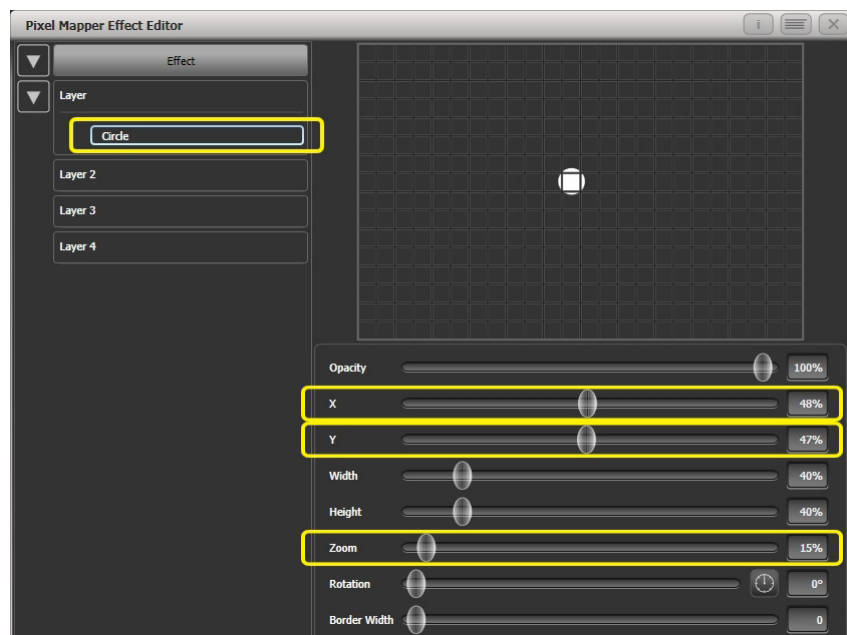

- 8> Select [+] again and choose Displacement from the animations that appear (this is represented as a few static blocks). (Note that nothing changes yet.)

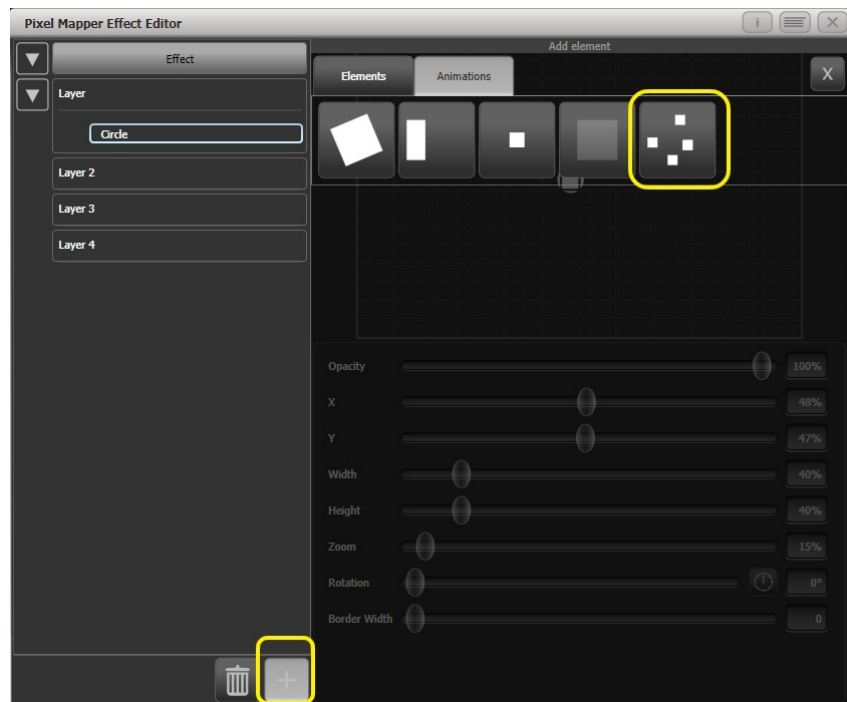

9> Select [+] and this time choose *Opacity animation* (represented as a block fading in).

The displacement acts on the opacity animation causing it to appear at random locations each time it is drawn.

Drag the 'In Time' and 'Out Time' sliders to 0%. (This will cause the effect to snap on/off instead of fade.)

Increase the 'Speed' and 'Spawn Rate' settings to make the effect run quicker and with more circles respectively. (High spawn rates are particularly useful for small randomised elements like this.)

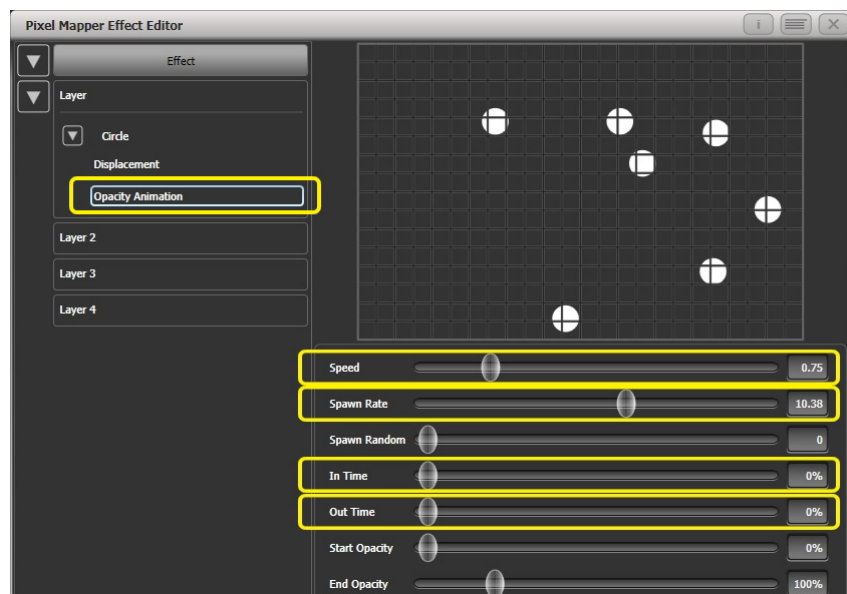

10> Record to a playback.

7.6.2 OVERLAYING EFFECTS

This example shows you how to create a diagonal white wipe with a rotating red fan on top.

- 1> Select a group containing a fixture layout as described in previous example.
- 2> Start creating an effect by selecting the group then [Shapes And Effects]/[Pixel Mapper]/[Create Effect]
- 3> Select [Layer 1], click [+] at the bottom of the screen and then choose Block from the elements that appear.

Drag the 'Rotation' slider to the right to angle the element at approximately 25 degrees.

Drag the 'Width' slider to the left to make a thinner block.

Drag the 'Height' slider to the right until the block fills the height of the entire window.

Drag the 'X' slider to the right until the block is just off the screen.

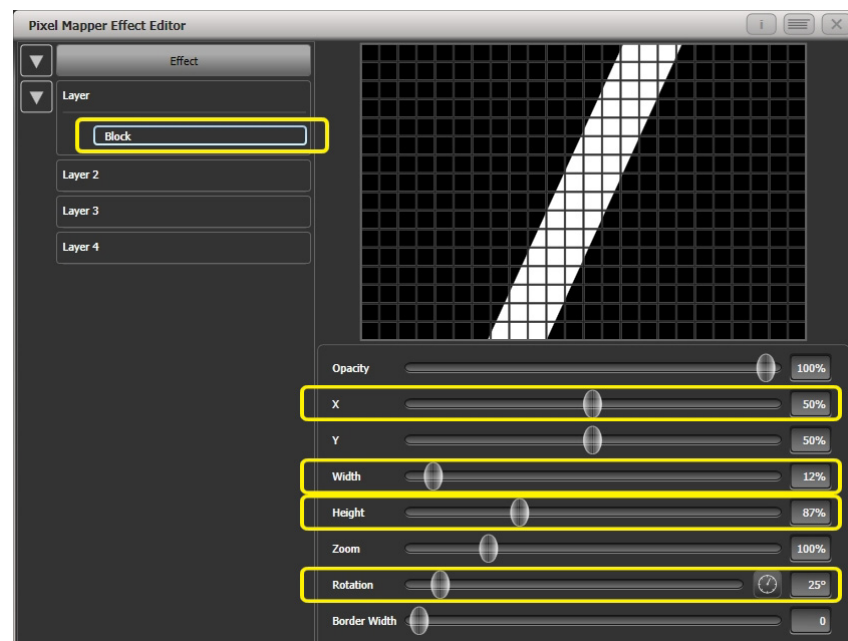

- 4> Click [+] again and choose Linear Movement animation (represented as a block moving left to right).
On the right side of the 'Direction' slider there is a compass button. Click on this four times until the direction reads 270 degrees. (By default the animation is set to 90 degrees or left to right. Because we placed the block on the far right of the screen we want it to move the other way. The compass gives shortcuts to the more common directions in 45 degree increments.)

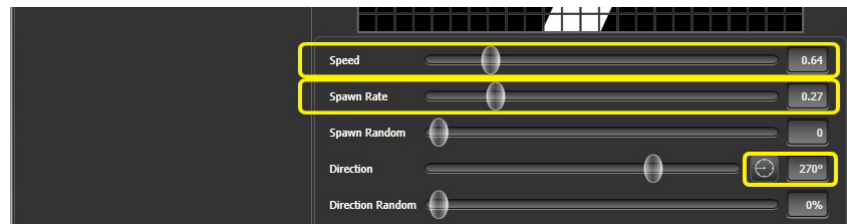

Reduce 'Spawn Rate' until only one stripe is on screen the same time. For this type of effect the value will usually need to be quite low - approximately 0.2.

You might want to reduce 'Speed' slightly at this point. (Note that a higher speed was initially useful for getting the correct spawn rate above.)

- 5> Click on [Layer 2], select [+] and select the Swirl element (represented by a 'fan' shape with four arms).

Increase 'Zoom' until it is as large as will fit in the screen.

Set 'Bend' to 0% for nice straight fan blade edges.

Set 'Points' to 3 (minimum) for a three bladed fan.

Set 'Thickness' to 50% for evenly sized segments.

Increase 'Border Width' to a low value so that we just have an outline.

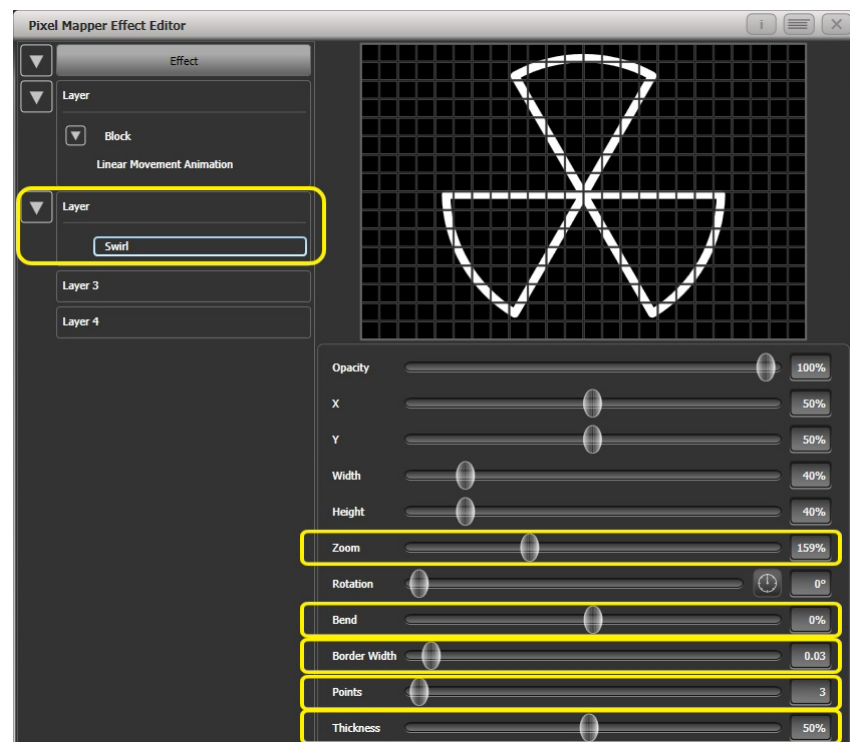

- 6> Click on [+] and add a spin animation.

Reduce the speed until it just causes a light breeze.

- 7> Click in the top of this layer to get the layer controls.

Click on the colour bar to open the colour picker.

Click and drag to the top left of the picker window to get a strong red.

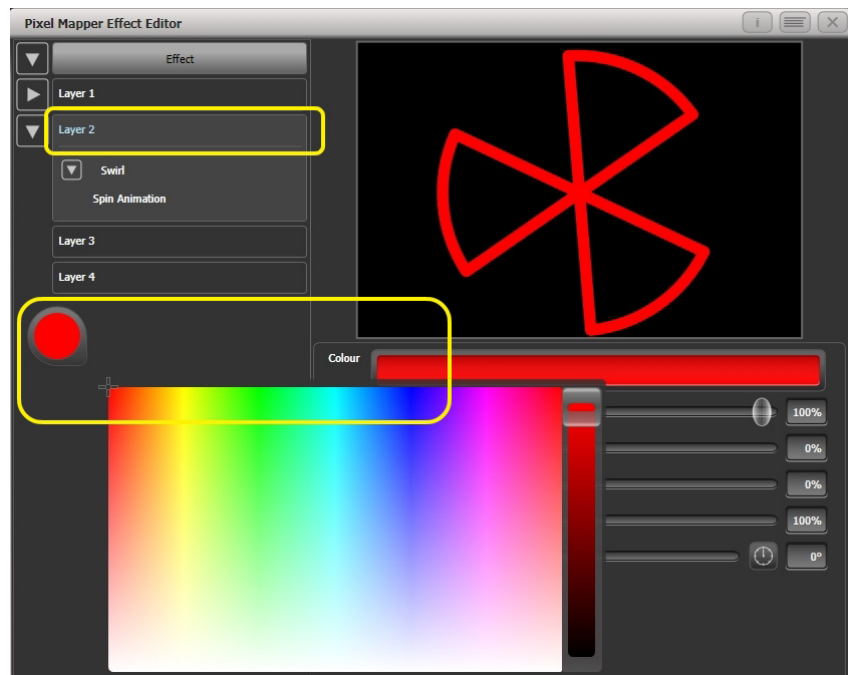

- 8> Click on [Effect] at the top left to access the global controls.
 Drag 'Pre Spool' to the left until it reads 0s. (This is to ensure the wipe begins off screen where we placed it when it is fired.)
- 9> Record the cue.

- Note how the red fan sits on top of the white bar when they interact. This is because the white is on a lower layer. A higher layer number has priority over a lower number.

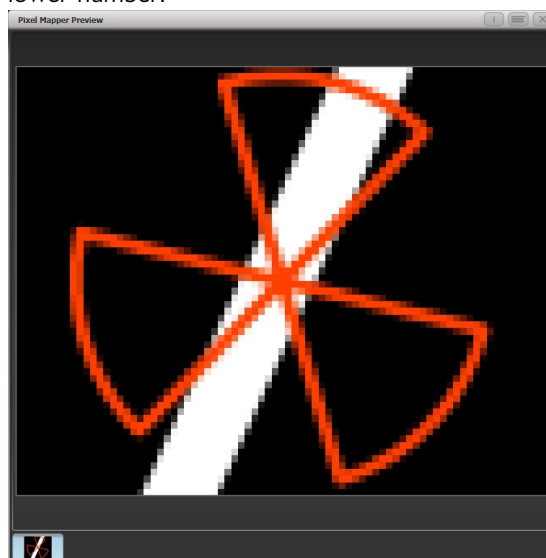

7.6.3 CREATIVE USE OF FIXTURE LAYOUTS

Because each fixture group can contain a different layout it is possible to create more than one arrangement of the same fixtures for pixel mapping.

By arranging fixtures in certain layouts you can easily achieve complex effects.

Example 1: Odd/Even

- 1> Select your fixtures.
- 2> Open the Selection Pattern menu by pressing the 'All' key.
- 3> Choose [Odd] from the softkey options. (This will select all the odd numbered fixtures according to fixture order.)
- 4> Record a group.
- 5> Press '+1' (or 'Next') key. (This will select all the even numbered fixtures.)
- 6> Merge this into the first group.
- 7> Open the Layout Editor. ([Shapes And Effects]/[Pixel Mapper]/[Edit Group Layout]/(select group).)

By doing the above you should be able to see how we have quickly created a layout where the all the odd fixtures are arranged together on the left followed by all the even fixtures on the right.

This arrangement could be used as it is. A block element animated to run horizontally left to right will run across all your odd fixtures followed by all the even fixtures.

An alternative goal might be a vertical 'cascading' effect:

- 1> Click on the vertical resize tool and drag down until the grid is at least twice the original height.

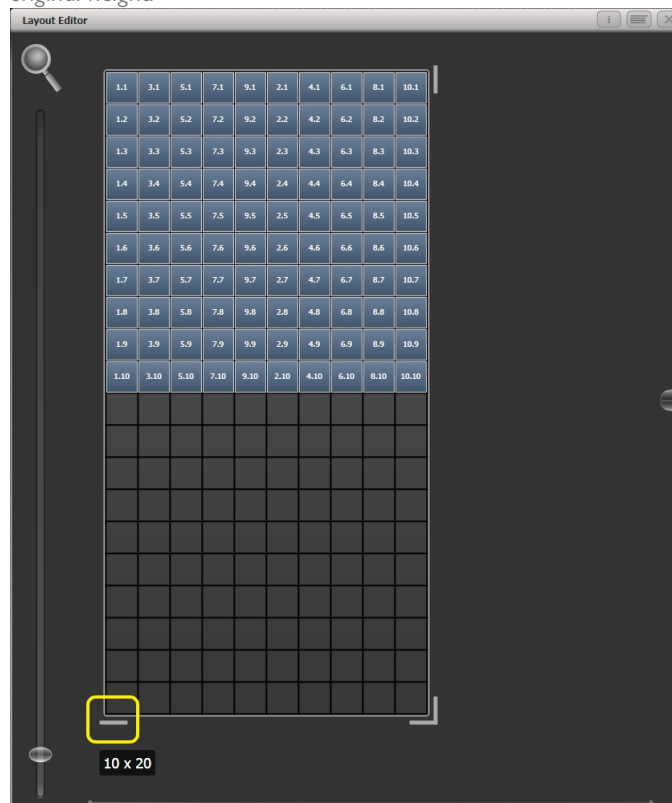

2> Drag a marquee select across the even fixtures.

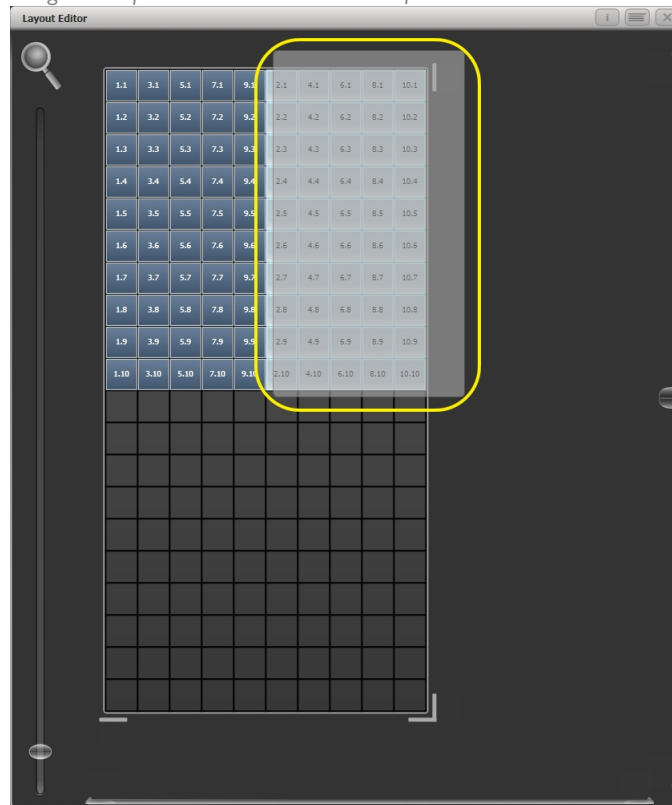

3> Drag the selected fixtures so they sit directly under the odd fixtures.

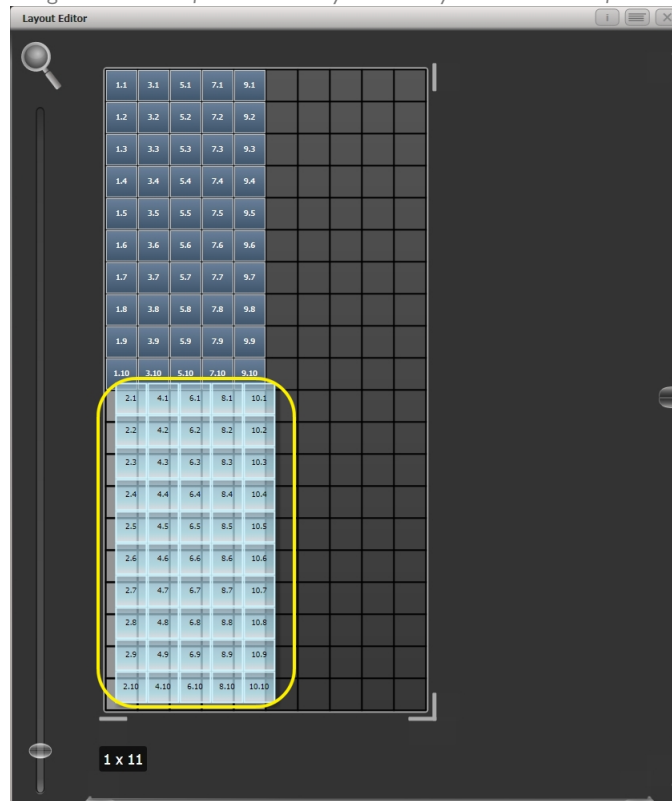

4> Select 'Crop Grid' from the Layout Editor context menu. (This will get rid of the unused pixels.)

Now a block element animated to run vertically from top to bottom will run down the odd fixtures followed by the even fixtures.

Example 2 - Pseudo random

- 1> Select your fixtures and create a group.
- 2> Open the Layout Editor.
- 3> Click on the vertical resize tool and drag down until the grid is at least twice the original height.
Note that to help with creation and manipulation of larger grids you can use the zoom control on the left-side of the window. Clicking on the magnifying glass gives a quick shortcut to zoom in/out.
- 4> Select the group again. (This will quickly select everything in the layout.)
- 5> Press '+1' key. (This will select the first fixture.)
- 6> Use the wheel to adjust 'Position Y'.

Repeat steps 4 and 5 until all the fixtures are at different heights in relation to one another.

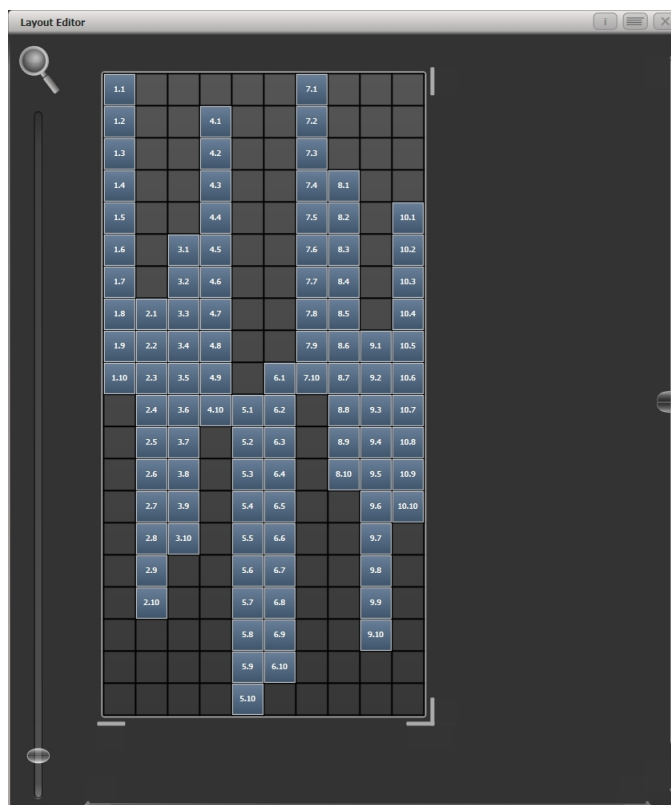

If you create an effect using this group it will appear to be random. Adjustments can be made to the layout at any time to fine-tune the end result.

Example 3 - Angles (or 'when straight just isn't good enough..'):

Sometimes we like to hang fixtures at artistic angles to look pretty. By default the software assumes you have hung them vertically but fear not - Titan has a solution:

- 1> Select your fixtures and create a group.
- 2> Open the Layout Editor.

- 3> Select the fixture(s) that you want to angle and use the appropriate wheel to control. (If wheels are not assigned to control the cell layout you can toggle this on/off using the context menu item 'Wheel Control'. Also, on the Pearl Expert you may need to select 'Adjust Angle' and to return wheels to controlling position select 'Adjust X,Y'.)

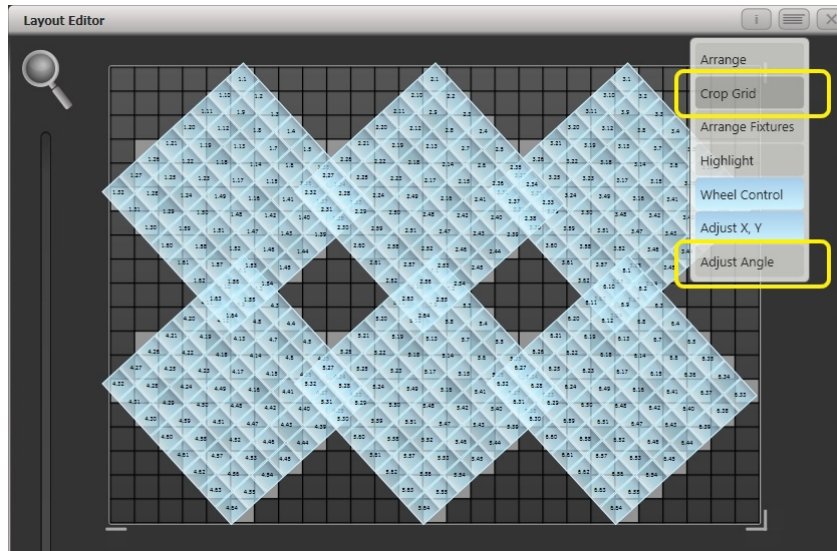

Note that underneath the visual representation of the fixtures the actual cells used are shown in light grey.

If any of your fixtures have been naughty and ended up beyond the bounds of the grid after rotating you can use context menu item 'Crop Grid' to make them behave.

When using the wheels to move fixtures, you can click on the “up” and “down” areas in the wheel display to nudge the values up and down – 1 pixel for position and 45 degrees for rotate. If you press the @ button for the wheel, a window opens allowing you to type in the values numerically.

7.6.4 OTHER LAYOUT EDITOR TOOLS

The Layout Editor's context menu has some useful tools for laying out fixtures quickly.

Arrange Fixtures: This is a very useful tool to quickly layout fixtures in a grid. For example you might have 20x Colourblocks across four towers, each with five blocks.

- 1> Select the fixtures and create a group.
- 2> Edit the layout of this group.
- 3> Select 'Arrange Fixtures' from the context menu.
- 4> Select the [Height] softkey and type '5'. (Width will automatically be calculated.)
- 5> Toggle [Crop Grid to fixtures] so that it is highlighted. (This will make the grid adjust to fit.)
- 6> Toggle [Arrange in..] to 'Columns' or 'Rows'. 'Rows' will arrange fixtures left to right and 'Columns' will arrange top to bottom.
- 7> The [Shape] option allows you to arrange in Rectangle, Oval or Triangle.

8> *Select [OK] to complete.*

Highlight: When enabled this will highlight selected fixtures live on stage. This can be useful to see which fixture you are positioning in the layout.

Position & Angle/Cell Scale: When set to 'Position & Angle' the wheels move and rotate the fixtures. When set to 'Cell Scale' the wheels change the size of the fixture by spreading out its cells. This is useful to get the correct layout if you have some large fixtures with widely spaced cells and others with cells close together.

Arrange/Select Only: When set to 'Arrange' you can move fixtures by clicking and dragging on the screen. When set to 'Select Only' fixtures are locked in position on the grid and cannot be dragged around. This provides an alternative way of selecting fixtures to edit while preventing accidental movement.

If you find you suddenly cannot move anything around this is probably the reason!

For either setting you can still use the wheels to move and rotate the fixtures.

Wheels Move Full Pixel/Sub Pixel: Allows you to position fixtures across pixel boundaries when using the wheels. The **Snap** option centres the fixture on the nearest cell.

Wheels Rotate Individual Fixtures/Selection: Sets whether individual fixtures rotate, or whether the whole selection rotates.

Media options: Shows a sub menu with useful options when you're using Synergy/Ai to play back media on the fixture. These options are described in section 12.2.5 on page 279.

7.6.5 PLAYBACK ORDER AND PRIORITIES

Suppose you wished to create a white pulsating oval on one playback and a blue spiral on a second playback. Normally these effects would layer differently depending on the order you fire the playbacks, but you can use playback priorities to make them always layer the same way

To create first effect:

- 1> *Select a group containing a fixture layout as described in previous example and go to [Create Effect].*
- 2> *Select [Effect] to access the global effect controls and change 'Background Opacity' to zero. (This will allow it to overlay the other playback.)*
- 3> *Double-Click [Layer 1] (or press [+]) and choose Circle from the elements that appear. (Double-click is a shortcut to elements and animations.)*

Reduce height to make a rugby ball (or American football if you insist).

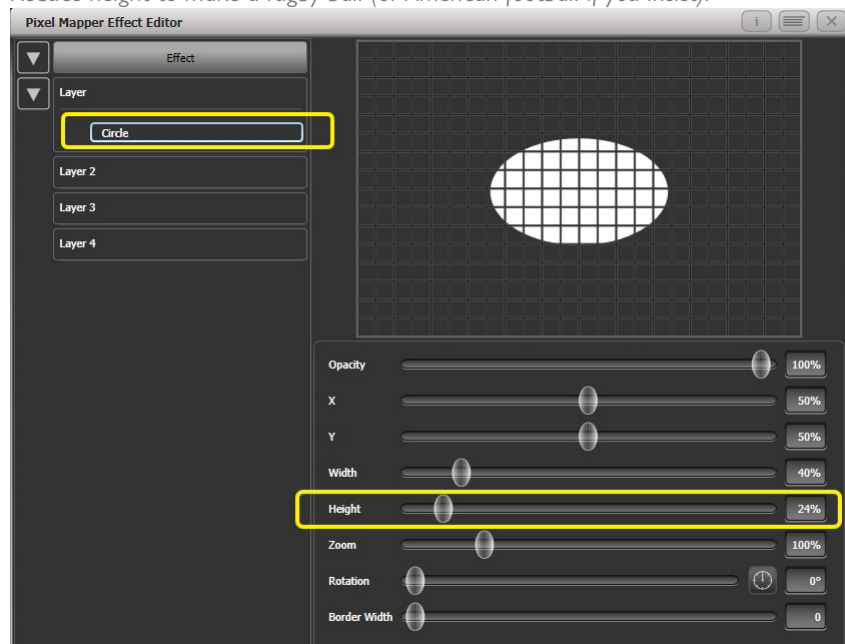

- 4> Double-click on [Circle] (or press [+]) and select the Zoom animation. Drag 'In Time' to zero and 'Out Time' to 100%. (This will make the effect start large and finish small. Alternatively the same effect can be created by making 'Start Zoom' larger than 'End Zoom!')
- Increase 'End Zoom' until the element begins by filling the whole window.
- 5> Double-click on [Zoom Animation] (or press [+]) and select the Opacity animation. Reduce 'Spawn Rate' to zero. (This will ensure the opacity only works on the zoom animation.)
- Drag 'In Time' to zero and 'Out Time' to 100. (This will make the effect snap on and fade out as it reduces in size. As with zoom you can achieve much the same thing by inverting the opacity controls instead. Using opacity values greater than 100% will create a delay before fade.)

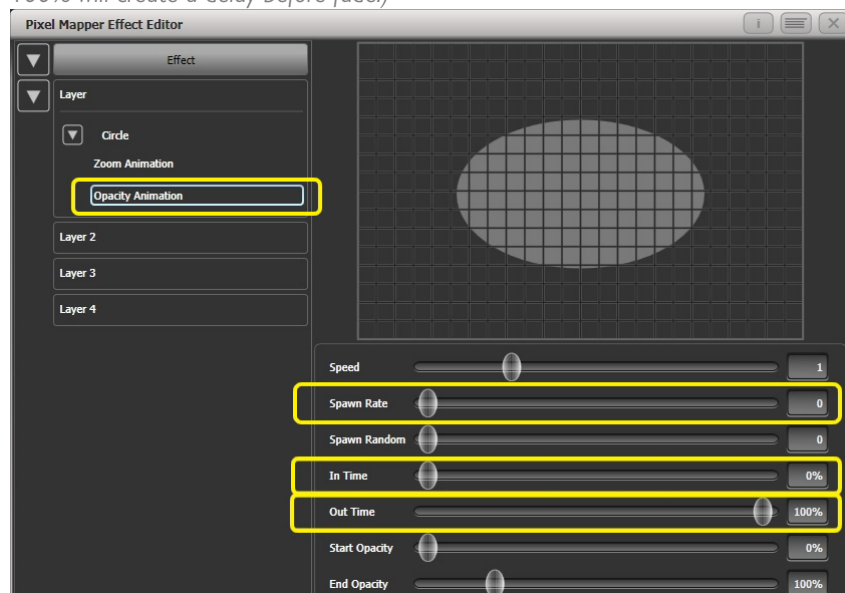

- 6> Click on [Effect] again and reduce 'Master Speed' to your preference. (Adjusting the global speed control ensures the zoom and opacity animations are synchronised

instead of having to manually match the individual values.)

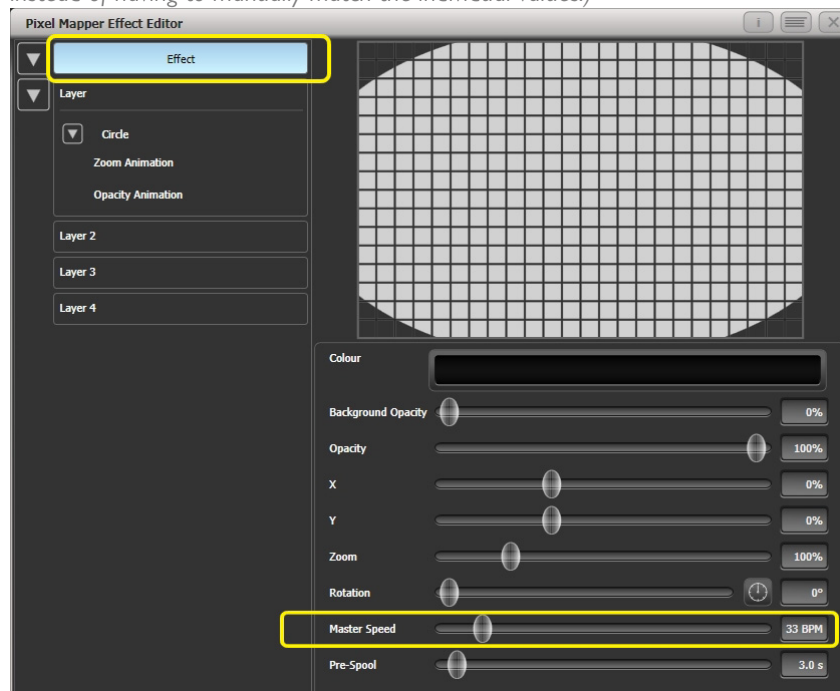

7> Record the cue.

Next we will create the second effect:

- 1> Select the same group as used for the first effect and [Create Effect]
- 2> Select [Effect] and change 'Background Opacity' to zero.
- 3> Select [Layer 1] and this time add a Spiral element.
 Increase 'Zoom' so that it's nice and big.
 Drag 'Thinning' until it is at 0%. (This will make the lines of the spiral stay the same width. A negative value means the spiral gets thinner towards the outside; a positive value means it gets thinner towards the inside.)
 Reduce 'Turns' so we can make a more bold effect. Approx. 3 should work.
 Increase 'Thickness' to 50% for chunky lines.

Increase 'Exponent' to around 25%. (This causes the spiral to 'expand' at a faster rate.)

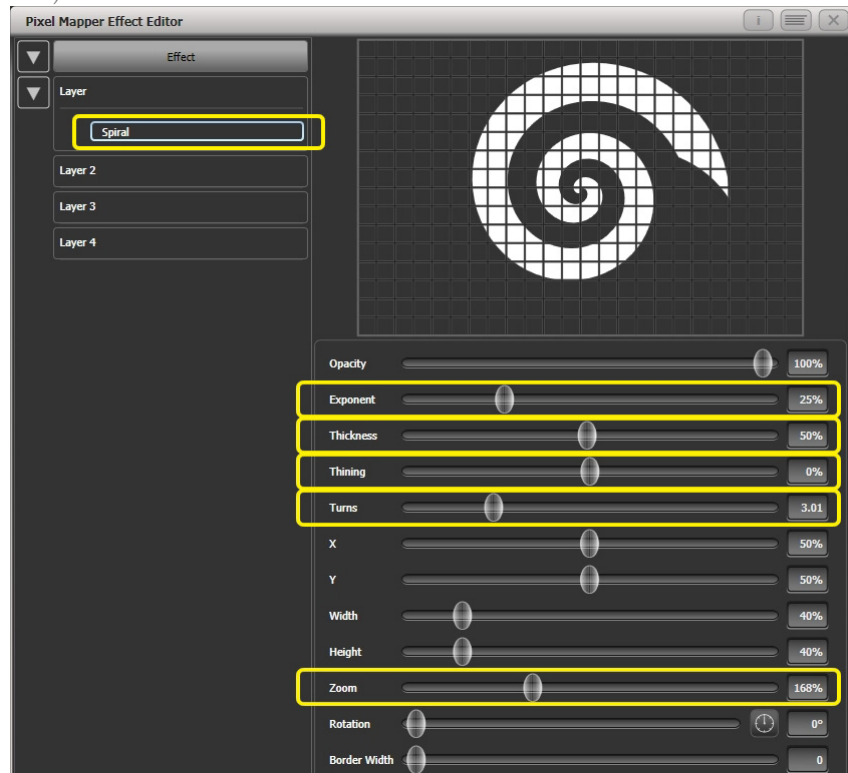

- 4> Add a Spin animation for genuine psychedelic effect.
Adjust speed until you are unable to look away from the screen.
- 5> Select the Layer to show the layer controls and change the colour to blue using the colour picker.

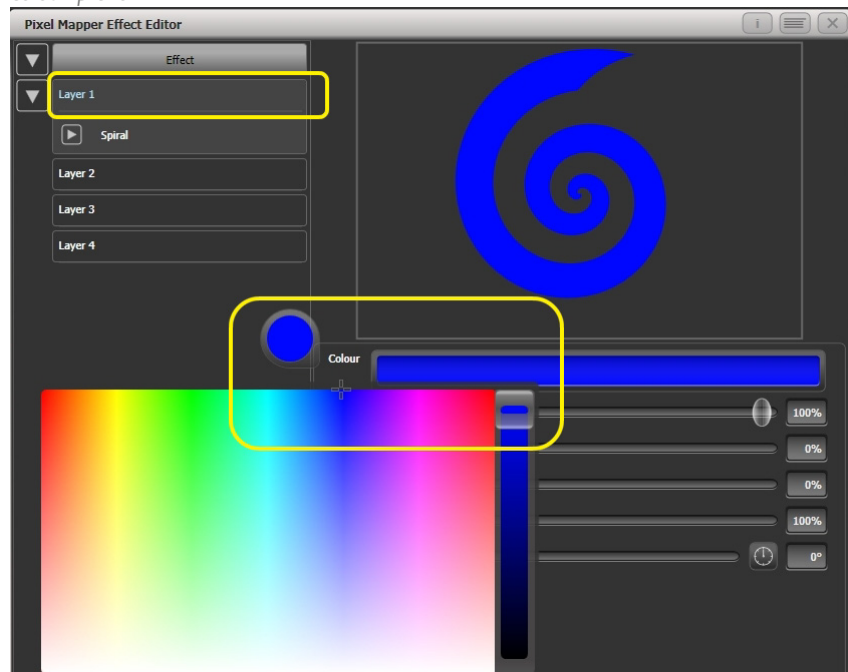

- 6> Record the cue.

Now let's look at how they interact on the playbacks:

- Fire the blue spiral effect.
- Fire the white pulse.

Notice how the white takes priority over the spiral. The blue spiral only appears as the white oval fades out and gets smaller.

- Kill both effects.
- Fire the white pulse.
- Fire the blue spiral.

This time the blue spiral sits on top of the white pulse. That is because the playbacks are following a 'latest takes precedence' rule (LTP).

To guarantee the blue spiral always sits on top you can set it to be a higher priority:

- Kill both effects.
- [Playback Options]/Select the blue spiral playback.
- Press [Previous] or [Next] until you can see [Priority Normal] on the softkeys. Press this to toggle it to [Priority High].
- Now fire the blue spiral followed by the white pulse.

Even though you fired them in the same order as the first example the blue spiral now sits on top of the white pulse because it has a higher priority.

7.6.6 DISPLACEMENT AND LAYER PROPERTIES

In this example we create random flashing bars, and use layer controls to make global adjustments to the whole effect.

- 1> Create a group and adjust the fixture layout as described in previous examples.
- 2> Select this group and begin creating an effect.
- 3> Select [Layer 1] and add a 'Block' element.

- 4> Adjust the width and height sliders until we have a thin strip that covers at least one cell vertically and the whole grid horizontally.

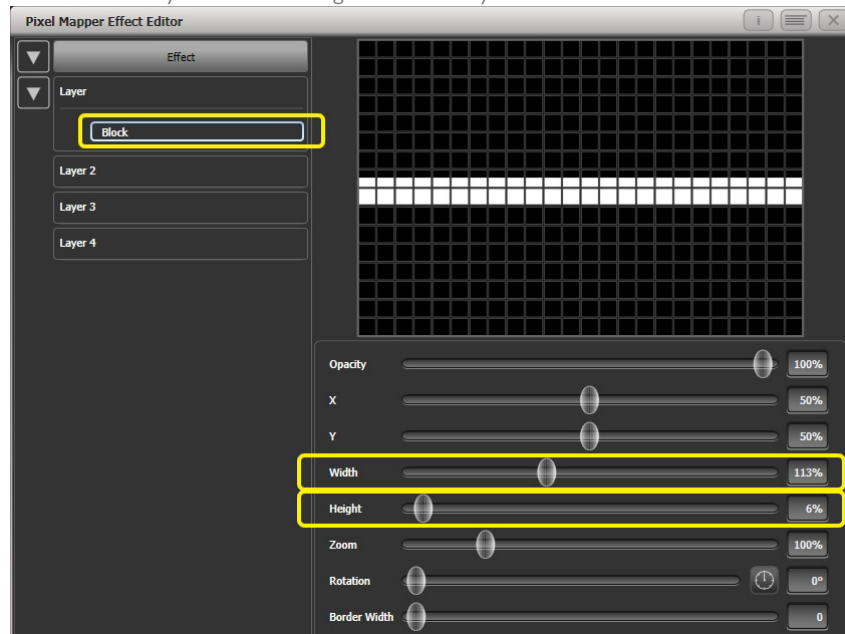

- 5> Reduce Y until the bar disappears off the top of the grid. (This is in preparation for adding a displacement animation.)

- 6> Add a Displacement animation. By default this will offset the original position by anything up to 30% distance. This is because the default value for 'Distance' is set to a maximum of 30% and 'Distance Random' is set to 100% meaning it can use any random value between zero and 30%. Similarly 'Direction Random' is set to 100% meaning it can offset in any direction.

Temporarily set 'Distance Random' to zero. (This is in order to see exactly what the displacement is doing.)

Set 'Direction Random' to zero. (In this example we do not require a random direction.) Now the bar will disappear because it is being displaced upwards in the default settings.

Set 'Direction' to 180 degrees. Click on the compass button four times to get there quickly. Now the bar should reappear on the screen because it has been offset vertically down from the our off-screen position by the default 30%.

Increase 'Distance' until the bar is approximately in the centre.

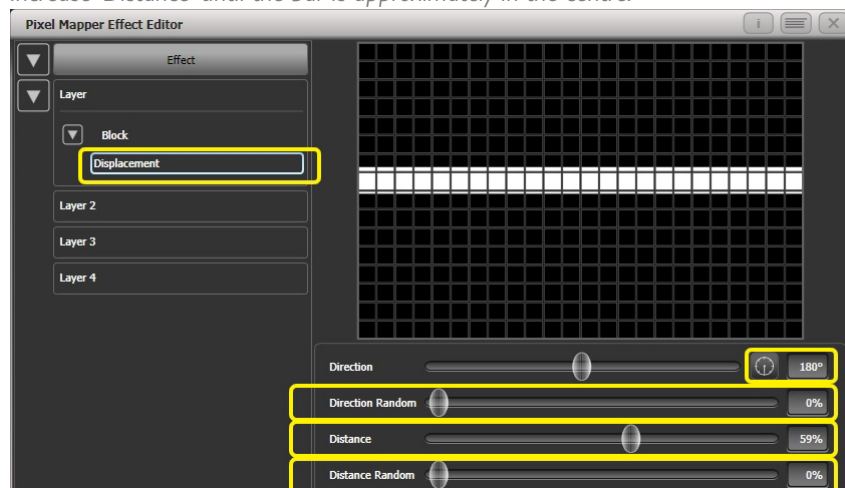

7> Add an Opacity animation.

Reduce 'In Time' and 'Out Time' to create a snapping effect.

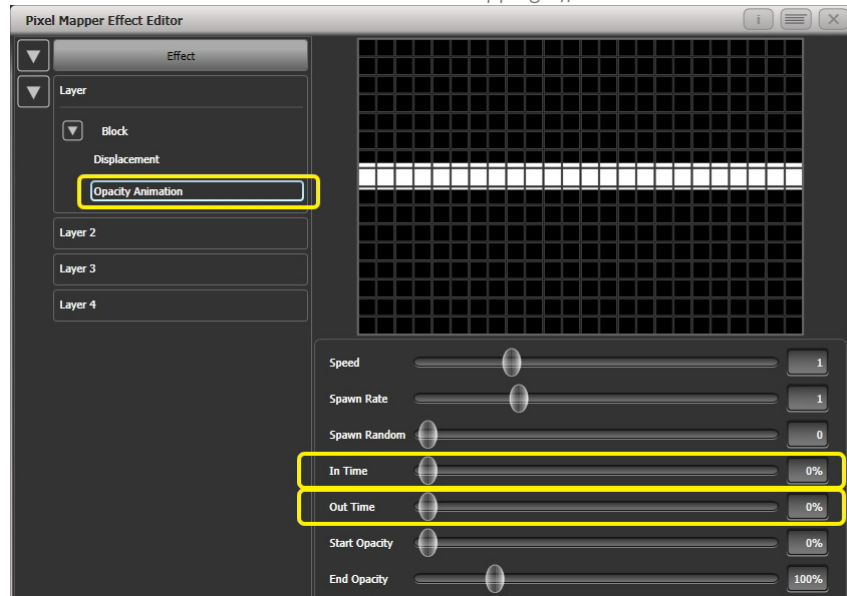

8> Click on 'Displacement' in the Layer to get back to the controls for this animation again.

Now increase 'Distance Random' to 100%. (This will make the bar draw at a random offset around the 'Distance' setting, in this case making it anywhere within the grid.)

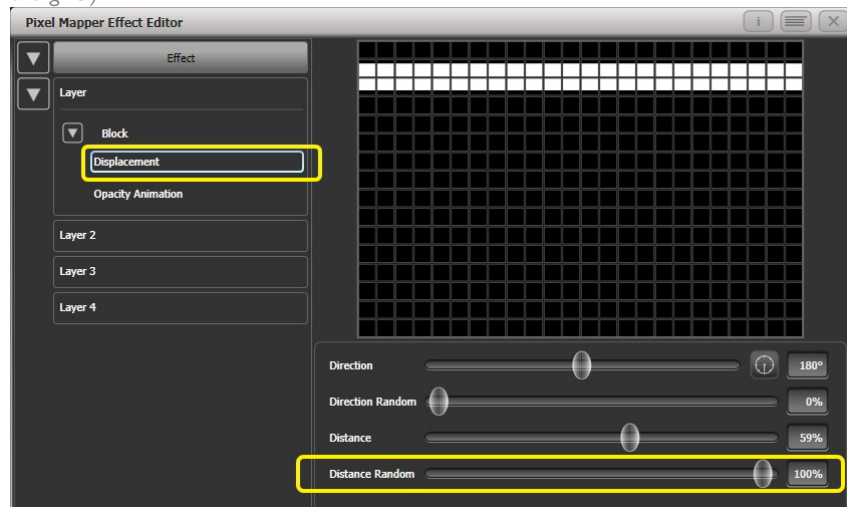

9> Return to the Opacity animation controls and increase speed until you're happy.

10> At this point you may decide actually the effect would be better if it was a vertical bar. To make this easy we can make adjustments on the layer controls rather than on the individual element and animations:

Select [Layer 1] to bring up the layer controls.

Change 'Rotation' to 90 degrees by clicking on the compass button twice.

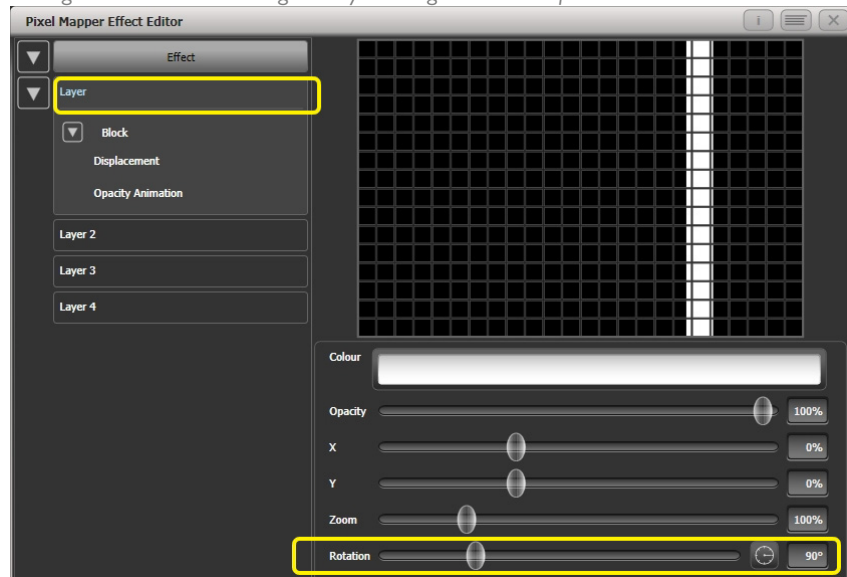

Now you have a vertical bar that draws randomly using a horizontal displacement. Similarly you can use the [layer] or [effect] controls to make global changes to X/Y position and Zoom allowing quick manipulation of entire effects.

7.6.7 SPAWN AND PRE-SPOOL

The director has asked for lots of animated spinning shurikens that slowly move across a backdrop while pulsating. It is a mystery why, but you know how it is with directors.

- 1> Select a group with an appropriate layout.
- 2> Add a Star element.
Change 'Points' to 4 for a classic shuriken.

Reduce 'Zoom' so that we can fit lots of baby shurikens in the grid.

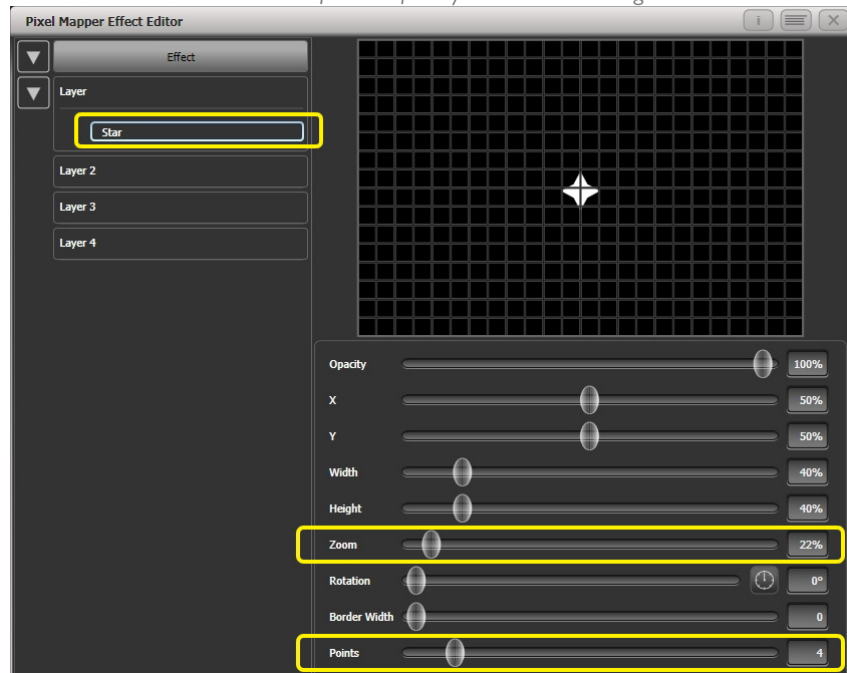

- 3> Add a Spin animation.
Reduce 'Speed' so they are relatively harmless.
- 4> Add a Linear Movement animation.
Slow it down so it looks like it is rolling along.
- 5> Select the Star element again and change 'X' so the shuriken starts further from the left and rolls along the whole grid.

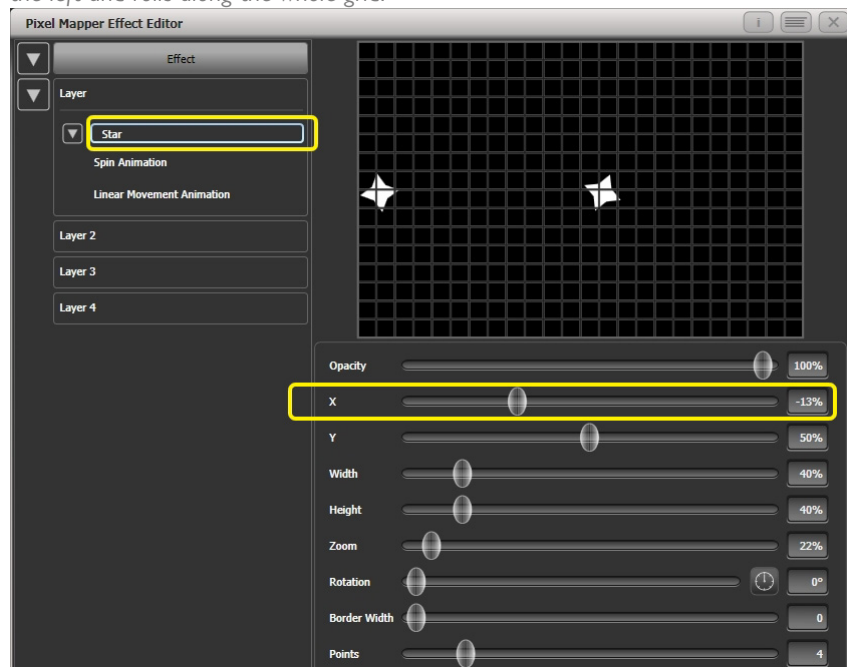

- 6> Add a Displacement animation.
Now each new shuriken starts rolling at a different height on the grid.
- 7> Go back to the Linear Movement animation and increase 'Spawn Rate' so that more shurikens are on screen at once. (This determines how frequently a new element appears.)

Increase 'Direction Random' slightly. (This will allow a random variation in the direction of travel based upon the 'Direction' value.)

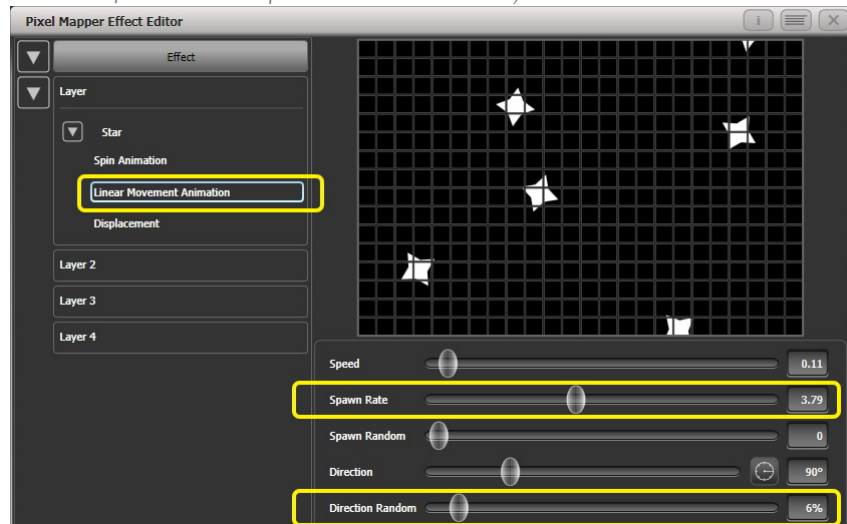

8> Add a Zoom animation.

Reduce 'Spawn Rate' to zero. (This is a special setting that will allow the zoom animation to run continuously during the life of a shuriken. If the rate is set to 1 it will only run once and the shurikens will quickly disappear as a result.)

Increase 'Out Time' to 100%. (This will make the shurikens pulse in and out with a 'bounce' type effect. I have no idea why they would be doing this in reality.)

Slow the zoom down a bit.

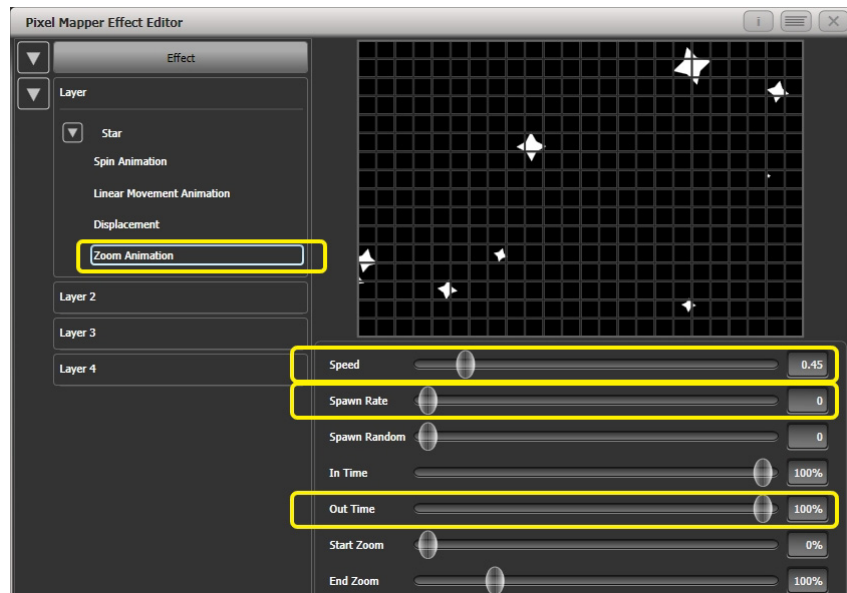

- 9> Click on [Effect] and set 'Pre-Spool' to zero. (This is to demonstrate the purpose of the property.)

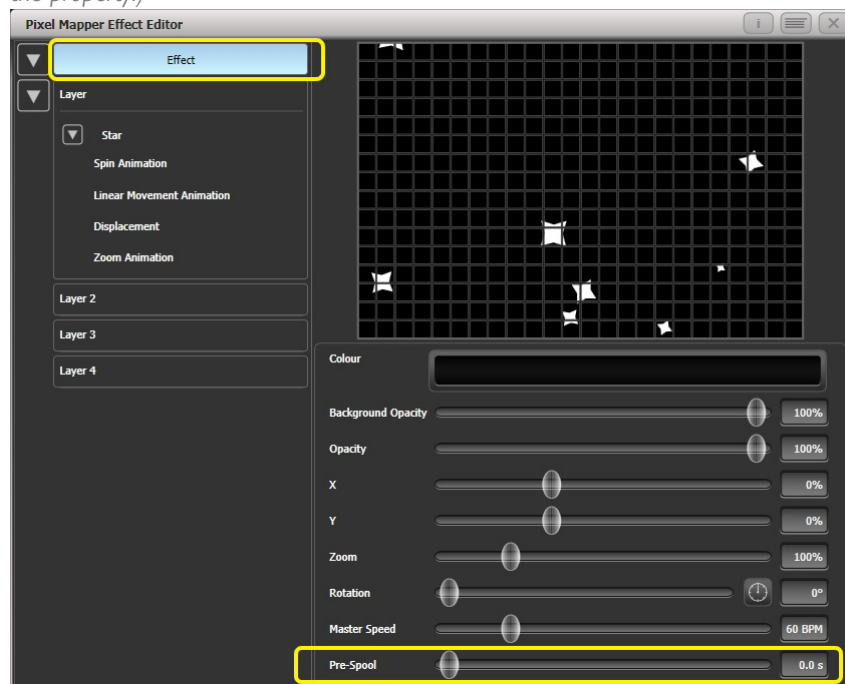

- 10> Store the cue.
- 11> Press clear, open the Pixel Mapper Preview workspace and fire the cue.
You will notice that initially there are no shurikens on the screen and it takes a while to build up to a nice random collection. To fix that we can use 'Pre-Spool'.
- 12> Include the cue and open the Effect Editor workspace if it is not already.
- 13> Select [Effect] and increase the 'Pre-Spool' value to around 20s. (This means the software will pretend 20 seconds has already elapsed when the effect is started.)
- 14> Store the cue, clear, fire and view again in the Pixel Mapper Preview.

This time there should already be plenty of shurikens on screen. Pre-Spool is particularly useful for animations that rely on high spawn rates but run at a low speed.

8. CUES

So you've set up a great look on the stage, and you want to save it to use in your show.

There are three ways of saving looks on Titan.

Cue: This is a single look. It may contain movement in the form of shapes, and have fade in and fade out times.

Chase: This is a timed sequence of cues, often used for an individual effect.

Cue List: This is a linked sequence of cues, usually used to store and replay an entire show or an element of a show from a "go" button.

Chases and Cue Lists are covered in more detail in the following chapters.

When a Cue, Chase or Cue List is stored on a control, the control is called a **Playback**. You can store in several places:

- On any **fader handle** - the fader controls the intensity of fixtures (you can make the fader control other things using Playback Options).
- On a **touch button** in the Playbacks window – you can set whether the button latches or flashes the cue using Key Profiles
- On a **Macro/Executor button** – again you can use Key Profiles to set latch or flash.

If you run out of faders to store playbacks, fader wings are available for all consoles to add more faders.

Titan's cue functions are very powerful; the first part of this section explains the basics of how the console uses cues.

8.1 CREATING A CUE

8.1.1 HOW TITAN WORKS WHEN PROGRAMMING

When you select one or more dimmers or fixtures for control, they are loaded into the *Editor*. You can then use the wheels and palettes to change the settings on the fixture. You can also apply shapes to it.

If a fixture is selected after you have changed some attributes then the current list of fixtures in the Editor is emptied and a new list is started.

All fixtures and attributes that have been edited since the last Clear are stored in the *Programmer*. The order in which you selected the fixtures is also stored, and is used with shapes and the Fixture Overlap function. When you record a cue, the contents of the Programmer are saved into the cue.

When you press <Clear>, the programmer and editor are emptied. This makes sure you don't record fixtures you don't want. You also need to press <Clear> when you finish programming, because any attributes in the programmer will override playbacks.

Fixtures which are in the programmer are shown in mid blue on the touch buttons. Attributes in the programmer (the things you have changed) are shown in cyan on the attribute displays.

Firing a cue does not place the values from the cue in the programmer, so you can't just turn on a playback and record what you see to another cue (although the Include function lets you do this, see section 8.4.4 on page 209).

8.1.2 CREATING A CUE

- 1> Press <Clear> to clear the programmer. This ensures that you are starting with a clean slate.
- 2> Set up the look using the fixtures. You can save shapes in a cue. Remember that only fixtures which are selected or have been modified will be saved in the cue (in Record by Fixture mode).
- 3> Press the <Record> button (<Record Cue> on Pearl Expert).
- 4> Press the Swop button of an empty Playback to record the cue. The handles where you can record the cue will flash. You can also record a cue onto a touch button in the Playbacks window.
- 5> Press <Clear> to clear the programmer. Repeat from 2 to program more cues.

Other useful things to know about recording cues:

- Cues can be recorded to any fader, the macro/executor buttons or the onscreen Playbacks window.
- [Record Mode] lets you select Record By Fixture (all attributes of any modified or selected fixture are saved), Record By Channel (only modified attributes are saved), Record Stage (all fixtures with a non-zero dimmer channel are saved) or Quick Build (see next section).
- Record By Channel is useful if you want to layer multiple cues to create an effect.
- If you are recording a lot of cues, you can press <Menu Latch> to keep the Record Cue menu active. Press <Exit> to leave Record Cue mode.
- The screen immediately above each fader shows a legend for the playback. To set this, press [Set Legend], then the playback Swop button (or the touch select button), then enter a legend on the keyboard or draw a picture legend. Press <Enter> to store it. If the fader or button does not have an associated screen you will have to resort to the old fashioned method of white tape and sharpie.

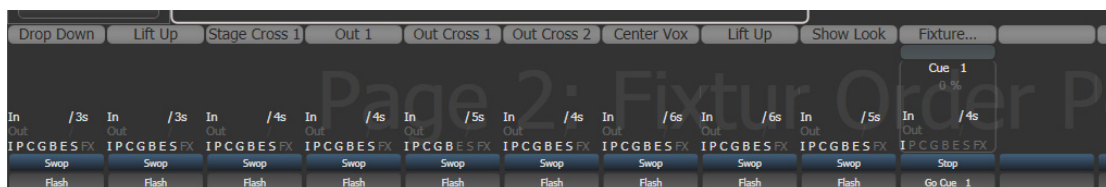

- A Static Playbacks workspace is available to show the contents of the macro/executor buttons and (on the Tiger Touch) the 10 static playback faders.

8.1.3 QUICK BUILD CUES

Setting [Record Mode] to Quick Build allows you to build a cue from existing playbacks or palettes (you can also use the Include function to do this).

After setting the record mode to Quick Build, the console will wait for you to select playbacks or palettes.

To insert specific fixtures from a palette or playback, select the fixtures first and then select the palette or playback.

Press [OK] once you have selected all the playbacks or palettes required.

8.1.4 USING SHAPES/EFFECTS IN CUES

As you would expect, any shapes or Pixel Mapper effects you have set up will be saved as part of the cue.

You can create a cue which contains a shape with no base reference values; a shape cue like this can then be fired with other cues to overlay the shape on the cue and give you instant effects based around the settings in that cue. When recording the cue, use Record by Channel mode or use the "Off" function to remove the other attributes from the programmer as described on page 212.

8.1.5 BLIND MODE

Blind mode allows you to program cues without affecting the current look on the stage. This can be very useful for making changes during a live show. Your changes are still shown in the Visualiser window.

To put the console into blind mode, just press the <Blind> button (on consoles without a dedicated button, hold down <Avo> and select the [Blind] option).

If you want to preview a playback on the visualiser without affecting the stage, playbacks can be set to Blind mode using [Playback Options]. To quickly set a playback to blind mode, hold <Blind> and press the playback select button. Repeat to make it Live again.

You can fade your blind state to the live output by typing in a fade time number then pressing <Blind>. This allows you to recall several palettes together, or create a live state to be output without needing to save it to a cue.

8.1.6 RECORDING CUE WITH A MASK

You can set a mask when recording a cue so that only certain attributes are recorded, the same as you can when recording a palette. In the Record menu, select the [Set Mask] option.

There is an additional option [Clear Record Mask], if this is enabled the mask will automatically be cleared after this record operation. This is good to stop you accidentally leaving the mask set and causing havoc with future cues.

8.1.7 CONVERT CUE TO CHASE OR CUE LIST

If you want to convert an existing cue into chase or cue list by adding further steps, press <Record>, select the cue, then select [Convert to Chase] (or Cue List). The existing cue will become cue 1 and the contents of the programmer will become a new cue 2.

8.2 USING A CUE

Because it's possible to play back a large number of cues at the same time, the console has to have rules on how it combines the output from different cues. These are called HTP and LTP rules.

8.2.1 COMBINING CUES WITH HTP AND LTP

Control channels are handled in two ways:

- Dimmer or intensity channels work on the principle of "Highest Takes Precedence" (HTP). If an HTP channel is active at different levels in several cues, the highest level will be output. When you fade out a cue, the HTP channels fade out with it.
- All other channels work on the principle of "Latest Takes Precedence" (LTP). The latest change takes over from any other values, so the most recent cue to be turned on is the one which is output. When you fade out a cue, LTP channels retain their values until changed by another cue.

8.2.2 PLAYING BACK A CUE

To fire (play back) a cue, raise the fader. (Make sure there are no values in the programmer by pressing the Clear button, because anything in the programmer will override the playback).

- You can fire several cues at once.
- The HTP levels in the cue will be mastered by the fader level; for example if you set the fader at 50% then all HTP levels will be 50% of their programmed values.
- LTP channels are triggered as soon as the fader goes above 0%. If a fade time is programmed the LTP channels will start to fade; if there is no fade time they will snap to position (unless the cue is set to Mode 2 in which case they fade with the fader position; see the timings section 8.6 on page 214 for details of modes).
- You can Flash the cue by pressing the grey flash button. You can Swop (solo) the cue by pressing the blue Swop button (all other active cues will turn off while the button is pressed). This assumes you haven't reassigned the function of the buttons using Key Profiles, see below.
- You can Preload the cue by assigning the Preload function to the blue or grey buttons using Key Profiles. Preload sets the attributes of fixtures in the playback which are not currently active in any other playbacks. This is useful to avoid the fixtures visibly moving into position or changing colours or gobos when you raise the fader of the cue. To assign Preload, hold <Avo> Shift and press [Edit Key

Profile], then press the button you want to assign (also see section 16.1.7 on page 321.) Note that this will assign the function to all buttons of the same type.

- You can fire a one-shot cue with timings by assigning the Go function to one of the handle buttons using Key Profiles. This allows you to fire the cue without needing to hold down a button while the timing completes. You can also fire the cue again without needing to release it.
- You can set playbacks to high priority if you do not want them to be overridden by other playbacks using the same fixtures. For example, if you have a couple of fixtures acting as a spotlight, but they are also programmed into some colour washes, you probably want the spotlight cue to take priority over the colour washes. See section 8.7.1 on page 220.

8.2.3 CHANGING PLAYBACK PAGES

The console allows multiple pages of playbacks. Page buttons are provided near the faders or you can also touch the top and bottom of the roller graphic on the screen. If you touch the middle of the roller graphic you can jump to a page number by entering the number.

- If you have stored cues on the touch select buttons, you select different pages using the Playbacks page touch buttons.

For consoles without motorised faders:

- Playbacks which are fired when you change page remain active. If you want to fire a cue on a fader which is already up from a previous page, lower the fader to zero then raise it again. The cue from the previous page will stop and the cue from the new page will fire.
- If you return to a page with an active playback, the fader will not resume control of the playback until it matches the current level of the playback. This prevents the playback level jumping when the fader is first moved. If a playback is active from another page the display area is purple and shows the page number at the top in light blue. You can change this behaviour using the [Playback Paging] user setting, see section 16.1.6 on page 320

For consoles with motorised faders:

- Playbacks which are fired when you change page remain active, but thanks to the motorised faders you can then use the fader to fire a playback from the new page. If you want to kill the original playback you need to return to the page it is on and lower the fader back to zero. If a playback is active from another page the display area is purple and shows the page number at the top in light blue. You can change this behaviour to be like consoles without motorised faders using the [Playback Paging] user setting, see section 16.1.6 on page 320 .
- You can set a legend for each playback page. The legend is shown on the 'Pages' roller on the screen. Use [Set Legend] from the main Program menu then [Page Legends]. While in this menu you can change the page to set legends for different pages.
- If your console features the 20 executor buttons on the top right of the console, they can be paged using two of the macro buttons. The page change macros are

part of the fixture library; if you do not see the macros, download and install the latest library.. The same applies to the 10 static playback faders on the Tiger Touch.

8.2.4 VIEWING ACTIVE PLAYBACKS

The Active Playbacks window shows details of which playbacks are active. When you have a number of layered playbacks with different effects, this provides an easy way to see which playback is causing which effect. Each button shows the playback legend, which page they are from and which attributes are affected. To show the window press <View/Open>, [Open Workspace Window], [Active Playbacks].

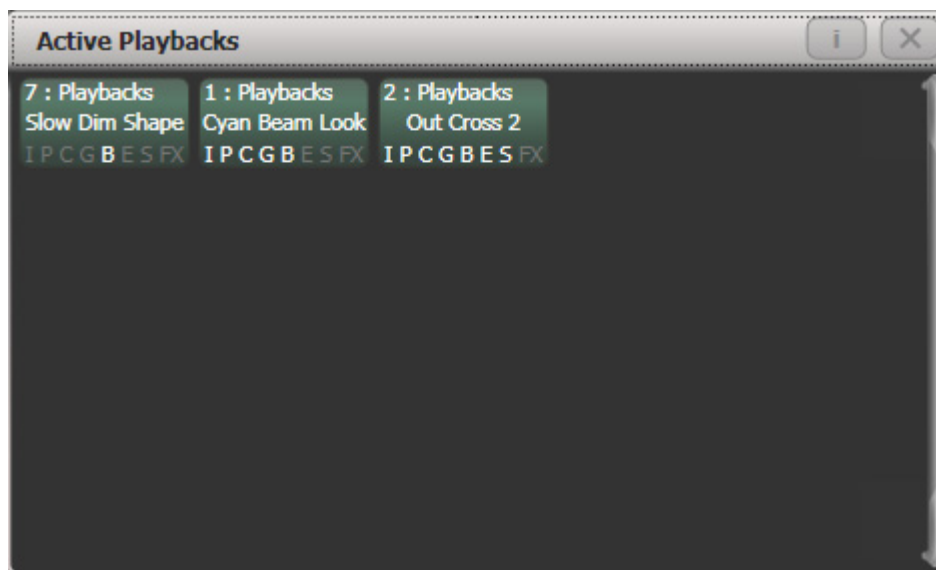

Click on a playback to instantly kill it. You can also press [Playback Options] followed by the playback in this window to change parameters of the playback.

8.2.5 SPEED AND SIZE MASTERS

Playbacks can be assigned to Speed and Size Masters which allow you to modify the speed and size of shapes or effects stored in a cue using a separate master fader (or in the case of chases, to modify the speed of the chase). This is really useful to modify the look when several playbacks are running at the same time.

You can also assign the fader of the playback the effect is stored in to control shape speed or size using the Playback Options – Fader settings, see section 8.7.3 on page 222.

Speed and Size Masters are described in detail in section 13.1.4 on page 284.

8.2.6 RELEASING RUNNING PLAYBACKS

You can release a running playback to its previous state by pressing <Release> (<Off> button on Pearl Expert), then the select button of the playback to be released. Channels will release back to their state in the previous playback until no playbacks are left to be released. If the [Release to Home] setting on the Release menu is Enabled, channels will go to the power-on state, which you can program (see next section). If the option is disabled, channels will remain in the state of the last playback. You can release all running playbacks by pressing <Release> then [Release all playbacks].

You can also configure the key profile so that the blue or grey buttons can be used to release the playback.

Channels will always release with a fade time, this defaults to 2 seconds but you can change it using [Master Release Time] in the Release menu. You can also set an individual release time for the playback from the Release tab of Playback Options.

- You can instantly kill a playback by pressing <Avo>+the swop button of the playback.
- You can set a mask so that only certain attributes release from the playback when the playback is killed. This uses the [Release Mask] option in the Playback Options menu (see section 8.7.5 on page 222). Normally all attributes will remain in the state last used in the playback – for cues which trigger strobing or other effects this might not be what you want.

8.2.7 RELEASING A WHOLE PAGE OF PLAYBACKS

You can use the Release function to release a whole page of playbacks in one operation. Press <Release> then the <Goto Page> button, or touch the current page in the playbacks view. You will get the following options:

[Release this Page]: releases all active playbacks on the current page and playback fader group

[Release Playbacks Not On This Page]: releases any active playback on the same fader group from another page

[Release All Playbacks In This Group]: releases any active playback in the fader group.

“Fader Group” refers to a particular area of the console, for example the main faders below the screen on a Tiger Touch or the top row on the left hand side of the Arena.

8.2.8 RELEASE MASK - RELEASING INDIVIDUAL ATTRIBUTES

You can release individual fixtures or attributes, and remove fixtures from shapes in playbacks using the release mask. There is a Global release mask which affects all release operations, or you can set a Local release mask which affects only the current playback.

Global release mask

If no local release mask is set for the playback, attributes release according to this mask. The default is for no attributes to release.

To set the mask, press <Release> then [Global Release Mask]. The softkey shows which attributes are enabled.

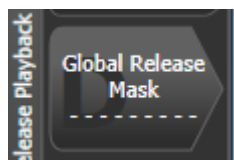

Local release mask

To set the local release mask for a playback, select [Playback Options] and press the select button of the playback. Then press [Release Mask]. If the option is set to [Mask Source Global] then press the option again to change to [Mask Source Local].

8.2.9 PROGRAMMING THE RELEASE / POWER ON STATE

You can program the state which fixtures will go to at power on, or when all playbacks are released. It can be useful to program this as a general lighting state so that there is some light on the stage when the console powers up, or when all playbacks are released.

The release state can be programmed in Shared mode or Individual mode. In Shared mode you just have to set the desired state for one of each type of fixture, and that state will be used for all fixtures of that type. In Individual mode, the state of each fixture will be recorded individually as you have set it.

- 1> Set up the look you want.
 - 2> Press <Record>, then <Release>.
 - 3> Select [Shared values] or [Individual values].
 - 4> Press the [Record] softkey.
 - 5> The Release state is saved.
- To test, fire some playbacks, then release them by pressing <Release> followed by the select button of the playback. The fixtures should return to your programmed release state.

8.2.10 AUTO RUN PLAYBACKS ON POWER UP

You can configure one or more playbacks to automatically run when the console is powered on. This can be very useful for unattended applications to set up an initial lighting state, or to run lamp on macros.

The Run On Startup option is found in the Playback Options for each playback. There is also a global user setting in the to enable or disable running playbacks on startup, which provides a way to turn off all startup playbacks rather than having to go and edit each playback..

- 1> At the top level menu press [Playback Options] then the Swop button of the playback you want to run
- 2> Select [Playback] category.
- 3> Set the [Run On Startup] option to Enabled.
- 4> The Release state is saved.

Power on playbacks show a Power symbol watermark in the playback information area above the fader. If you open the Show Library window (see section 3.7 on page 77) there is a filter tab to Show Startup Playbacks which allows you to list all the playbacks which are set to run on startup.



8.2.11 TURNING OFF INDIVIDUAL FIXTURES

You can turn off individual fixtures or certain attributes of them using the Off menu. This will cause the attributes/fixtures to release to their previous state before the playback was fired.

Press <Off> button followed by a playback to open the 'Off Playback with Mask' menu. Select the fixtures to be turned off, set mask as required and then press [Off] to turn the fixtures/attributes/shapes off.

On Titan consoles that do not have separate <Release> and <Off> buttons, pressing <Off> followed by a playback will release it which is not what you want. On these select the softkey [Off Playback Values] then select the playback.

8.3 PLAYBACK GROUPS

Playbacks can be linked in groups. Playback groups are useful if you want to have a set of mutually exclusive playbacks where only one in the group is active at any one time – if you fire a second playback from the group, the other playbacks in the group will be automatically killed.

On a console with motorised faders, the faders for the killed playbacks will return to zero. Otherwise the LED in the playback's select button will go out to show that the playback is now inactive.

8.3.1 CREATING A PLAYBACK GROUP

First open the Playback Groups workspace by pressing [Open Workspace Window] then use the [Next] button (or text search box) to select [Playback Groups].

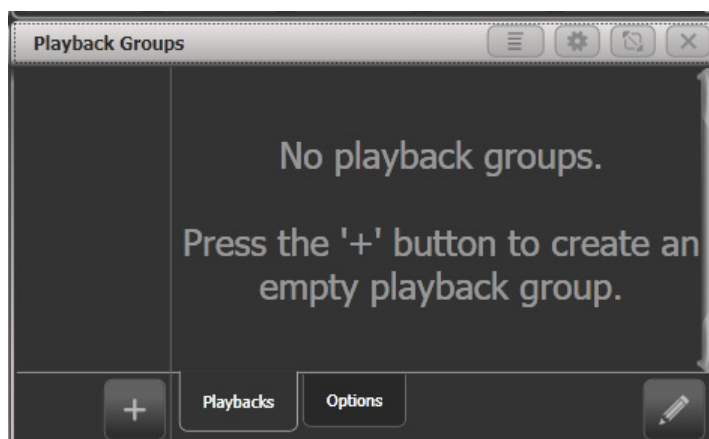

- 1> Press the + button. This creates a new empty playback group in the left pane.
- 2> Press the new group button (if this is your first group it will be [Playback Group 1])
- 3> Press the Pencil/edit button at the bottom right of the window to place the group into edit mode.
- 4> Select the playbacks to include in the group by pressing their select buttons once. The playbacks will appear in the workspace as you select them.
- 5> Press <Exit> when you have finished adding playbacks.

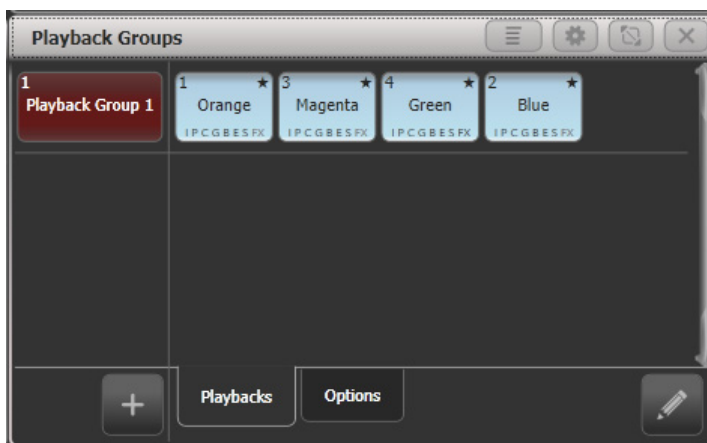

- The playback selection toggles while in edit mode so you can remove a playback by pressing its select button again. You can also remove a playback by pressing its button in the groups window while in edit mode.
- You can also create a playback group using the <Group> button – press <Group>, [Playback Groups], [Record playback group]. Then select the required playbacks which will highlight, then press [Store].
- You can set the legend or halo for a playback group by pressing the [Set Legend] softkey then the group button in the left pane of the workspace.
- You can fire playbacks (when not in edit mode) by pressing the playback buttons in the Playback Groups window.

When a playback is part of a group, an asterisk * is shown at the end of the playback legend to help you remember which playbacks are in groups.

8.3.2 EDITING WHICH PLAYBACKS ARE IN A PLAYBACK GROUP

From the Playback Groups workspace, select the group to be edited on the left then press the pencil/edit button bottom right to edit it.

The playbacks in the group highlight and you can toggle them in and out of the group using their select buttons.

There are also softkeys to set the User Number and Legend for the group.

- To delete the entire playback group, press <Delete> then the group button in the left hand pane of the workspace.

8.3.3 PLAYBACK GROUP OPTIONS

For each group you can set how playbacks in the group will behave. From the Playback Groups workspace, select the group to be edited on the left then press the Options tab at the bottom of the workspace.

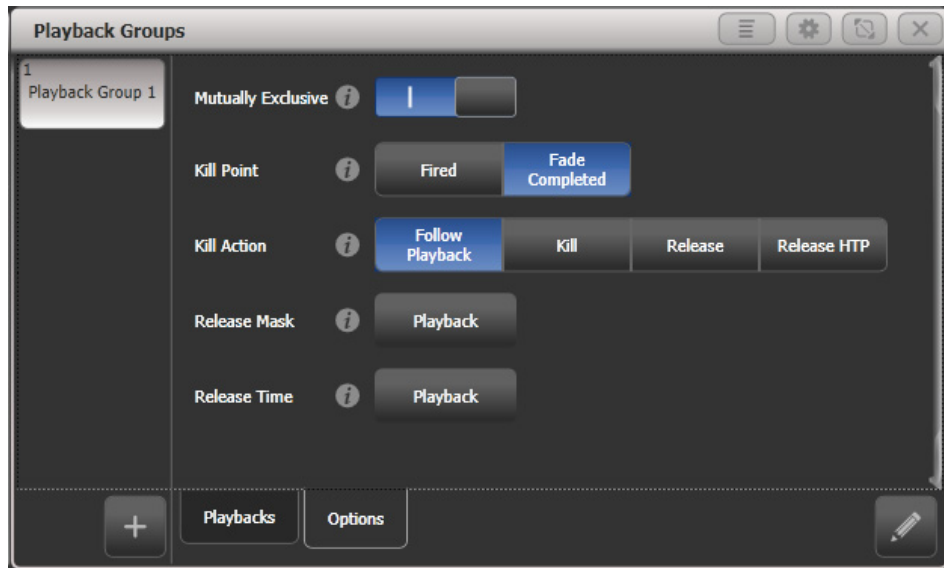

- Mutually Exclusive switches the exclusive mode on and off. This allows you to temporarily disable the exclusive action of a group without deleting the group.
- Kill Point sets when other playbacks in the group will be killed when you fire a new playback:
 [Fired] - as soon as the playback passes the trigger point
 [Fade Completed] – when the new playback has completed its fade in time.
- Kill Action sets whether the playbacks being killed will use Release rules or not.
 [Follow Playback] - each killed playback uses its own settings for release.
 [Kill] - playbacks are always killed without any release.
 [Release] – playbacks are always released using the settings in the mask and time below
 [Release HTP] – HTP channels are released but LTP channels are killed,
- Release Mask, Release Time allow you to override the release settings for killed playbacks. If set to the default of [Playback] then the playback's own settings are used.

8.3.4 PLAYBACK GROUP WORKSPACE DISPLAY OPTIONS

Using the workspace options menu (cog button at the top of the window) you can set three different display modes for the Playback Groups workspace:

[View Mode All] – 2 panes with group buttons on the left and all the playbacks in each group shown on the right



[View Mode Single] – 2 panes with group buttons on the left, but only the playbacks in the currently selected group are shown on the right. Handy if you have groups with a lot of playbacks in each one.

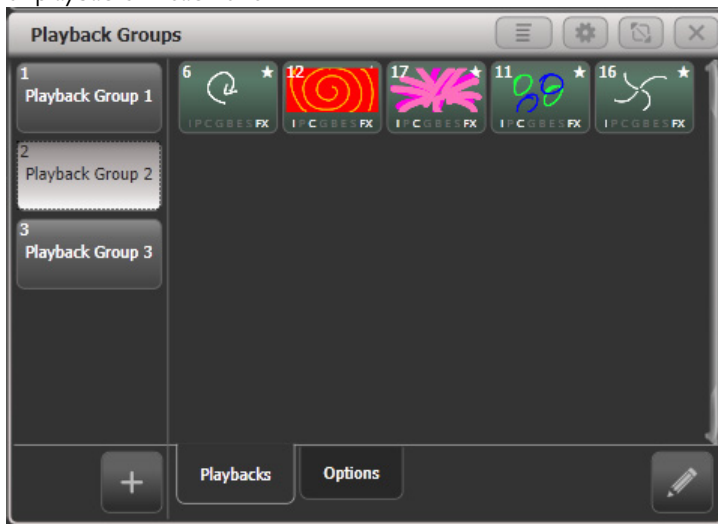

[View Mode Playbacks Only] – Single pane with just the playbacks for each group shown.

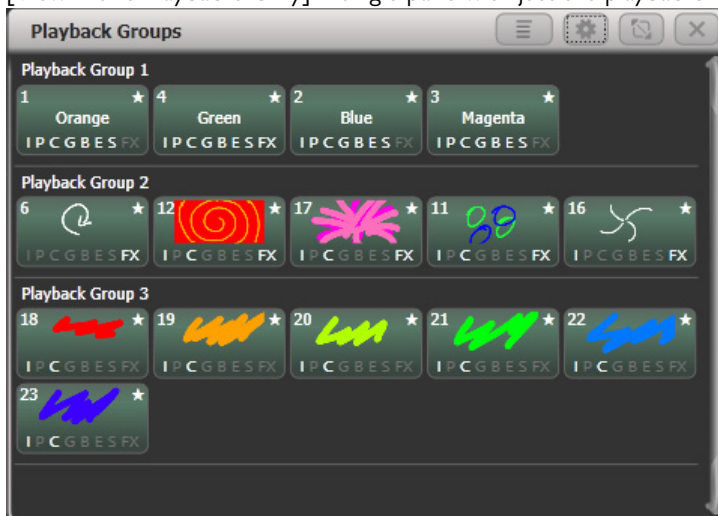

8.4 EDITING CUES

8.4.1 EDITING A CUE BY MERGING

You can edit any part of a cue you have already saved simply by making the changes and saving the new information on top of the cue.

- 1> Press <Clear> to empty the programmer.
- 2> Fire the cue you want to edit, so you can see what you are doing. Kill all other cues to avoid confusion.
- 3> Select the fixtures you want to change, and make the changes.
- 4> Press <Record>.
- 5> Press the Swop button for the cue you are editing.
- 6> Press [Merge] (the cue being edited is highlighted on the screen).
- 7> The console will merge the existing cue with your changes. Unchanged information is not affected.

- If you want to overwrite the cue entirely, use the option [Replace] at step 6 – but remember that unless you are in “Record by Stage” mode, any fixtures you haven’t changed won’t be saved.
- To speed up editing, you can set the console to “Always Merge” the cue. This option is set in the Handles tab of User Settings (press <Avo> and select [User Settings]).
- You can also press the Swop button for the cue a second time to select the “Merge” option (quicker than selecting the softkey Merge option).

8.4.2 UPDATING STORED VALUES AND PALETTES USED IN A CUE

If during a show you need to quickly update a cue, or a palette used in a cue (for example you fire a green cue and the fixtures turn out to be not quite the right colour) the Update function lets you quickly update either the cue itself or the palettes used in the cue.

For instant update of a fired cue, change the fixture settings and press Update twice.

- 1> With the cue fired, select the fixtures and change them to the settings you want to store (e.g. the right green colour).
- 2> Press <Update> (on consoles without an Update button press <Record Cue>, [Update]).
- 3> Press <Enter> to immediately store the new values to the cue.
Alternatively, the softkeys show a list of palettes and playbacks which can be updated. Select or deselect these as required.
- 4> If you have used the softkey options, press <Enter> to complete the update.

- You can also select which palettes will be affected by pressing the palette’s button twice.

- If you manually set an attribute in the cue which was set by a palette, then press <Update> <Update>, the palette will be removed from the cue. If you want to update the palette, use the softkey options or press the palette button.
- If you change an attribute using a different palette, the new palette will be stored instead.

8.4.3 PLAYBACK AND CUE VIEW

To see the current timings of the cue, touch the playbacks display for the fader, or press <View/Open> then the swop button of the playback you want to view. The screen will show details of the delay, fade, overlap and curve settings for the cue. You can touch each item to enable editing.

If a shape or pixel map effect is stored in the cue, you can view or edit the effect by clicking the button in the appropriate column.

The Effect Speed column allows you to set a multiplier or divider for the speed of effects in the cue.

The Times button on the left removes some of the columns, showing only timing related information.

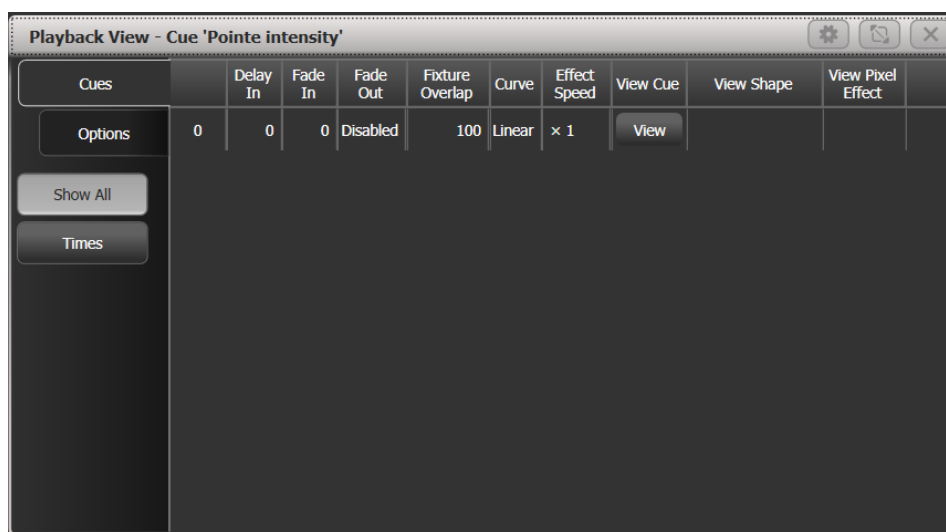

You can configure which columns are shown in the Playback View using the [Edit Columns] context menu button. Once you have set a view you can save it to a filter button which appears below the Times button on the left.

- 1> Press [Edit Columns] on the context menu.
- 2> Using the softkeys, enable or disable the columns to get the view you want.
- 3> Press <Record>. An [Add] button will appear at the bottom of the screen.
- 4> Press the [Add] button to create a filter button for this view.
- 5> You can set a legend and colour halo for the filter button using the normal [Set Legend] function.
- 6> You can delete filter buttons by pressing <Delete> then the button.

If you touch the View button at the right hand end of the row or the [View Cue] context button, the Cue View window opens, showing you details of the settings individual timings for all the fixtures in the cue.

The Cue View has four different views: Levels, Palettes, Times, Shapes. Views are selected using the context buttons to the left of the menu buttons.

- The **Levels** view shows the individual attribute values for each fixture.
- The **Palettes** view shows which palettes have been used to record the cue. Palettes are shown by their legends. Where an absolute value was saved rather than a palette, the value is shown instead. Again you can edit or remove the values.
- The **Times** view shows individual attribute timings for fixtures. If global timings are set, no times are shown in the cue view.
- The **Shapes** view shows which attributes of each fixture are running shapes.

Cue View - Red Beam Look																
Attributes		Number	Order	Dimmer	Shutter	Pan	Tilt	Colour Macros	Colour Func	Colour	CTO	White	Cyan	Red	Magenta	Green
All	I	Robin600ES	101	1	100	Open	46.02	23.66		Fixed	Open	0		0		0
P	C	Robin600ES	102	2	100	Open	48.68	23.66		Fixed	Open	0		0		100
B	E	Robin600ES	103	3	100	Open	51.32	23.66		Fixed	Open	0		0		0
	S	Robin600ES	104	4	100	Open	53.98	23.66		Fixed	Open	0		0		100
Fixture Type		Robin600ES	105	5	100	Open	46.02	23.66		Fixed	Open	0		0		100
All Fixtures		Robin600ES	106	6	100	Open	48.68	23.66		Fixed	Open	0		0		0
BB#		Robin600ES	107	7	100	Open	51.32	23.66		Fixed	Open	0		0		100
Robin 600 LED Wash		Robin600ES	108	8	100	Open	53.98	23.66		Fixed	Open	0		0		0
Robin 600E Spot		Robin600ES	109	9	100	Open	46.02	23.66		Fixed	Open	0		0		0
		Robin600ES	110	10	100	Open	48.68	23.66		Fixed	Open	0		0		100
		Robin600ES	111	11	100	Open	51.32	23.66		Fixed	Open	0		0		0
		Robin600ES	112	12	100	Open	53.98	23.66		Fixed	Open	0		0		100
		Robin600ES	113	13	100	Open	46.02	23.66		Fixed	Open	0		0		100

Filter which attributes you are shown using the All/IPCGBES buttons in the top left corner.

Filter which fixtures you are shown using the fixture type buttons on the left.

You can edit or remove one or more individual control values in the cue:

Touch or drag over the required control values in the grid to select them – they will be highlighted in blue.

The softkeys then give you available settings for that control value, or you can directly edit values by typing numeric values and pressing enter.

You can delete the selected control(s) using the [Delete] softkey.

You can turn attributes On and Off using the <Off> button and the [On] softkey. Off temporarily removes a value from the cue, it can later be restored using [On].

You can remove a fixture completely from the cue by selecting the fixture then pressing the [Remove Fixtures] softkey.

Any changes take immediate effect.

- The context menu option View Tracking Values allows you to highlight in grey values which are tracked from previous cues.

8.4.4 USING PARTS OF EXISTING CUES - THE INCLUDE FUNCTION

The Include function lets you load selected parts of a cue back into the programmer. (Normally, only manual changes to fixtures are put in the programmer). You can then use this to make a new cue. This is useful if you want to make a cue which is similar to one you already have, or to build a new cue from various parts of other cues. It's also useful when editing shapes in cues.

There are two modes, Quick Include and Advanced Include. Quick Include simply reloads the whole cue. Advanced Include allows you to specify which attributes of which fixtures you want to load into the programmer. So, for example, if you have a cue which contains position, colour and gobo information for 8 fixtures, you can use the include function to load only the colour information for 4 of the fixtures into the programmer. You could then Include position information from another cue into the programmer, and build up a new cue using information from several existing cues.

If you Include a chase or cue list, the screen shows you a list of the cues within it, and you select the one you want to Include using Wheel A or by touching the cue. You can also type in the cue number to Include.

- 1> Press <Include>.
 - 2> Press [Quick Include] or [Advanced mode] if you want to change the mode.
 - 3> Press the Swop button of the cue you want to include into the programmer. If you are in Quick Include mode, this Includes the cue and finishes.
 - 4> If you are in Advanced mode, all fixtures in the cue will be selected. If you don't want them all, deselect the fixtures you don't want. The fixtures in the cue are highlighted on the screen and on the fixture buttons.
 - 5> Use [Set Mask] or the Attribute Bank buttons to select which Attributes you want to include (All are included by default – Softkey C turns them all off and D turns them all on). Softkey E lets you include or exclude Shapes from the cue.
 - 6> Press <Enter>. The selected attributes of the selected fixtures will be loaded into the programmer.
 - 7> Repeat from 2 to include other attributes from the same fixtures, or repeat from 1 to include other fixtures.
- In Quick Include mode, you can set a mask for the include by pressing one or more of the attribute bank buttons before you select the cue to include.

8.4.5 REMOVING ATTRIBUTES FROM CUES USING “OFF”

The <Off> button allows you to remove an attribute which has been stored in a cue, as if you'd never recorded it.

For example, suppose you recorded a cue which had fixtures at a certain position, with the colour set to green. If you later decide that you don't want a colour recorded at all in the cue, so that the playback will position the fixtures but leave the colour set by previous playbacks, you set the colour values to Off in the programmer, which when saved will remove those values from the cue. You can also use the Off function to remove complete fixtures from a cue.

Setting an attribute to Off is not the same as recording an attribute at zero, since this would change the attribute when the cue was fired. It is the same as excluding that

attribute using the mask when recording, so the attribute will remain unchanged when the cue is fired.

- 1> Press <Off>, then [Off Playback Values] followed by the playback to be changed.
- 2> All fixtures in the playback will automatically select. If you only want to change some fixtures to Off, change the selection.
- 3> By default the attribute mask is set so all attributes will be changed to Off. Press [Set Mask] to choose which attributes will be set to Off.
- 4> Press the [Off] softkey.

You can also use Include to set values to Off.

- 1> Use the Quick Include function (described in previous section) to load the cue you want to change into the programmer.
- 2> Press <Off> to display the Off menu.
- 3> All fixtures in the cue will be selected. If you don't want to change them all, deselect the fixtures you don't want.
- 4> Use the Attribute Bank buttons to toggle which attributes you want to change. Then press the [Attributes Off] softkey to set them to Off. The bottom softkeys also give options such as [Dimmer Off].
- 5> Press <Record>, then set the record mode to [Replace], and press the Swop button of the cue to update it.

- To turn off all attributes of all selected fixtures, press <Off> then [Selected Fixtures Off].
- You can merge "Off" attributes into a cue without including it first.
- You can also remove attributes from palettes using the Off function.
- Another way to remove attributes is from the Cue View window. See section 8.4.3 on the previous page.
- Attributes set to Off can be restored to their previous value using the On function. Set the attribute to On and merge it into the cue.

8.5 COPYING, MOVING, LINKING AND DELETING

8.5.1 COPYING OR MOVING A CUE

Using the <Copy> button you can make a copy of an existing cue, move it to a new playback, or create a new playback which is linked to the existing playback. You can copy, move or link multiple playbacks (which may be cues, chases or cue lists) in one operation.

Move is useful for tidying up the console. Linked cues are handy if you want a cue to appear on more than one page for ease of operation; also the linked cue can have different timings and playback options from the cue it's linked to.

- 1> Press <Copy>.

- 2> Select [Copy], [Move] or [Link]. Pressing <Copy> again will also toggle these options. Some consoles have a <Move> button to get straight into Move mode.
 - 3> Press the select button of the cue you want to copy/move/link. You can select a range of playbacks by holding the first button while pressing the last in the range, or use the <Thro> and <And> buttons to add more playbacks to the selection – hold down <And> to keep adding them.
 - 4> Press the empty select button where you want it to go.
- The <Menu Latch> button latches the Copy/Move/Link menu, so you can keep copying, moving or linking things without having to keep pressing the button. The latched menu will stay active until you press <Menu Latch> to unlatch it.
 - [Retain Layout] or [Bunch Up] is used when copying a group of cues with empty playbacks in the group – you can either keep the empty playbacks, or bunch up the used playbacks together.
 - When in Copy mode, option [Copy Legends] can be changed to [Don't copy legends] so that the copied cues are given default legends.
 - When in Move mode, [Swap Items if Required] will attempt to reposition any existing playbacks which are in the way of the move. This is useful when rearranging playbacks on a page which is nearly full.

8.5.2 DELETING A CUE

To delete a cue:

- 1> Press the <Delete> button.
 - 2> Press the select button of the cue you want to delete.
 - 3> Press the select button again (or press <Enter>) to confirm the delete.
- Instead of deleting the cue you can select [Unassign], this will remove the cue from the handle but retain it for future use. Go to the Show Library to reuse unassigned cues.
 - Press <Menu Latch> to keep the delete mode active. You can keep deleting using steps 2 and 3 without having to keep pressing the Delete button. Press <Menu Latch> to leave latched delete mode.

8.6 CUE TIMING

The console allows a wide variety of timing functions to be set for each cue.

8.6.1 SETTING FADE TIMES AND OVERLAP FOR A CUE

When programming a cue, you can set a delay, fade in and fade out time for each attribute of each fixture, or globally for the cue. Shapes in the cue will also be affected, depending on the fade mode.

If you enter times more than 60 seconds, Titan will automatically split the time into minutes and seconds, for example enter 115 to set 1:15 (1min 15 seconds). Entering more digits will set hours, minutes, seconds.

You can delay the fade times between fixtures in a cue so that the cue is applied sequentially to each fixture. This is called Fixture Overlap and can create some amazing “peel off” or “roll” type effects with no programming at all.

In the diagram below, the top picture shows how the LTP channels change when used with delay, fade and fade out times. The second picture shows how the HTP channels change. The third and fourth pictures show what happens to the LTP channels when fixture overlap and attribute fade are used.

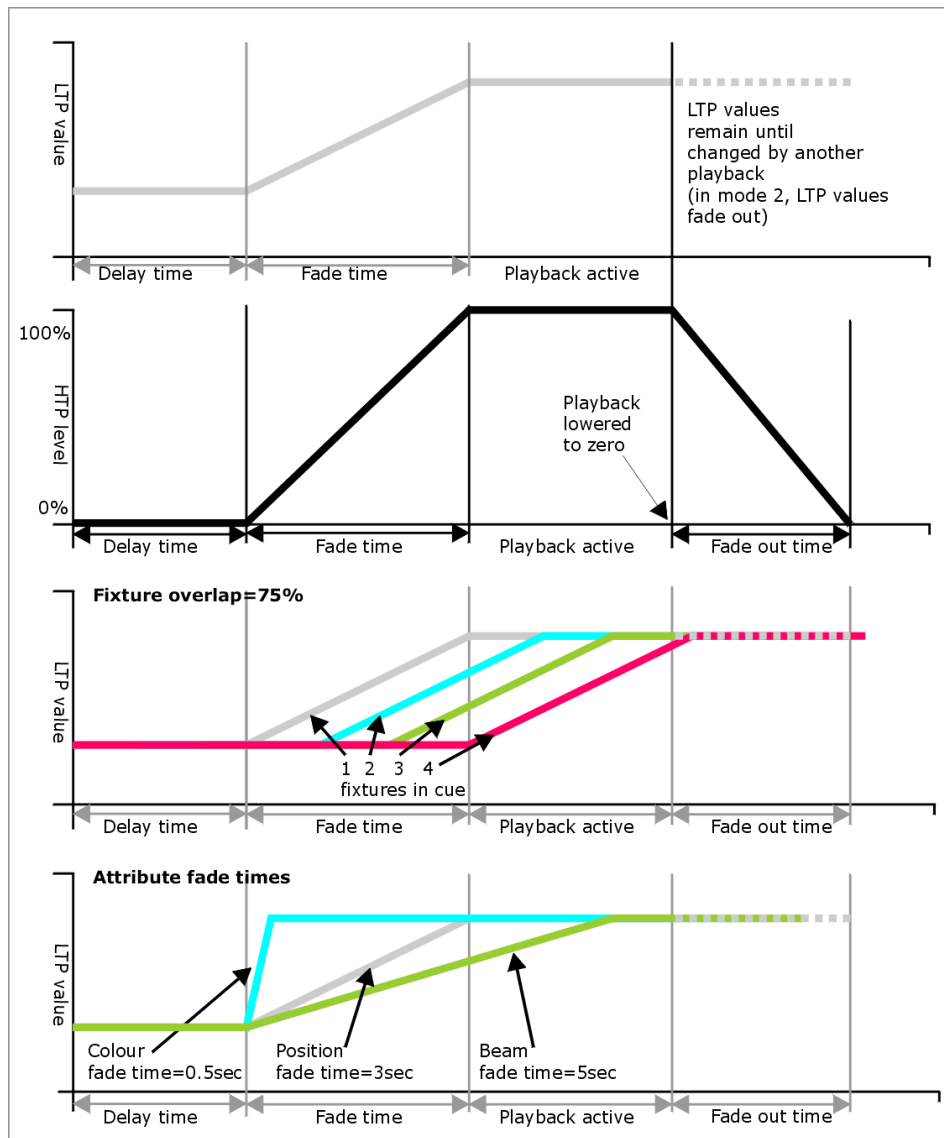

All times which you have set while programming the fixtures/dimmers will be recorded when you save the cue.

You can also edit times of a cue you have already saved like this:

- 1> Press [Edit Times] at the top level menu.
- 2> Press the Swop button of the cue.
- 3> Press [Fade Mode x] to set the cue mode. This sets how the times are used, see below.

- 4> Press [Delay time] to set the delay before the cue starts, [Fade time] to set the fade-in time of the cue, and [Fade out time] to set the fade-out time of the cue.
 - 5> Type the new time (in seconds) using the numeric keypad and press <Enter> to save it.
 - 6> Press [Fixture Overlap] to change the overlap, then enter 0-100 on the keypad. 100% means all fixtures fade together. 0% means that the first fixture will finish its fade before the next one starts. 50% means that the 2nd fixture will start fading when the first one is half way through its fade. The order of the fixtures is set by the order you selected them (but you can change this, see section 8.6.2).
 - 7> Press <Exit> to get out of Edit Times mode.
- You can also set independent times for the IPCGBES attribute groups, and for each individual attribute, see next section for details of this.
 - You can quickly set times from the keypad using the <Time> button, e.g. <Time> 5 <And> 2 sets 5 sec fade in and 2 sec fade out. (The Time button is the button previously labelled Set on Titan Mobile and Sapphire Touch, and Next Time on Tiger Touch and Pearl Expert).

The times you enter are affected by the cue mode which is set using the [Fade Mode] option. This option can also be set from Playback Options Fader Mode:

- Mode 0 – Channels will fade in as set by the fade time. The Fade Out time is ignored. If times are set to zero, the HTP channels fade in with the 0-100% position of the playback fader and the LTP channels will snap.
- Mode 1 - Channels fade in as set by the fade time. HTP channels fade out as set by the fade out times (LTP channels remain as set in the cue). If times are set to zero, the HTP levels will fade in and out with the fader and the LTP channels will snap when the cue is fired.
- Mode 2 – Channels will fade in as set by the fade time. The Fade Out time is ignored. However, the fade will stop when the fader position is reached, so if the fader is set to 50%, the attributes will stop half way to their programmed position. You can reverse the fade back to the original position by moving the fader back. If times are set to zero, both HTP and LTP channels are controlled by the fader position.
In this mode LTP channels revert to their previous settings when the cue is deactivated.
Mode 2 is useful when used with a pan/tilt cue for manually tracking a spot across a stage or down a catwalk using the fader position, or for colour mixing using RGB fixtures.
- Mode 3 - Crossfade cue. All channels, including intensity channels, will fade to the settings in the new cue. All other cues fade out and all other active playbacks become inactive; if you need to re-fire a playback, take the fader to zero and put it up again.
- If the cue includes shapes, then the shape will change with fade times. The changes will be timed for a Mode 1 cue and controlled by the fader position for a

Mode 2 cue. This allows you to create a shape which gets bigger or faster as you push up the fader.

8.6.2 CHANGING FIXTURE ORDER

You can change the order of the fixtures stored in a cue. Normally this is set to the order in which you selected the fixtures when the cue was created, but you might want to change this (for example to pair up fixtures so they move together when using Overlap).

- 1> Press [Edit Times] at the top level menu.
- 2> Press the Swop button of the cue to be changed.
- 3> Press [Fixture Order].
- 4> Set the sequence number to start from using option A.
- 5> If you want the sequence number to increase automatically, set [Autoincrement] to On. If you want some fixtures to have the same sequence number, set it to Off.
- 6> Touch the Select buttons of the fixture(s) you want to place in that position in the sequence. The sequence number is shown in the top right hand corner of the fixture select touch buttons.



- 7> Press <Exit> to finish.

- You can set several fixtures to have the same sequence number. This means, for example, when used with Overlap they will all do the same thing at the same time.
- You can remove a fixture from the sequence by turning off [Autoincrement] and pressing the fixture button twice. The fixture sequence will show X. Touch the button again to put it back in the sequence.

8.6.3 SETTING ATTRIBUTE FADE TIMES FOR A CUE

You can set individual fade times for each attribute group (such as Position). If you set a time, it overrides the normal times.

To set an attribute group fade time:

- 1> Press [Edit Times] at the top level menu.
- 2> Press the Swop button of the cue to be changed.
- 3> Press the Attribute Bank button (right hand side) for the attribute you want to change.
- 4> Press [Delay] to set delay time or [Set fade] to set fade time.

- 5> Type the new time using the numeric keypad and press <Enter> to save it, or press [Use Global] to delete the attribute times and go back to the normal times.
- 6> Press <Enter> to save the changes.

You can take this even further and set individual fade times for each fixture. When you select the cue to be changed, you will see that all the fixtures in the cue are selected. To set attribute times for only certain fixtures, change the fixture selection using the Swop buttons.

The Cue View window will display when editing cue timings to help you see what you are editing. You can touch fixtures or attributes in the grid to select which items are going to be edited.

Press the <All> button to select all fixtures in the cue.

When you are in the Set Attribute Times menu you can only select fixtures which are in the cue you are editing.

8.6.4 EDITING TIMES IN THE PROGRAMMER

You can check and edit the times which are set in the programmer before saving a cue. You can also set times into the programmer and merge them into cues as a quick way of updating times, just like you would with attribute values.

Press the <Time> button to access this menu.

- On Titan Mobile and Sapphire Touch, the Time button is the key above Clear (previously labelled <Set>). On Pearl Expert and Tiger Touch it is the key previously labelled <Next Time>.

The menu allows you to set cue times, or times for all attributes of a fixture, attribute groups or individual attributes.



Using the <Time> button there are various quick shortcuts to setting times.

- TIME 5 = 5 sec fade in.
- CUE 3 TIME 5 = 5 sec fade in on connected playback's cue 3.
- TIME FIXTURE 5 – 5 sec fade in for all attributes of selected fixtures.
- TIME FIXTURE G 5 – 5 sec fade in for gobo attribute group of selected fixtures.
- TIME FIXTURE @B 5 – 5 sec fade in for attribute connected to wheel B on selected fixtures.
- 5 @ 3 – 5 sec fade in, 3 sec delay.
- 5 AND 2 – 5 sec fade in, 2sec fade out.
- 1 THRO 10 - times spread across fixtures according to selection order.

Individual attribute times can also be set from the wheels, using the [Wheels] softkey option on the root menu.

Using the <Options> button while showing the times allows you to set the Speed, Effect Multiplier, Speed Multiplier and speed source in the programmer. Speed and Speed Multiplier would only do anything if you create a chase and would have no effect in a cue.

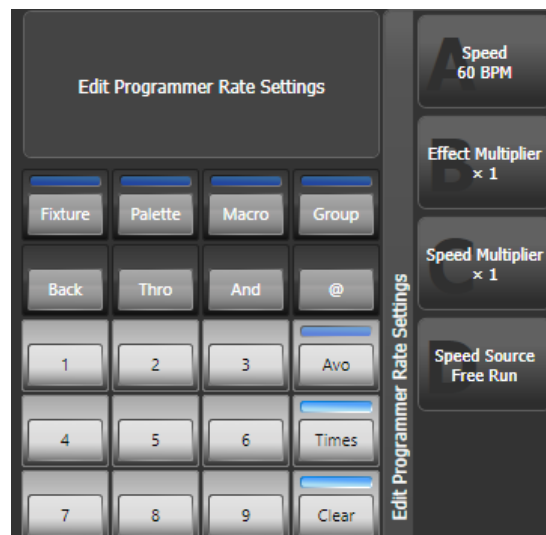

8.7 PLAYBACK OPTIONS

To set options for a cue, chase or cue list, press [Playback Options] on the root menu, then press the select button of the playback to be edited. A list of option categories will open on the softkeys; a window will also open giving a touch-friendly version of the playback options.

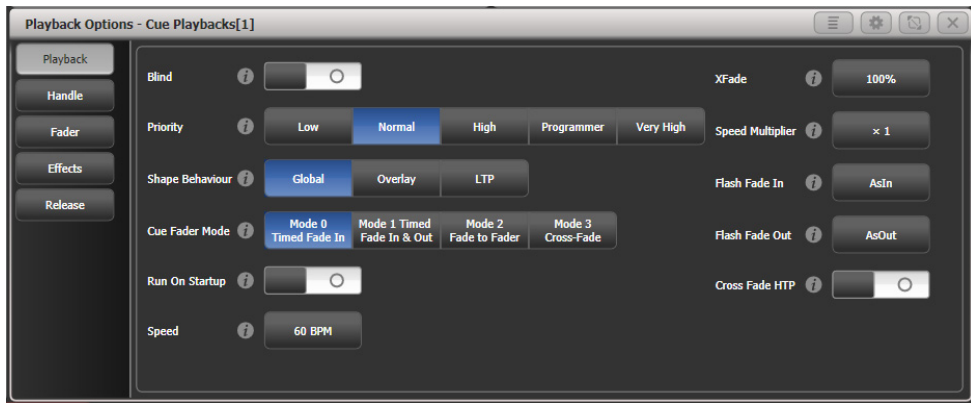

Click on the  button for a help window on each setting.

You can select multiple playbacks if you want to set the options the same on all of them. The current option settings will be shown if they are the same on all playbacks.

8.7.1 PLAYBACK OPTIONS – PLAYBACK TAB

Blind: Sets this individual playback to Blind mode. The playback will then output only to Visualiser, not to the stage. This can be very useful if you need to program and test a cue during a live show.

Priority: allows you to configure how playbacks will behave if you turn on two playbacks controlling the same fixture. The priority can be set to Low, Normal, High, Programmer or Very High. (Programmer gives the same level as manually set attributes in the programmer). If a fixture is being controlled by a playback and you turn on a playback of the same or higher priority, then the new playback will take over. However, if the new playback is set to lower priority than the first playback, the fixture will not change.

This is useful if, for example, you've programmed looks using all your fixtures, then you decide you want a couple of them to spotlight a singer. If you set the Spotlight playback to be high priority, then while it is active no other playback will affect the spotlight fixtures.

Priority is useful when using Swop buttons for strobe-type effects where you want to black out everything else. If you have a position shape running on other fixtures, you don't want that to stop during the Swop, or it will look messy when you release the Swop button. So set the shape playback to have a higher priority than the strobe playback, and it will keep going during the strobe and continue smoothly when you release the Swop button.

- Attributes set by manually applying a palette to a fixture will override all playback priorities except Very High.

Shape behaviour: Controls the behaviour of Key Frame Shapes in this playback.

Global – Use global setting from User Settings.

Overlay - Shape continues to run over changes to attributes

LTP – If attributes are changed, the shape will stop running on those attributes

Fader mode: This is the same option as set in the [Edit Times] menu.

Mode 0 – Channels fade in as set by the fade time. The Fade Out time is ignored. If times are set to zero, the HTP channels fade in with the 0-100% position of the playback fader and the LTP channels will snap.

Mode 1 - HTP channels fade in and out as set by the fade out times (LTP channels fade in but then remain as set in the cue). If times are set to zero, the HTP levels will fade in and out with the fader and the LTP channels will snap when the cue is fired.

Mode 2 – Both HTP and LTP channels follow the fader position. Useful when used with a pan/tilt cue for manually tracking a spot across a stage or down a catwalk using the fader position or for mixing colours on RGB fixtures.

Mode 3 - Crossfade cue. All channels, including intensity channels, will fade to the settings in the new cue. All other cues fade out and all other active playbacks become inactive; if you need to re-fire a playback, take the fader to zero and put it up again. Useful for setting a video playback state.

Run on startup: Sets this playback to run when the console powers on. This can be disabled by the Auto Run Startup Playbacks option in User Settings (turned on by default).

Speed: Default speed for this playback in BPM. This can be overridden by a Rate or BPM master, or if the playback is a chase, can be modified using the wheels.

Xfade: Default crossfade for this playback. If the playback is a chase, this can be modified using the wheels and the changes will be saved here.

Speed multiplier: Allows you to modify the speed, useful when running multiple playbacks together

Flash Fade In / Flash Fade Out: Sets the fade in/fade out time for this playback when it is fired using the flash button. By default these are set to “AsIn” and “AsOut” which will use the fade time set for the playback in the Times menu. This option allows you to set a different flash action for the playback. Note that the Key Profile for the flash button must be set to Timed Flash for this to work.

Cross Fade HTP: If on, makes the HTP (dimmer) channels in this cue override other HTP channels, obeying the priority settings. Normally if a dimmer channel was up in another cue, the highest dimmer setting would continue to be output, but this option lets you create a playback that will override this behaviour, so if you specifically need some fixtures to be at 50%, this option will let you do that.

8.7.2 PLAYBACK OPTIONS – HANDLE TAB

Handle paging: allows you to lock the playback on a handle so that it always appears on that handle no matter what page is selected. This is useful if you have some general playbacks you want on every page, without having to copy the playback onto each page. Unlocked – playback will change with the pages as normal

Transparent lock - playback will appear on all pages when the handle is unprogrammed

Locked – this playback will appear on all pages. Playbacks programmed on this handle on other pages will not be accessible.

Key profile: Sets the key profile individually for this playback. Global sets the key profile back to the global setting for playbacks.

8.7.3 PLAYBACK OPTIONS – FADER TAB

Fader mode: same as in Playback tab, see above

Shape size: sets whether the fader position affects the size of shapes in this playback

Fixed – no effect

Fader –size of all types of shape set by fader position

HTP fader – only dimmer shapes are controlled by fader position

Shape & effect speed: sets whether the fader position affects the speed of shapes in this playback

Curve: Allows you to set a different curve shape for this playback – curves are listed on the softkeys. The various curves are illustrated in section 16.6 on page 334.

You can also allocate a Speed Master to the cue which will allow you to modify the shape during playback, see section 8.2.4 on page 202.

8.7.4 PLAYBACK OPTIONS – EFFECTS TAB

Shape behaviour: same as in playback tab, see above

Speed source: Allows you to allocate a Speed Master to this playback. See section 8.2.4 on page 202.

Size source: Allows you to allocate a Size Master to this playback

Shape size: same as in fader tab, see above

Shape & effect speed: same as in fader tab, see above



If you have a cue which contains only shapes to overlay on other cues, set the cue to [Size on Fader] and allocate a Speed Master. You can then create lots of different looks out of the shape by varying the size and speed at show time using the playback fader and the speed master.

8.7.5 PLAYBACK OPTIONS – RELEASE TAB

Release Mask: lets you specify which attributes will be released to the state they were in from a previously fired playback when this playback is killed (you lower the fader to zero). You can also use the Attribute Bank buttons to set the mask.

The mask can be set to Global or Local. Local means you can make individual mask settings for this playback. Global uses the global release mask which is set in the Release menu (press Release).



Release mask is useful when creating a temporary strobe effect on a playback. Press [Release Mask] then the Intensity/Shutter attribute button. Now when you turn off the playback the shutter will release to its previous state and the strobe will stop.
When using with chases you need to press [Mask] before pressing the Intensity/Shutter button.

You can use Key Profiles to allocate one of the handle buttons to release the playback.

Release Time: Sets a release fade time for this playback. Enter blank time to return to global (Global release time is set in the User Settings).

9. CHASES

As well as being used to store static cues, the playback faders can also be used to store chases (sequences of cues). You can also store chases on touch buttons in the Playbacks window.

Chases can run once or repeat continuously. You can set individual fade time for each cue in the chase and unlink cues so that the console waits for you to press Go before the chase continues.

If you are programming patterns with a lot of fixtures, consider using Keyframe Shapes in place of chases, as they give you more facilities to vary the look.

9.1 CREATING A CHASE

9.1.1 PROGRAMMING A CHASE

To program a chase, you have to set up the look for each cue in the chase, then save it.

You can either set all the fixtures and dimmers manually for each cue in the chase, you can use Quick Build to create a state from palettes and cues, or you can use Include to load in cues.

- 1> Press <Record> then select [Chase]. (Some consoles also have a Record Chase button).
 - 2> Press the Swop button of the playback where you want to store the chase (you can also store chases on touch buttons in the Playbacks window).
 - 3> Set up the look for the first cue, either manually or by using "Include" on existing cues.
 - 4> You can change the number given to the step using [Step Number].
 - 5> Press the Swop button of the playback to store the programmer contents as a step of the chase. You can also press [Append Step] on the menu.
 - 6> Press <Clear> (unless you want to re-use the contents of the programmer), then repeat from step 3.
 - 7> Press <Exit> to finish when you have stored all the cues you want.
- [Record Mode] lets you select Record By Fixture (all attributes of any modified or selected fixture are saved), Record By Channel (only modified attributes are saved), Record Stage (all fixtures with a non-zero dimmer setting are saved), or Quick Build (see next section).
 - The cue number currently being saved, and the total number of cues, is shown on the top line of the display.
 - Press <Clear> when you have finished recording the chase, otherwise when you try to play it back the programmer will override the chase and you won't see the chase properly.
 - You can record shapes in a chase. If the same shape is saved in subsequent cues it will continue from step to step and if not it will stop at the end of the cue. (The shape is the same if you didn't press <Clear> after the previous step, and didn't

change the speed, size or phase of the shape from the previous step; or if you included the shape from the previous step and have not modified it)

- You can set a legend for the chase by pressing Set Legend, then pressing the Swop button for the chase and entering the legend, as with cues.
- There is no limit to the number of steps in a chase.

9.1.2 CREATING A CHASE WITH QUICK BUILD

Quick Build mode, as the name suggests, allows you to build a chase very quickly from existing palettes and playbacks.

Start recording a chase as described in the previous section, set [Record Mode] to Quick Build.

Select any palette or playback to insert that item as a step in the chase. If you select multiple palettes by selecting a range of buttons, each palette will be added as a separate step.

To insert specific fixtures from a palette or playback, select the fixtures first and then select the palette or playback.

9.2 PLAYBACK

9.2.1 PLAYING BACK A CHASE

To fire a chase, raise the fader of the playback. (You can also use the Flash/Swop buttons). The chase will start to run. The bottom line of the screen relating to the playback fader shows the current cue number and speed of the chase.

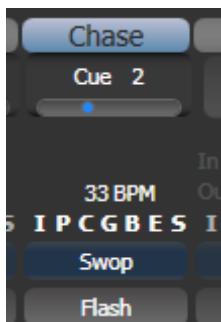

- The HTP (intensity) channels in the chase will be controlled by the fader; if fade times are programmed, the fade will stop at the fader level. The other channels (LTP) will be set as soon as the fader moves above zero according to the fade times programmed in the chase. You can set the point at which the LTP channels activate from the User settings menu.

- While the chase is running, the area of the screen above the wheels shows details of the chase steps.

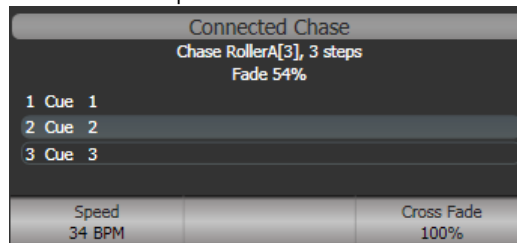

- You can temporarily pause the chase by pressing the Stop button near the wheels. Press Go to resume playback.

There are many options you can set to determine the way the chase runs and these are described in the rest of this chapter.

9.2.2 CONNECTING A CHASE FOR CONTROL

When you fire a chase, the wheels and Stop/Go buttons are automatically allocated to control the speed and crossfade of the chase – this is called Connecting the chase. If you have more than one chase running, you can choose which chase is connected to the controls using the <Connect> button.

- Connect a different chase to the controls by pressing <Connect> then the Swop button of the chase you want to control.
- Disconnect a chase from the controls by double pressing <Connect>.
- You can turn off the “Auto Connect” option in the User Settings/Wheels menu if you don’t want to connect to a chase when you fire it. You will have to use the <Connect> button to control the chase if you do this.
- There is a further option “Auto View on Connect” in the User Settings/Wheels menu which will automatically open the view window for a chase when you fire the playback. This is useful to keep the correct chase view open as you swap between chases.
- Normally if you change the speed or crossfade of a chase, the new setting is saved. However you can set this change to be temporary, so that when the show is reloaded the speed and fade will go back to the previously saved settings. Go to User Settings (<Avo> + [User Settings], in the Times tab set the option “Connected View Sets” to “Temporary Speed”. You can still save a temporary speed by pressing [Save Temporary Speed] in the Set Times menu.

9.2.3 SETTING SPEED AND CROSSFADE FOR A CHASE

The left wheel is assigned to control the speed of the chase it is connected to. The speed is shown in Beats Per Minute (BPM) on the display. You can also enter a speed from the keypad as described below. The last speed you set on the wheel is always remembered, you do not have to tell Titan to save it.

Crossfade is the “slope” between cues; with a crossfade of 0, the fixtures snap instantly to the next cue, but with a crossfade of 100, the fixtures spend the whole cue time fading to the next cue. With a crossfade of 50, the fixtures delay for half the cue time and fade for the other half of the time.

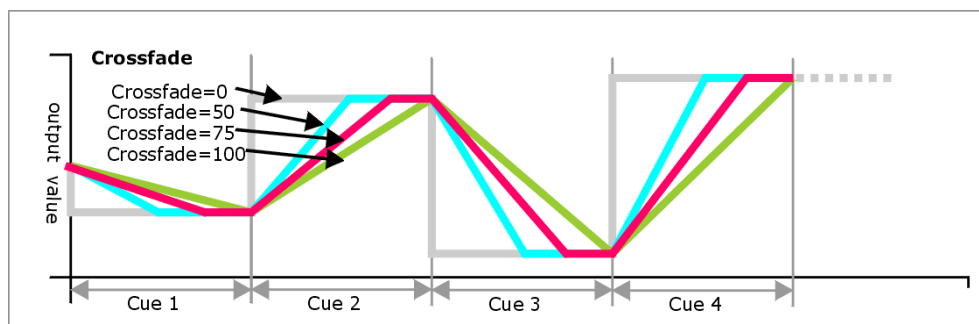

You set the crossfade and speed as follows:

- 1> Press [Edit Times] from the top level menu then the Swap button of the chase.
- 2> To set the crossfade, press [Xfade] and type the fade from 0 – 100. 0=no fade (the chase will “snap”), 100=max fade (the chase will move continuously from step to step).
- 3> To set the speed, press [Speed], type the new speed, then press <Enter>. The speed can be set in Beats Per Minute (BPM) or seconds depending on the User Settings.

There are other options you can set for the chase from this menu including Fixture Overlap, which are described in the Timings section 9.5.1 on page 231.

You can set individual times for each cue in a chase and unlink cues from each other so they wait for you to press the Go button. This is done using the Playback View, or the <Unfold> function which is described in section 9.3.2 on page 230.

You can select whether the chase speed is displayed in seconds or in Beats Per Minute (BPM). Press <Avo> and [User Settings], then press [Tempo Units] to set the option to [Tempo Units Seconds] or [Tempo Units Beats Per Minute (BPM)].

You can also allocate a Speed Master to the chase which will allow you to modify the chase speed during playback, see section 8.2.4 on page 202.

9.2.4 MANUALLY CONTROLLING THE STEPS OF A CHASE

You can pause a chase, if the chase is connected to the wheels, by pressing the Stop button next to the wheels. Press the red <Go> button to resume playback of the chase.

While the chase is stopped you can use the <Prev Step>/<Next Step> buttons (← and → on some consoles) next to the <Connect> button to move to the next or previous step. The programmed fade time will be used when moving between steps, unless you enable the user setting [Chase Snap], or press <Snap> button if the console has one.

You can also configure the blue and grey buttons of the playback handle to be Stop and Go. This uses the Key Profiles function.

- 1> Hold <Avo> and press [Edit Current Key Profile].
- 2> If you are using the default Key Profile which is not editable, you will be prompted to add a new profile.

- 3> Press [Chases] then choose either the Blue key or the Grey key.
- 4> Select Go or Stop from the list of functions. Then press <Exit> and set the function for the other key if required.
- 5> Press <Exit> to continue using the console.

9.2.5 CHANGING CHASE DIRECTION

The <Prev Step>/<Next Step> (← and → on some consoles) buttons next to <Connect> set the direction of the connected chase. If fitted, the ↔ double-ended arrow button sets bounce mode where the chase will run to the end then reverse. The Review key sets the chase to Random.

9.2.6 JUMPING TO A STEP

You can jump directly to a step in a chase by pressing <Connect>, then typing in the desired step number, then pressing <Enter> or softkey A. Alternatively at the top level menu you can type the step number then press <Connect>.

9.3 EDITING A CHASE

9.3.1 OPENING A CHASE FOR EDITING

You can open a chase for editing by pressing <Record> then the Swop button of an existing chase. This does not affect any existing cues in the chase. You can then save new cues at the end by pressing the Swop button just like normal recording.

To see a list of the cues in the chase, use Playback view (touch the playback display above the fader or press <Open/View> then the Swop button of the playback). To edit any of the time settings in each cue, select the setting to be modified by touching or dragging in the grid, then use the softkey options to change the setting.

Playback View - Chase 'PRESS GO'							
	Legend	Delay In	Fade In	Fade Out	Fixture Overlap	Link	View Cue
1	Cue 1	Global	Global	= As In	Global	After Previous	View
2	Cue 2	Global	Global	= As In	Global	After Previous	View
3	Cue 3	Global	Global	= As In	Global	After Previous	View
5	Cue 5	Global	Global	= As In	Global	After Previous	View
6	Cue 6	Global	Global	= As In	Global	After Previous	View
7	Cue 7	Global	Global	= As In	Global	After Previous	View
8	Cue 8	Global	Global	= As In	Global	After Previous	View

9.3.2 EDITING A CHASE USING UNFOLD

Unfold provides another way to edit chases. The <Unfold> button places each cue in a chase on one of the playback faders, allowing you to fire and edit each cue individually as if it was a stand-alone cue. Unfold also allows you to set individual timing for cues in the chase.

- 1> Press the <Unfold> button, then the Swop button of the chase to be edited.
 - 2> The first 10 cues of the chase are loaded into the playback faders.
 - 3> Raise a playback fader to output the contents of that cue (fade times will operate as programmed).
 - 4> Various Unfold options are available, the details are below.
 - 5> Press <Unfold> again to get out of unfold mode.
- To edit the contents of a cue: Press Clear to empty the programmer, raise the fader to output the cue, make the changes, press [Record Step], then the Swop button for the cue number.
 - To insert a new cue at the end of the chase, set up the look for the new cue, press [Insert Step], then press the swop button of the first free playback.
 - To merge the programmer into the live step, double tap [Record Step].
 - To Insert a cue between two other cues, set up the look for the new cue, press [Insert Step], then type the cue number for the new cue (such as 1.5 to go between 1 and 2). If this cue number already exists it will be merged with the look you have created. Otherwise a new cue is inserted.
 - To change individual times for the cue, press [Edit Times], then the Swop button for the cue (or type the cue number), then set the times. This is described in detail in the Timing section on the following page.
 - If the chase has more steps than there are playback faders, you can go between pages using the [Previous Page] and [Next Page] buttons.

9.3.3 EXTRACTING A STEP FROM A CHASE WITH INCLUDE

You can reload a single cue/step from a chase into the programmer using Include. Press Include, select the chase, then enter the step number to be included, then press [Include Cue].

This is useful if you want to reuse a state from a chase in another chase or as a standalone cue. It is also useful if you want to edit shapes/effects in a step, although you can also do this from the Playback View window.

9.4 COPYING, MOVING, LINKING AND DELETING

9.4.1 COPYING OR MOVING A CHASE

Chases can be copied or moved to a new playback, or you can create a linked copy of a playback. Move is useful for tidying up the console. Linked chases are handy if you want a chase to appear on more than one page for ease of operation; the linked chase can have different timings and playback options.

This operation is exactly the same as for Cues and is described in detail in section 8.5.1 on page 213.

9.4.2 DELETING A CHASE

You can delete an entire chase by pressing <Delete> followed by the Swop button of the chase to delete. Press once more to confirm.

9.4.3 DELETING A STEP FROM A CHASE

To delete a single step from a chase:

- 1> Press <Delete> button.
 - 2> Press the Swop button of the chase.
 - 3> The steps in the chase are listed on the screen. Use the left hand wheel to select the step you want to delete, or type in the number of the step to be deleted.
 - 4> Press [Delete Cue x] to delete the step.
 - 5> Press [Confirm] to confirm the delete.
- Alternatively you can use the Unfold function to delete a step from a chase.

9.5 CHASE TIMING

9.5.1 GLOBAL TIMINGS FOR CHASES

When a chase is first programmed, each cue in the chase has identical timing. This is called the global timing for the chase. If you want you can then set each cue to have its own timings using the Playback View window or Unfold. This is described in the next section.

- 1> Press [Edit Times] from the top level menu then the Swop button of the chase.
 - 2> Set the Crossfade, Speed, Fixture Overlap and Attribute Overlap settings as described below.
 - 3> Press <Exit> to finish.
- To set speed, press [Speed] then type the new speed, then press <Enter>. The speed can be set in Beats Per Minute (BPM) or seconds depending on the user settings.
 - To set crossfade, press [Xfade] then type the fade from 0 – 100 and press <Enter>. 0=no fade (the chase will “snap”), 100=max fade (the chase will move continuously from cue to cue).
 - You can assign the blue or grey handle button to be a “tap tempo” button using the Key Profiles option (see section 16.3.1 on page 322).

The Overlap functions allow you to offset and overlap the timing of changes in the chase. This can create really amazing visual effects with hardly any programming. The best way to learn about overlap is to program a chase with two cues involving several fixtures, then experiment with the overlap settings to see the various “roll” and “peel off” effects which result.

The following diagram shows you the effects of cue overlap, fixture overlap and attribute overlap in chases.

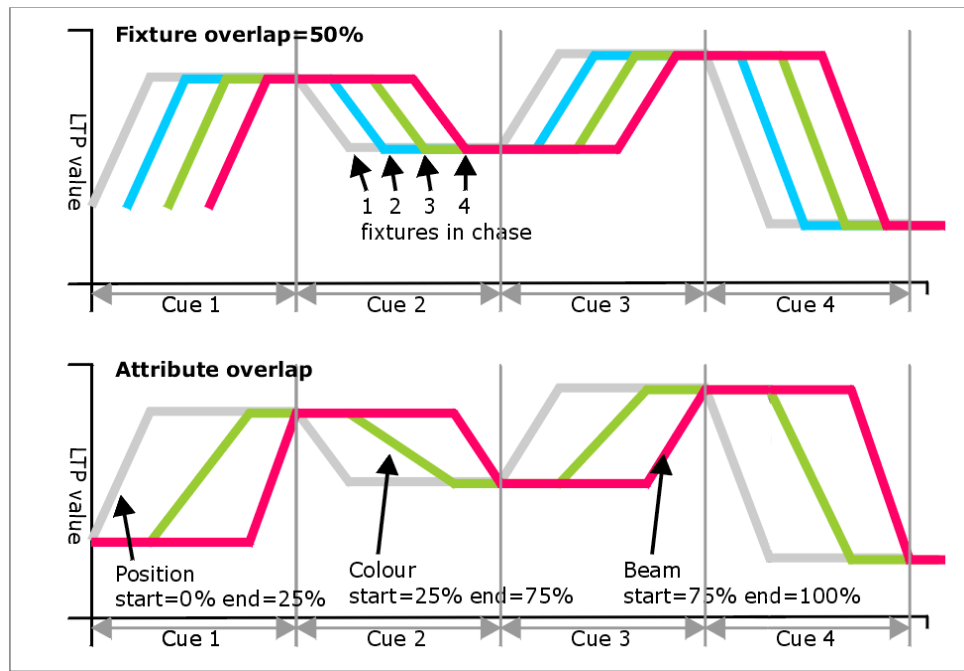

- Press [Fixture Overlap] then enter 0-100 on the keypad to change how fixtures overlap in the cue. 100% (the normal setting) means all fixtures fade together. 0% means that the first fixture will finish its fade before the next one starts giving a “rolling” change across a range of fixtures. 50% means that the 2nd fixture will start fading when the first one is half way through its fade. The order of the fixtures is set by the order you selected them when the cue was saved; you can change the order using Unfold.



From version 3 of Titan software, [Cue Overlap] is no longer available in chases. Instead use a Cue List set to “Link With Previous” and set the Offset as desired.

9.5.2 INDIVIDUAL CUE TIMES IN CHASES

You can configure each cue in a chase to have its own timing information. You can use the Playback View window, or the Unfold function to set individual times for cues in chases.



It is easier to use a Cue List rather than a chase if you need a lot of different timings or link/unlinks. Cue lists are described in the next chapter.

Using the Playback View window:

- 1> Touch the playback display relating to the fader, or press <Open/View> then the swop button of the playback. The Playback View window will open.

Playback View - Chase 'PRESS GO'							
	Legend	Delay In	Fade In	Fade Out	Fixture Overlap	Link	View Cue
1	Cue 1	Global	Global	= As In	Global	After Previous	View
2	Cue 2	Global	Global	= As In	Global	After Previous	View
3	Cue 3	Global	Global	= As In	Global	After Previous	View
5	Cue 5	Global	Global	= As In	Global	After Previous	View
6	Cue 6	Global	Global	= As In	Global	After Previous	View
7	Cue 7	Global	Global	= As In	Global	After Previous	View
8	Cue 8	Global	Global	= As In	Global	After Previous	View

- 2> In the grid, touch the times you want to edit.
- 3> Use the softkey options to change the times or settings.
- 4> Repeat from 2 to change other times or settings.

- You can change a range of cues all at once by dragging across the grid to select multiple cells, or you can use wheel B to select multiple cells for editing.

Using Unfold:

- 1> Press <Unfold> then the Swop button of the chase to be edited.
- 2> Press [Edit Times] then the Swop button of the unfolded cue you want to edit.
- 3> Set up the timing options as required. The options are described below.
- 4> Press <Unfold> to get out of unfold mode.

Initially all the timing options are set to Global. You can cancel any individual timings and set the time back to global timings by pressing the softkey for the option then pressing [Use Global].

The timing options for the cue are:

- Delay
- Fade (in)
- Fade Out
- Fixture Overlap
- Link with previous step
- Attribute times (see next section)

Linking can be set to [Link After Previous] (the chase will run automatically) or [Link Wait For Go] which will stop the chase until you press Go.

9.5.3 SETTING ATTRIBUTE FADE TIMES FOR A CUE IN A CHASE

For each cue in a chase, you can set individual fade times for each attribute group (such as position). If you set a time, it overrides the normal times. You can use the Cue View window, or the Unfold function to set attribute times.

To set an attribute group fade time:

- 1> Press <Open/View> or <Unfold>, then the Swop button of the chase to be edited.

- 2> Press [Edit Times] then touch the cue you want to edit in the Playback View, or if using *Unfold*, press the *Swap* button of the unfolded cue you want to edit.
- 3> Press the *Attribute Options* button (right hand side) for the attribute you want to change.
- 4> Press [Delay] to set delay time or [Set fade] to set fade time.
- 5> Type the new time using the numeric keypad and press <Enter> to save it, or press [Use Global] to delete the attribute times and go back to the normal times.
- 6> Press <Enter> to save the changes.

9.5.4 RATE AND BPM MASTERS

Chases can be allocated to Rate or BPM masters, allowing you to control the speed from a separate master fader. You set this by pressing [Effects] then [Speed Source] in the Playback Options for the chase. See section 13.1.4 on page 284.

9.5.5 SPEED MULTIPLIERS

Speed multipliers allow you to modify the chase speed, either faster (for example “x4”) or slower (for example “/4”). This is useful when running multiple chases together.

Press [Speed Multiplier] In the Edit Times menu for the chase, or use the [Speed Multiplier] option in the Playback category of the Playback Options for the chase. Use the [Multiply or Divide] softkey to swap the value between multiply and divide.

9.6 CHASE OPTIONS

To set options for a chase, press [Playback Options] on the root menu, then press the *Select* button of the playback to be edited. Options will be shown on the softkeys. To view the options window, press <View/Open> then the *Select* button of the playback, then click the *Options* tab.

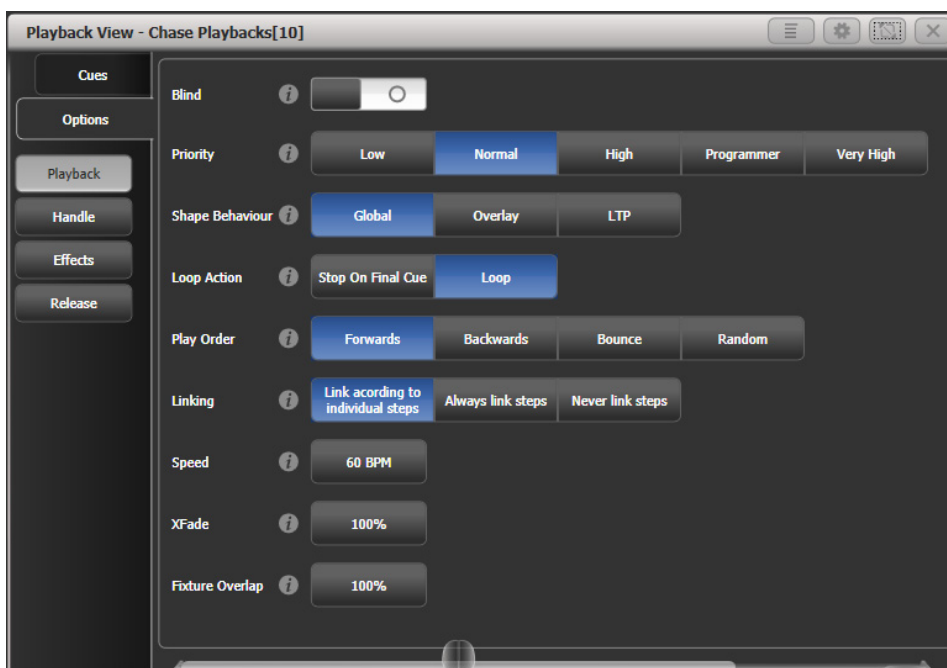

Most of the options are the same as for Cues (see section 8.7 on page 219), only the additional Chase options are described here.

9.6.1 CHASE OPTIONS – PLAYBACK TAB

Blind, Priority, Shape Behaviour are described in the Cues chapter.

Loop Action: Sets what happens at the end of the chase.

[Stop on Final Cue] – chase stops at the end

[Loop] - the chase will loop back to the beginning

Play Order: sets the direction of the chase.

Linking: Sets how the cues in the chase are linked. The options are:

[Link according to individual steps] - Each step in the chase will obey its individual link settings which are set using the Playback View window or the <Unfold> function.

[Always Link Steps] - The chase will run on its own using the times

[Never Link Steps] - The chase will pause after every delay/fade time for the user to press Go.



When a chase is unlinked, raising the fader does not fire the first cue, which can be a problem. To get round this, if the chase is not looped, simply link the first cue to the previous one. If the chase is looped, add a dummy step at the end with 0 sec fade, 0 sec delay and link the first step to this one.

Speed Multiplier: Allows you to set a speed factor for the chase. See section 9.5.4 on page 234 .

Speed: Provides another way of setting chase speed.

XFade: Provides another way of setting chase crossfade.

Fixture Overlap: Allows you to set the fixture overlap for the chase.

9.6.2 CHASE OPTIONS – HANDLE TAB

All options in this section are described in the cues chapter.

9.6.3 CHASE OPTIONS – EFFECTS TAB

All options in this section are described in the cues chapter.

9.6.4 CHASE OPTIONS – RELEASE TAB

Release Mask and Release Time are described in the cues chapter.

Cue Release: allows you to create an overlay chase with gaps in it where the fixtures will return to their previous state. For example you could create a chase where every alternate cue sets the fixtures to white, with the in between cues being blank. If this option is on, the fixtures will bump to white then return to the colour set from a previous look.

9.6.5 RENUMBER ALL CUES

This option is only available on the softkeys, not the option screen. This will renumber all the cues in the chase starting from 1.

10. CUE LISTS

Cue Lists (sometimes known as stacks or cue stacks) allow you to record a sequence of cues, each of which can have its own timings and can be triggered by the Go button or run automatically to the next cue. This allows you to build a complete show in a single list and is ideal for theatrical shows where the show must be exactly the same each time. Cue lists can also be useful in busked shows, especially on consoles with a small number of playback faders, to offer a number of different looks on one fader.

Cue lists differ from chases in the way the console handles changes between cues. Cue lists track fixture state from previous cues and will only change the fixture state if you have modified that fixture in the cue; if there are no changes stored for the fixture, it will remain in the same state. Chases on the other hand would crossfade between cues, fading out all fixtures which have no stored information in the new cue.

You can change the tracking behaviour of cue lists using the tracking option for each cue: Block, This Cue Only and Solo (see section Tracking on page 243).

To view the contents of a cue list, touch the playback screen relating to the fader or press <Open/View> then the swop button of the playback.

Playback View - Cue List Playbacks[7]												
	Legend	Delay In	Fade In	Delay Out	Fade Out	Fixture Overlap	Link	Link Offset	Preload	Curve	Autoload	Time
1	Tabwarm	0	2	= As In	= As In	100%	Wait For Go	Disabled	<input type="checkbox"/>	Linear	Load Cue RollerB[3];	23:5
2	Cue 1	0	2	= As In	= As In	100%	Wait For Go	Disabled	<input type="checkbox"/>	Linear		23:5
3	End of scene	0	2	= As In	= As In	100%	Wait For Go	Disabled	<input type="checkbox"/>	Linear		23:5
4	Cue 2	0	2	= As In	= As In	100%	Wait For Go	Disabled	<input type="checkbox"/>	Linear		23:5
5	Cue 5	0	2	= As In	= As In	100%	Wait For Go	Disabled	<input type="checkbox"/>	Linear		23:5
6	Cue 6	0	2	= As In	= As In	100%	Wait For Go	Disabled	<input type="checkbox"/>	Linear		23:5

10.1 CREATING A CUE LIST

10.1.1 PROGRAMMING A CUE LIST

Programming a cue list is similar to recording a chase.

You need to set up the look on the stage for each cue and then add it to the cue list. If you want to set fade times, you can either set them while saving the cues or later.

- 1> Press <Record> then [Create Cue List].
- 2> Press the select button of the playback where you want to store the Cue List (you can also store cue lists in the Playbacks window).
- 3> Select the Record Mode of the console: by Fixture, Channel, Stage or Quick Build; if you are using tracking, [Record Mode Channel] is best as you are sure to only record the attributes you have explicitly set, but you do need to make sure you have changed all the things you want to be recorded so they are in the programmer.

- 4> Set the default Fade and Delay times, and automatic cue linking, using [Set Times]. These settings will be allocated to every new cue.
 - 5> Set up the look for the first cue, either manually or by using <Include> on existing cues. You can use the Shape Generator and the Pixel Mapper.
 - 6> If you require a legend for the cue, set it now using [Legend]. You can also change this later using <Unfold> or Set Legend (see next section).
 - 7> Press the Select button of the handle or [Append Cue] to store the programmer contents as Cue 1 of the cue list.
 - 8> Repeat from step 5 for the next cue. Do not press <Clear> in between cues, unless you want levels to track through from previous cues, as any faders moving to zero will not be stored. If you do press clear, you must make sure that all channels you want to record are selected or in the programmer (inverted display).
 - 9> Press <Exit> to finish when you have stored all the cues you want.
- [Record Mode] lets you select Record By Fixture (all attributes of any modified or selected fixture are saved), Record By Channel (only modified attributes are saved), Record Stage (all fixtures with a non-zero dimmer channel are saved) or Quick Build (allows you to build a cue from other playbacks or palettes; select the playbacks/palettes you wish to use and press [OK]).
 - Record By Channel is useful if you want to layer this cue list with other playbacks to create an effect.
 - You can reopen the cue list to add more cues by repeating the procedure above; this does not affect any cues already stored in the cue list.
 - To add more cues to the end of the existing cues press [Append cue].
 - To edit an existing cue, press [Cue Number=] and type the cue number to edit. Make the changes then press [Update Cue x].
 - To insert new cues, see section 10.3.5.
 - The Advanced Options menu allows you to renumber all the cues, and to change the number of an existing cue.
 - There is no limit to the number of cues in a cue list.
 - Cue lists offer a Move In Dark function which will move fixtures to the correct position for their next cue while they are set to zero intensity. See section Move In Dark (MID) functions on page 244.
 - You can change the tracking mode of each cue. See section 10.2.3 on page 243.

10.1.2 CHANGING LEGENDS FOR CUES IN A CUE LIST

You can set a legend for each cue, which is shown on the screen when running the cue list and can be helpful for keeping track of where you are.

- 1> Press [Set Legend] in the top level menu. If you are setting legends for several cues, press <Menu Latch> to latch the Set Legend menu.

- 2> Press the Select button of the Cue List.
- 3> The cues in the cue list are shown on the screen. Touch the list or use Wheel A to select the cue which is to have a legend set.
- 5> Press [Cue Legend] and type the legend on the keyboard, then press <Enter>.
- 6> If you latched the menu, you can continue to set legends for other cues, or press <Exit> to finish.

10.1.3 SHAPE TRACKING IN CUE LISTS

Shapes can track between cues in cue lists. If shape tracking is enabled, a shape started in a cue will continue through following cues. Shape tracking is enabled using the [Shape Tracking] option in the Playback Options for the cue list – see section 10.6.4.

Cues containing shapes have a button for each shape.

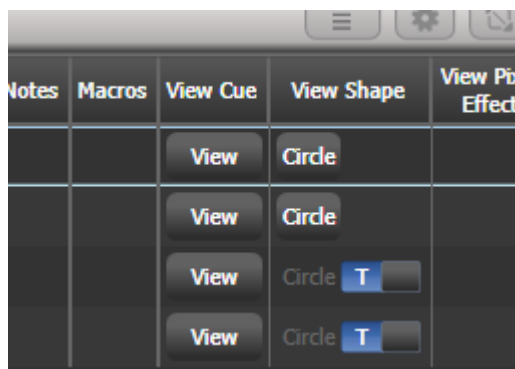

In the following cues where shapes are tracking, an option switch is shown for each active shape.

T – Allows the shape to track to the next cue

B – Blocks the shape so it will not appear in following cues

The cue itself can also have options set to block all shapes, see section 10.6.7.

You can also block attributes for shapes independently during recording using the @ menu. Select the Attribute using the attribute bank buttons, press @ then the FX group button. The softkeys will then give the options [Block Shape] and [Unblock Shape]. If an attribute is set to Blocked the wheel display will show a “Blocked” watermark.

If Shape Tracking is not enabled, shapes in each cue are independent from each other. If an identical shape (with the same size and speed) is saved in a following cue then the shape will continue running rather than restarting.

10.1.4 AUTOLOADING A PLAYBACK WITHIN A CUE LIST

You can program a cue within a cue list to automatically load one or more playbacks when the cue fires. The playback can be a single cue, a chase or another cue list. This can be a useful way to trigger chases or effects from the cue list.

You can either automatically save active playbacks as Autoloads, or you can manually allocate Autoloads to cues.

To automatically record active playbacks as Autoloads:

- 1> After selecting Cue List Record, turn on [Autoload Live Playbacks] in the [Advanced Options] menu of the cuelist record screen.

- 2> Turn on the playbacks you wish to load for this cue.
- 3> Save the cue. Active playbacks will be saved as Autoloads.

To manually edit autoloads use the playback view for the cue list:

- 1> Press <View/Open>
- 2> Press the blue Select button of the Cue List.
- 3> The cues in the cue list are shown on the screen. Click on the Autoload you wish to change. (You will need to set the window to full screen size or scroll across to see the Autoload column. If the Autoload column is not show, click on the Show All button on the left of the window.)
- 4> Press the Select button of the playback which is to be loaded. The playback legend appears on the softkeys.
- 5> You can continue to add Autoloads to other cues, or press <Exit> to finish.

Playback View - Cue List Playbacks[7]												
	Legend	Delay In	Fade In	Delay Out	Fade Out	Fixture Overlap	Link	Link Offset	Preload	Curve	Autoload	Time
1	Tabwarm	0	2	= As In	= As In	100%	Wait For Go	Disabled	<input type="checkbox"/>	Linear	Load Cue RollerB[3];	23:5
2	Cue 1	0	2	= As In	= As In	100%	Wait For Go	Disabled	<input type="checkbox"/>	Linear		23:5
3	End of scene	0	2	= As In	= As In	100%	Wait For Go	Disabled	<input type="checkbox"/>	Linear		23:5
4	Cue 2	0	2	= As In	= As In	100%	Wait For Go	Disabled	<input type="checkbox"/>	Linear		23:5
5	Cue 5	0	2	= As In	= As In	100%	Wait For Go	Disabled	<input type="checkbox"/>	Linear		23:5
6	Cue 6	0	2	= As In	= As In	100%	Wait For Go	Disabled	<input type="checkbox"/>	Linear		23:5

The Autoloaded playback will be fired when the cue starts, and killed when the cue list moves on to the next cue, unless you have also loaded the playback into the next cue.

You can set options for each Autoloaded playback by pressing the softkey where the Autoloaded playback is shown.

For a cue, the only option is [Remove this Autoload].

For a chase or cue list, softkey B lets you select whether to load the playback from the start, to start at a specific cue, or to press Go on the target playback.

In the Autoload Times column you can set fade in, fade out and delay times for the autoloaded playback. Normally the autoload will use the times set for the cue, but you can also select [Use Individual Target Times] which will use the times set in the autoloaded playback, or you can set independent times yourself.

10.1.5 RUNNING A KEY MACRO FROM A CUE LIST

You can program a cue within a cue list to trigger a key macro. This allows you to set up custom actions which can be performed when a cue in a cue list fires; for example you may want to lamp on your fixtures as the first cue in the cue list.

- 1> Press [Playback Options].
- 2> Select the cue list.
- 3> Select [Macros].

- 4> In the Playback View window, select the step you want to add a macro to.
 - 5> Press the button(s) for the macro(s) you want to attach to the step. Or press [Add] and choose an action from the list.
 - 3> The "Macros" column shows the macros you have added.
- You can remove macros by selecting the cue, pressing the softkey for the macro you wish to remove and then pressing [Remove Link].

10.1.6 KEYBOARD SHORTCUTS/SYNTAX FOR CUE LISTS

The following keyboard syntax can be used for fast cue list recording and editing. These commands work for the selected or currently connected playback where n is the cue number.

- <Record>, <Connect>, n, <Enter> (Record cue n)
- <Copy>, <Connect>, n (Copy cue n)
- <Delete>, <Connect>, n (Delete cue n)
- <Include>, <Connect>, n (Include cue n)
- <Connect>, n, <Go>. (Go cue n)

10.2 CUE LIST PLAYBACK

10.2.1 RUNNING A CUE LIST

Raise the fader of the cue list and press the Go button to run the first cue. The bottom section of the display shows the cue list; the current cue is highlighted in grey and the next cue has a box round it.

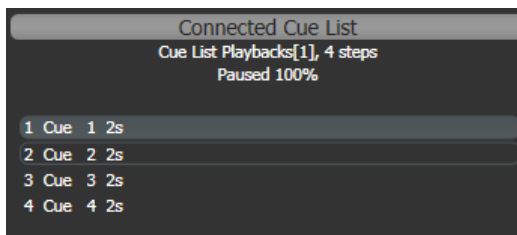

Also the display relating to the playback fader shows information about the cue list, including the current and next cue, fade progress of the current cue, and fade in/out times.

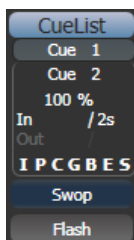

You can also open the Playback View window to show more details of the cue list by clicking the Cue List legend area or press <View/Open> then the swop button of the

playback. This shows all the timings, links and tracking status and is very useful when running a theatre show on a cuelist.

The option “Auto View On Connect” (in the User Settings/Wheels menu) if enabled will automatically open the relevant Playback View window when you fire a cue list.

Cues	Legend	Delay In	Fade In	Delay Out	Fade Out	Fixture Overlap	After
1	Cue 1	0	3	As In	As In	100	After
2	Cue 2	0	3	As In	As In	100	After
3	Cue 3	0	3	As In	As In	100	After
4	Cue 4	0	3	As In	As In	100	After

When times are in progress on a cue, green progress bars are shown in the Playback View window.

The Playback View will autoscroll to keep the active cue onscreen. You can change the way the autoscroll works using the view options (click the options/cog icon at the top of the window).

- The HTP levels of cues in the cue list are mastered by the fader level.
- You can pause a fade by pressing the <Stop> button above <Go>. Press <Go> again to resume the fade.
- You can skip to any cue in the cue list by selecting a “next” cue using Wheel A, or using the left/right arrow keys. When you press <Go>, the cue list will run that cue next.
- You can snap back to the previous cue by pressing the <Snap Back> button (not on all consoles)
- On consoles with a <Snap> button (Arena and Tiger Touch 2), when you turn on the <Snap> button the <Prev>/<Next> buttons will snap immediately to the cue rather than going to the previous/next cue using the programmed times. There is also a User Setting [Chase Snap] which enables this mode on consoles which don't have the button.
- You can jump directly to a cue by pressing <Connect>, then typing in the desired cue number, then pressing <Enter> or softkey A. Alternatively at the top level menu you can type the cue number then press <Connect>.
- You can use Key Profiles to set the blue and grey buttons of the playback to have various functions including Go, Stop, Connect, Next Cue, Prev Cue, Cut Next Cue To Live, and Snap Back, see section 10.2.5 below.

- When you lower the fader for a cue list, the HTP channels will fade out, but the cue list will remain active. The section below details how to kill the cue list.
- You can use timecode to play back a cue list automatically. See section 10.5.5 on page 254.
- You can change the time for the next cue by entering the time on the keypad then pressing <Go>. You can jump to another cue and set a different time by typing the cue number then press <Connect>, then type the time and press <Go>.

10.2.2 KILLING A CUE LIST

Once a cue list is fired, it remains active until you kill it. You do this by holding down the <Avo> button and pressing the blue Select button of the cue list's handle.

You can change this in the Playback Options to make the cue list automatically clear when the fader reaches zero (press [Playback Options] at the program menu, then press the Select button of the cue list, then select [Fader] [Fader Mode Intensity Kill At 0]).

You can also use Key Profiles to configure one of the handle buttons to release the cue list.



While the cue list remains active, any shapes/effects stored in the current cue will run even if the fader is at zero. If you are working with a cue list and have unexplained shapes occurring, check all cue lists have been killed.

10.2.3 TRACKING

By default, cue lists run in tracking mode. Only changes in attributes are stored, everything else just continues at the level it was previously set to. Tracking mode is usually used for theatrical performances because it makes editing much easier; if you need to adjust a dimmer level at the start of a scene, you don't have to go through and change the level on every cue for that scene, the change just tracks through the other cues until a new level is stored.

You can enable or disable Tracking mode globally for the whole cue list, or each cue can have Tracking mode set individually from the Playback View window (or Playback Options, [Cue Options]).

Settings are:

- [Global] (default): obeys the global setting for the cue list.
- [Track]: the cue will track
- [Block]: the cue will not take tracking states from previous cues. All subsequent cues will track from the Block cue.
- [Solo Excluding Shapes]: No states are tracked into or out of the cue, but shapes will track into the cue, except for dimmer shapes which will not track. This lets you have a cue that solos all levels but allows non-dimmer shapes to continue.
- [Cue Only]: changes in this cue will not track to subsequent cues. Unchanged states from previous cues will be restored in subsequent cues.

- [Solo]: No states are tracked into or out of a solo cue. States from previous cues will track to subsequent cues but will not appear in the solo cue.
- [Block Shapes]: Any tracked shapes will stop from this cue. Other attributes will continue to be tracked. This lets you create a point where you can guarantee all shapes will stop.

10.2.4 MOVE IN DARK (MID) FUNCTIONS

When using moving lights in theatre, often you would like them to be positioned ready for the next cue so that you do not see them moving. The Move In Dark function does this by automatically positioning the fixture for the next cue when it is not lit.

Move In Dark options can be set either for the whole cue list or for individual cues.

Options for the whole cue list are set by pressing [Playback Options] then the select button for the cue list, then [Playback].

- [Disabled] prevents Move In Dark functions for all cues in the cue list regardless of the individual cue settings.
- [Early] will attempt to position a fixture as soon as possible unless overridden in an individual cue.
- [Late] will position the fixture as late as possible.
- [Off] turns off Move In Dark unless enabled in individual cues (default).

For individual cues the options are set using the Playback Window.

- [Global] uses the cue list's global setting (default)
- [Cue Number] specifies a cue where you would like the move to occur
- [Cue Offset] specifies a preferred number of cues in advance
- [Disabled] prevents Move In Dark for this cue
- [Early] will move as early as possible
- [Late] will move as late as possible.

Move In Dark delay and Move In Dark fade times can be set for the whole cue list or for each cue using the Set Times menu. Each cue also has a Move In Dark Inhibit option which prevents any movements during that cue (useful if you need to prevent fixture noise at a particular point).

If the fixture has its intensity above zero or Move In Dark is inhibited when the Move In Dark is supposed to occur, the console will attempt the movement in the nearest suitable cue instead.

10.2.5 KEY PROFILE OPTIONS FOR CUE LISTS

Using Key Profiles, you can assign different functions to the blue and grey buttons of the playback handle. (The Sapphire Touch also has a black button). If the cue list is stored on a touch button you can assign a function to that. Settings are:

- Disabled – the button will do nothing

- Flash – all dimmer levels in the cue will flash to programmed level, when released the levels will return to previous level
- Flash and Go – as Flash, but when button released the cue list will advance to the next cue
- Timed Flash – as Flash, but fade in and out times will follow the cue times set
- Timed Flash and Go – as Flash and Go, but cue list will advance on release
- Swop – as Flash, but all other fixtures will black out
- Latch – as Flash, but dimmers will remain active until button pressed again
- Go – cue list will advance to next cue using times
- Stop – stops all fades in the cue list at their current point
- Preload – LTP channels of non-illuminated fixtures will move to positions in next cue
- Connect – connects this cue list to controls (same as pressing <Connect> then select button of cue list)
- Tap Tempo – set speed parameter by tapping the button
- Next Cue – - press repeatedly to select the next cue to be output., going back
- Next Cue + - press repeatedly to select next cue to output, going forwards
- Review Live Cue – replays the current cue using fade times
- Cut Next Cue to Live – output the cue as selected using above
- Snap Back – cue list will snap back to previous cue without times
- Go Back – cue list will go back to previous cue using fade times
- Release – release the playback using programmed release time
- Select If – press to select all fixtures used in the current cue

10.3 EDITING CUE LISTS

10.3.1 PLAYBACK VIEW WINDOW

The easiest way to edit a cue list is using the Playback View window (press <View/Open> then the select button for the cue list to open it). This shows a grid with each cue and allows you to change most features of the cue. Click on the item you want to change in the grid, and the softkeys will offer you the different options.

To change multiple cues at once, draw a box across the items you want to change.

The Intensity View window is useful for seeing the state of all fixtures, see section 5.2.2 on page 132.

10.3.2 EDITING VALUES IN CUE VIEW WINDOW

You can edit the value of every fixture in each cue using the Cue View window. Press the View Cue button at the right hand end of the Playback View window.

Cue View - Cue 1																	
	Number	Order	Dimmer	Shutter	Pan	Tilt	Colour Func	Colour Macros	Colour	CTO	White	Cyan	Red	Magenta	Green	Yellow	Blue
Robin600ES	101	1	100.00	Open	58.49	55.22	Fixed		Open	0.0		0.0		0.0			0.0
Robin600ES	102	2	100.00	Open	36.51	59.01	Fixed		Open	0.0		100.0		89.0			0.0
Robin600ES	103	3	100.00	Open	63.67	59.08	Fixed		Open	0.0		0.0		0.0			0.0
Robin600ES	104	4	100.00	Open	44.33	56.06	Fixed		Open	0.0		100.0		89.0			0.0
Robin600ES	105	5	100.00	Open	66.90	34.02	Fixed		Open	0.0		100.0		89.0			0.0
Robin600ES	106	6	100.00	Open	67.14	37.55	Fixed		Open	0.0		0.0		0.0			0.0
Robin600ES	107	7	100.00	Open	67.10	64.37	Fixed		Open	0.0		100.0		89.0			0.0
Robin600ES	108	8	100.00	Open	32.42	34.05	Fixed		Open	0.0		0.0		0.0			0.0
Robin600ES	109	9	100.00	Open	65.26	35.27	Fixed		Open	0.0		0.0		0.0			0.0
Robin600ES	110	10	100.00	Open	39.41	42.83	Fixed		Open	0.0		100.0		89.0			0.0
Robin600ES	111	11	100.00	Open	60.06	42.83	Fixed		Open	0.0		0.0		0.0			0.0
Robin600ES	112	12	100.00	Open	35.03	37.34	Fixed		Open	0.0		100.0		89.0			0.0
Robin600ES	113	13	100.00	Open	55.59	36.55	Fixed		Open	0.0		100.0		89.0			0.0
Robin600ES	114	14	100.00	Open	41.78	36.55	Fixed		Open	0.0		0.0		0.0			0.0

You can then click on the values you want to change and edit them using the softkeys.

- The context menu buttons allow you to view levels, shapes, effects and times for each attribute of each fixture in each cue.
- If levels are set from a palette, the View Palettes button either shows you the palette used, or the underlying value.
- If the View Tracking Values button is selected, tracking values (values which have tracked through from another cue rather than being stored directly in this cue) are shown in light grey.

10.3.3 MOVING AND COPYING CUES

You can copy or move cues within a cue list or to other cue lists. Either click and drag the cue in the Playback View window (press Open/View then the select button for the cue list), or use Unfold (next section), or you can use a command-line style series of keypresses.

Copy/Move within the same playback:

- COPY/MOVE <playback> <cue> [THRO <cue>] [NOT <cue>] [AND <cue>] @ <cue> ENTER
- COPY/MOVE <playback> <cue> [THRO <cue>] [NOT <cue>] [AND <cue>] ENTER <cue> ENTER

Copy/Move to the end of the same playback:

- COPY/MOVE <playback> <cue> [THRO <cue>] [NOT <cue>] [AND <cue>] @ @
- COPY/MOVE <playback> <cue> [THRO <cue>] [NOT <cue>] [AND <cue>] ENTER ENTER

Copy/Move to a different playback:

- COPY/MOVE <playback> <cue> [THRO <cue>] [NOT <cue>] [AND <cue>] [@][ENTER] <playback> <cue> ENTER

Copy/Move to the end of a different playback:

- COPY/MOVE <playback> <cue> [THRO <cue>] [NOT <cue>] [AND <cue>] [][ENTER] <playback> ENTER
- COPY/MOVE <playback> <cue> [THRO <cue>] [NOT <cue>] [AND <cue>] [][ENTER] <playback> <playback>

(<playback> is a playback swop key, <cue> is the cue number and sections in square brackets are optional)

10.3.4 EDITING A CUE LIST USING UNFOLD

The <Unfold> button places each cue of the cue list on one of the playback faders. This allows you to fire and edit each step individually as if it was a stand-alone cue.

- 1> Press <Unfold>, then the Select button of the cue list to be edited.
- 2> Cues are loaded into the playback faders. The display shows the cue numbers and legends (see more cues using softkeys F and G).
- 3> Raise a playback fader to output the contents of that cue (fade times will operate as programmed).
- 4> Various Unfold options are available, the details are below.
- 5> Press <Unfold> again to get out of unfold mode.

- To edit the contents of a cue: Press <Clear> to empty the programmer, raise the fader to output the cue, make the changes, press [Record Step], then the Select button for the cue number.
- To merge the programmer into the live step, double tap [Record Step].
- To change the times or cue linking for the cue, press [Edit Times], then the Select button for the cue, then set the times (see Timing on the following page)
- To insert a new cue, set up the look for the new cue, press B [Insert Step], then press the playback button where you want the new cue to go. All following cues will be shifted on by one and the new cue will be given a number in between the two existing cues (for example, if you press playback 3, your new cue will be 2.5).
- To move or copy a cue, press the <Move> or <Copy> button, press the select button for the cue you want to move or copy, then press the select button where you want it to go.
- To delete a cue, press the <Delete> button then the select button for the cue you want to delete. Press the select button again to confirm.
- To change the cue legend, press [Set Step Legend] then the playback select for the step you want to change.
- If the cue list has more cues than there are playback faders, you can swop to the next page using softkeys F and G.

10.3.5 USING UPDATE TO CHANGE TRACKED CUES

Because fixture settings in a cue list are tracked through from previous cues, if you want to edit a setting you need to find the cue where it was originally set.

The Update function will go back through the cue list from the currently fired cue and automatically update the correct cue.

- 1> With the cue list fired, select the fixtures and change them to the settings you want to store.
 - 2> Press <Update> (<Record Cue>, [Update] if the console doesn't have an Update button).
 - 3> Press <Enter> to immediately store the new values to the cue list.
Alternatively, the softkeys show a list of palettes and playbacks which can be updated. Select or deselect these as required.
 - 4> If you have used the softkey options, press <Enter> to complete the update.
- If the attributes you have changed were tracked through from a previous cue, Update will update that cue rather than the current one.

10.3.6 EDITING A CUE LIST WHICH IS RUNNING

You can also edit cues in a cue list while you are running it without using Unfold.

- 1> Fire the cue list by raising its fader.
 - 2> Use Wheel A to select the cue number you want to change then the <Go> button to jump to it. (On Pearl Expert/TT Mk1 press the white ↔ button above the Snap Back button instead of <Go>)
 - 3> Press <Clear> to make sure the programmer is empty.
 - 4> Make the changes that you want to the current step.
 - 5> Press <Record> then <Connect>, then select [Replace], [Merge] or [Insert After] to save the changes. (On Pearl Expert and TT Mk1 use the Rec Step button)
 - 6> Press the <Go> button (on Pearl Expert and TT Mk1 the white ↔ button) to jump on to the next step.
- You can edit the times for a cue using the <Live Time> and <Next Time> buttons (not on all consoles) as follows:
 - 1> Fire the cue list by raising its fader.
 - 2> Use Wheel A to select the cue number you want to change then the <Go> button to jump to it (on Pearl Expert and TT Mk1 the white ↔ button)
 - 3> Press <Live Time> to set the times for the current step, or <Next Time> for the next step. The Live and Next step numbers are shown on the display above the controller wheel.
 - 4> Use the softkeys to set the times, linking and overlap settings you want (see section 8.6.1 on page 214 for description of the times). If you set the [Link to next step] option to On, then the next cue will not wait for the <Go> button.
 - 5> Press the <Go> button (on Pearl Expert and TT Mk1 the white ↔ button) to jump on to the next step.
 - The Review button lets you test the live step with the new timings.
 - You can also use <Unfold> to set the times as described in the Unfold section above.

10.3.7 EDITING A CUE LIST WHILE RECORDING

You can edit cues while you are in the Record Cue List menu.

- 1> Press [Cue Number=x] and type the cue number to be edited.
- 2> The console will jump to the cue and show the output.
- 3> Make the changes that you want to the programming of the current step, or to the timings using [Edit Cue x Times].
- 4> Press [Update Cue x] or the Rec Step button to save the changes.

- The [Update Mode] softkey allows you to set how changes in the cue will be tracked. [Update Mode Forwards] updates the channels in the current cue and tracks following cues until the channels are next changed. The values in cues before this one will not be changed. [Update Mode Backwards] updates the current cue and tracks backwards through cues until the channels were last changed. [Update Mode Both] will update the current cue, tracking backwards through previous cues from the previous change and forwards through following cues to the next change. [Update Cue Only] will just set the current cue.

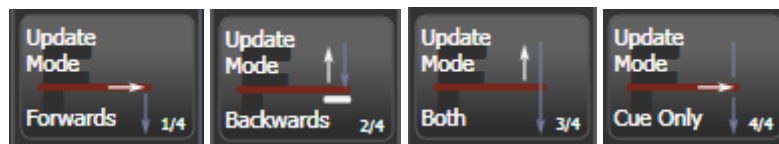

- You can't change the cue number using this menu – if you press [Cue Number] this will change the cue you are editing. Use [Advanced Options] to change cue numbers.

10.3.8 UPDATING VALUES IN A RANGE OF CUES

You can merge or replace values in a range of cues in a cuelist (or a chase). This can be done either from the keypad or from the Playback View.

From Playback View, press <Record> then select a cue or range of cues by touching and dragging over the required cues. Select [Merge] or [Replace] (or press <Enter> to merge). The current programmer will be merged into all of the selected cues.

From the keypad, connect the cue list (or chase) and press <Rec Step>. Then use the syntax <n> THRU <m> to select a range or <n> AND <m> to select cues which aren't together. The selected cues will highlight in red in the Playback View if you have it open. When you have selected all desired cues press <Enter>, then select [Merge] or [Replace] (or just press <Enter> again to merge).

10.3.9 DISABLING A CUE

You can temporarily disable a cue using the Disable option at the right hand end of the Playback View window. Select the Disabled box and the softkeys let you set [Cue Disabled]. When a cue is set to Disabled it will be skipped. This can be a useful way to remove a cue, but still be able to put it back in later.

10.3.10 EXTRACTING A CUE FROM A CUE LIST WITH INCLUDE

You can reload a single cue out of a cue list into the programmer using Include. Press <Include>, select the cue list, enter the cue number to be included, then press [Include Cue].

If you want to do this from the currently connected cue list, Press <Include>, <Connect>, type cue number, [Include Cue].

This is useful if you want to reuse a state from a cue list in another playback. It is also useful if you want to edit shapes/effects in a cue, although you can also do this from the Playback View window.

10.4 COPYING, MOVING, LINKING AND DELETING

The previous section also has other methods of copying and moving individual cues within a cue list.

10.4.1 COPYING OR MOVING A CUE LIST

Cue lists can be copied or moved to a new playback, or you can create a linked copy of a playback. Move is useful for tidying up the console.

This operation is exactly the same as for Cues and is described in detail in section 8.5.1 on page 213.

10.4.2 DELETING A CUE LIST

You can delete a whole cue list by pressing <Delete> then the Select button of the playback to be deleted. Confirm the deletion by pressing the select button again, the [Confirm] softkey, or <Enter>.

10.4.3 MOVING A CUE IN A CUE LIST

You can move an individual cue in a cue list by selecting it in the playback view window and changing the number using the [Change to] softkey. It will then move to the right place in the list, for example to go between cues 14 and 15 set the number to 14.5.

See section 10.3.3 on page 246 for more ways to move and copy cues, including ways to copy cues between different cue lists.

10.4.4 DELETING A CUE FROM A CUE LIST

To delete a single cue from a cue list:

- 1> Press the <Delete> button.
- 2> Press the Swop button of the cue list.
- 3> The cues in the cue list are listed on the screen. Use the left hand wheel to select the cue you want to delete, or type in the number of the cue to be deleted.
- 4> Press [Delete Cue x] to delete the cue.
- 5> Press [Confirm] to confirm the delete.

- Alternatively you can use the <Unfold> function to delete a cue from a cue list.

10.5 CUE LIST TIMING

10.5.1 TIME AND FADE OPTIONS FOR CUE LISTS

Time settings are independent for each cue in the cue list. The display shows which cue you are working with. You can select which cue is active using Wheel A or softkey A of the Cue Times menu.

See the diagrams in section 8.6.1 on page 214 and section 9.5.2 on page 232 for more information about overlaps and fade times.

- 1> *Press A [Edit Times] at the main Program menu then the Swop button of the Cue List.*
 - 2> *To change which cue you are editing, scroll through the list using Wheel A or press [Cue Number] then type the cue number you want to edit and press <Enter>. The Chase arrow buttons to the right of the Connect button also step through the cues.*
- You can select a range of cues, enabling you to alter the timings of multiple cues all in one go, by using Wheel B, or in the Playback View window, dragging across the cues you want to select in the grid.
 - To set the delay time between pressing <Go> and the cue starting, press [Delay In] then type a time in seconds and press <Enter>.
 - To set the fade in time of the cue, press [Fade In] then type a time in seconds and press <Enter>. Both HTP and LTP channels are affected by the fade.
 - The fade out time of the cue is set by default to be the same as the fade in time. You can change the fade out time by pressing [Fade Out], then type the time in seconds and press <Enter>. To set equal to Fade In time, delete the time and leave the box blank.
The fade out time starts when the next cue fires, so if you set the time to 1 second, the outgoing cue would start a 1 second fade out as the new cue begins its fade in.
 - The [Delay Out] setting of the cue would normally be used if the console links automatically to the next cue, and sets a wait time before the next cue starts its fade in. So the outgoing cue would start to fade out, and the delay out time would run before the new cue begins its fade in.

10.5.2 CUE LINKING & LINK OFFSET

Cues in cue lists may be linked together, allowing you to build up complex self-timed sequences. The link options are set using the softkeys and are:

- [Link Wait For Go]: the cue waits for the Go button to be pressed then fires immediately. Link Offset is disabled.
- [Link After Previous Cue]: The cue fires when the previous cue has finished its delay in and fade in times. A Link Offset can be set to add a delay between the previous cue finishing and this cue firing. The offset can be given as a time in seconds, or as a percentage of the fade time of the previous cue.
- [Link With Previous Cue]: The cue fires at the same time as the previous cue fires. A Link Offset can be set to add a delay between the previous cue firing and

this cue firing, set either in seconds or as a percentage of the fade time of the previous cue.

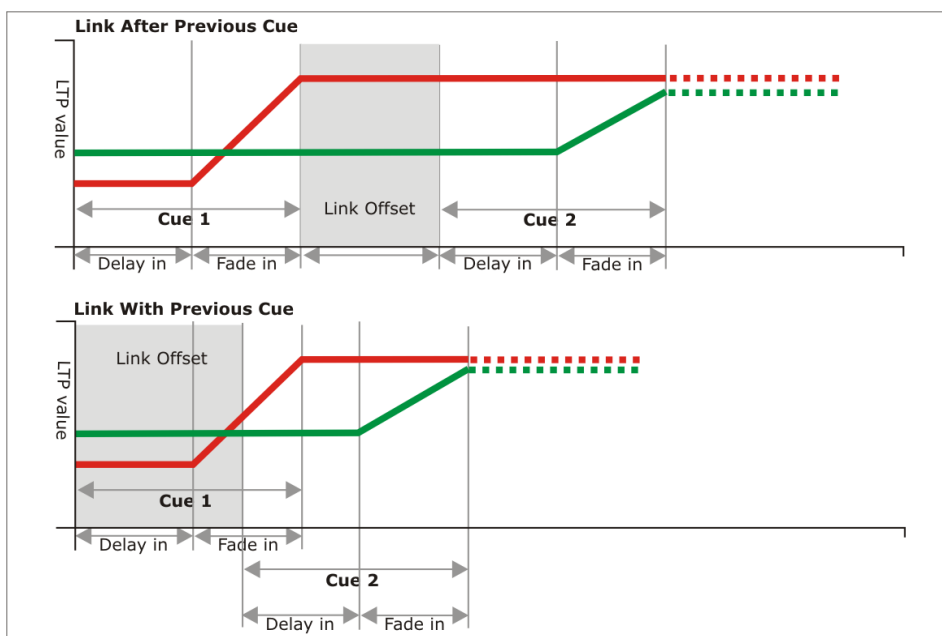

These options allow you to create complex self timed sequences by building up simple steps. For example if you wanted the following effect:

- <Go> is pressed, fixture one starts fading up over 20s
- After 10s fixture two fades up over 15s
- Both lights stay on for 5s
- Both lights go off in 3s

You could program

- Cue 1 - Fixture 1 @ 100%, Fade In 20s, Link Wait For Go
- Cue 2 - Fixture 2 @ 100%, Fade In 15s, Link With Previous, Link Offset 10s
- Cue 3 - Fixture 1 AND 2 @ 0%, Fade Out 3s, Link After Previous, Link Offset 5s



To obtain the effect which was called “cue overlap” in previous versions of software, use [Link With Previous Cue] and set a percentage Link Offset time. Link Offset of 100% is equivalent to Cue Overlap of 0% and vice versa.

10.5.3 INDIVIDUAL ATTRIBUTE FADE TIMES

You can set individual fade times for each IPCGBES attribute group. You can also select which fixtures this is applied to. For example you can make the position change take 2 seconds, but the colour change take 10 seconds.

Additionally you can set individual times for each attribute so you could make the pan fade over a different time to the tilt.

To set times for an attribute group, first select the Set Times menu and go to the cue you want to set as described above, then press G [Next] to go to the second page of options.

- 1> Press C [Attribute times].
 - 2> All fixtures in the cue will be selected. If you don't want to change the times for any fixtures, deselect them now. You can press the ALL button (below Next Time) to select all fixtures in the cue or Shift+ALL to deselect all fixtures.
 - 3> Press the softkey for the attribute group you want to change.
 - 4> Press A [Delay] to set the delay time, or press B [Fade] to set the fade time. Press G [Use global] to remove the attribute group timing and go back to the normal delay/fade times for the cue.
- You can use [Individual Attributes] to set times for one attribute within the group, for example just Pan from within the Position group. You can also use the Cue View window to set times for individual attributes.

10.5.4 FIXTURE OVERLAP

For each cue you can set a (linked together) fixture overlap, which causes Titan to apply the settings in the cue to each fixture sequentially giving a “rolling” change across the fixtures in the cue. This can create some great effects without much programming on your part.

- Press [Fixture Overlap] (on the second page of the Cue Times menu) then enter 0-100 on the keypad to change how fixtures overlap in the cue. 100% means all fixtures fade together (the normal setting). 0% means that the first fixture will finish its fade before the next one starts. 50% means that the 2nd fixture will start fading when the first one is half way through its fade.
- To change the fixture order when using overlap, press [Set Fixture Order]. Normally this is the order in which you selected the fixtures when you programmed the cue. The Fixture window shows the fixture order in large green numbers. Reorder the fixtures by pressing [Step Number] then type the start number on the numeric keys, then press the fixture Select buttons in the order you want them. For example, to set the order of 8 fixtures, press 1 on the keypad, then press the Select button of the fixture to be first, then the Select button for the second, and so on. You can set several fixtures to the same number if you want them to change simultaneously. If you press a fixture button twice, it will show X and be excluded from the sequence.

Press <Exit> to finish setting the fixture order.



10.5.5 RUNNING A CUE LIST TO TIMECODE

The console can run a cue list automatically to a timecode. This is very useful for complex performances which must be exactly the same time after time, or for unattended operation. Each step in the cue list is assigned a time at which it will run.

The console can have up to 4 separate timecode sources. For each, the timecode can be read from the system clock, from an internal timecode source, from MIDI, SMPTE or from Winamp. Internal timecode is useful for programming a sequence which will later be triggered by an external timecode source.

- 1> Connect the cue list for which you want to set timecode.
- 2> Press [Timecode] on the top-level menu.
- 3> Press softkey A to select Timecode 1-4, and B to select the desired timecode source.
- 4> Press [Record].
- 5> Start the timecode source. If using internal timecode, press [Play] to start it.
- 5> Press the red Go button to step each cue at the time you wish the cue to start.
- 6> Press [Record] when you have finished.

To play back a timecoded cue list, press [Connected Cue Lists] on the Timecode menu and select the cue list which is to be played. Then press [Timer Disabled/Enabled] to enable the timecode input.

When you start the timecode source (or press [Play] if using internal timecode), each cue will fire as the timecode matches its programmed time.

You can edit the timecode for each cue by using Wheel A to select the cue, then press <Enter> and type the new timecode for the cue.

ad	Curve	Autoload	Timecode	Notes	View
	Linear		00:00:00.24		VF
	Linear		00:09:00.00		VF
	Linear		00:12:00.00		VF
	Linear		00:25:00.24		VF
	Linear		23:59:59.24		VF
	Linear		23:59:59.24		VF

While editing a time you can also use Wheel B to select multiple cues, and use the softkey options to enter a value to change the time of all the cues (offset, add a fixed time or subtract a fixed time).

You can open a timecode display window for each of the four possible sources to show you the incoming timecode – press [Open Workspace Window] then [Timecode x] where x is 1 to 4.

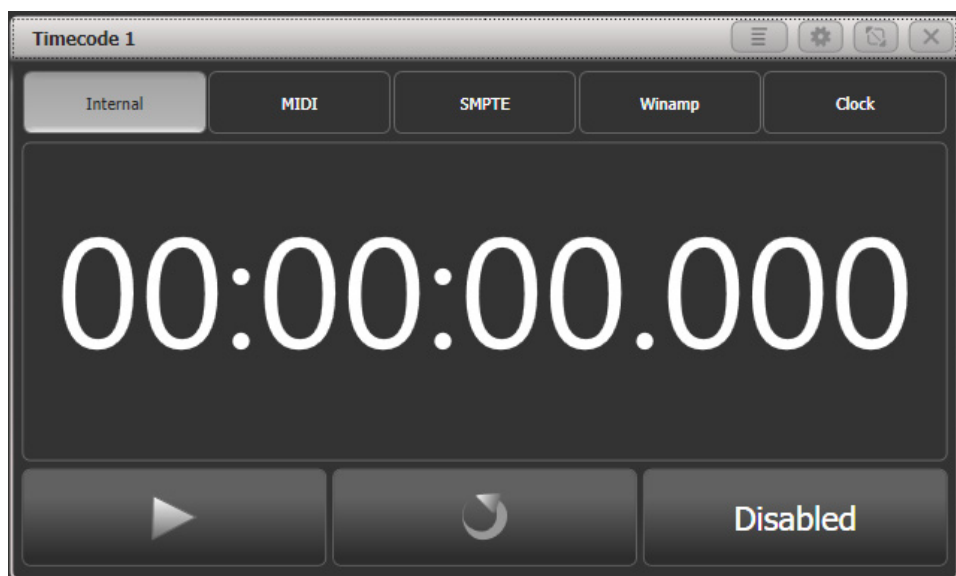

10.6 CUE LIST OPTIONS

Cue list options are set from the Playback Options menu. You can enter the playback options menu by doing the following

- 1> At the top level menu press [Playback Options].
- 2> Press the select button for the cue list you wish to edit.

You can show the cue list options in a window by pressing <View/Open> then the Select button of the cue list, then click the Options tab.

The Cue List options are mostly the same as for Cues and Chases, only the additional Cue List options are described here.

10.6.1 CUE LIST OPTIONS – PLAYBACK TAB

Most options are described in the Cues chapter on page 220, but these are extra options for cue lists:

Tracking: Enables or disables Tracking mode (where unchanged settings persist from the previous cues). Enabled by default.

Shape Tracking: Sets how shapes are tracked between cues.

Off – Shapes will stop when the next cue starts

On – Shapes will track until stopped or changed in a cue

Local – Follows the tracking option above (default option)

Move In Dark: Sets the mode for the whole cue list (see section 10.2.3 on page 243).

Off – obeys settings for individual cues (default option)

Disabled – no move in dark even if set in cues

Early – moves as soon as fixture is off

Late – moves in the last cue before the fixture is needed

Loop Action: Sets what will happen at the end of the cue list

Stop on final cue – Cue list will stop advancing once it reaches the last cue (default)

Loop – Cue list will go back to first cue after the last. If Move in Dark is enabled, this will also loop.

10.6.2 CUE LIST OPTIONS – HANDLE TAB

All these options are described in the Cues chapter.

10.6.3 CUE LIST OPTIONS – FADER TAB

Fader Mode: Sets how the cue list fader behaves.

Fader Mode Intensity Kill With Off - the fader masters the overall HTP level and the cue list remains active (connected) even when the fader is lowered to zero.

Fader Mode Intensity Kill At 0 - the fader masters the overall HTP level and the cue list is killed when the fader is lowered to zero.

Manual Crossfader - the fader behaves as a manual crossfade control, and the cue list will automatically step on to the next cue when the fader reaches the top or bottom of travel.

Fire first cue: Sets whether the first cue automatically fires when the fader is raised.

10.6.4 CUE LIST OPTIONS – EFFECTS TAB

All these options are described in the Cues chapter.

10.6.5 CUE LIST OPTIONS – RELEASE TAB

Release Mask and Release Time are described in the Cues chapter

Cue Release: allows you to create an overlay cue list with gaps in it where the fixtures will return to their previous state. For example you could create a cue list where every alternate cue sets the fixtures to white, with the in between cues being blank. If this option is on, the fixtures will bump to white then return to the colour set from a previous look.

10.6.6 RENUMBER ALL CUES

Allows you to renumber the cue list if the numbering has got mixed up after lots of editing. This is only available on the softkey options, not the touch window.

10.6.7 CUE OPTIONS

This option allows you to change settings for each cue in the cue list. To select the cue number to edit, use the left hand wheel or press softkey A then enter the cue number on the numeric keypad.

- [Curve] allows you to set a different fade curve for the cue; this affects how the fade progresses from one cue to the other (for example you can select a fade which starts off slow, speeds up in the middle and then slows down at the end). Press [Curve] then select a new curve from the softkeys. The effect of the various curves is described in section 16.6 on page 334.
- [Link] can be set to Wait for Go, With Previous Cue or After Previous Cue. See section 10.5.2 on page 251.
- [Move in Dark] opens the menu for Move In Dark options, see section 10.2.3.
- [Move In Dark Inhibit] disables the Move In Dark function for this cue.
- [Tracking] disables or enables tracking for this cue.
- [Legend] allows you to set a legend for the cue which is displayed on the cue list display.
- [Notes=] lets you enter a note for the cue (“Leaves stage pursued by bear” or “wake up spot operator”).
- [Autoload] see next section
- [Cue disabled] allows you to temporarily disable this cue, see section 10.3.8.

10.7 THEATRE PROGRAMMING QUICK GUIDE

If you are used to programming other theatre-style consoles, you will be more familiar with using a keypad/syntax style interface than the Titan touchscreen. But fear not because you can program a theatre show on Titan using the keypad and this is how you do it.

Labelled buttons on the console are shown like this: <Enter>. The <Cue> button is labelled <Connect> on some consoles. The <@> button is the one next to the numeric keypad.

Dimmers/Fixtures have a User Number (which is equivalent to the Channel Number on other consoles), shown in the top left corner of the fixture button. This is the number “n” shown in the keypad commands. You can change this number using the [Set Legend] softkey, see section 4.2.5. Groups also have a User Number.

User Number shown on fixture buttons



SETTING DIMMER/FIXTURE LEVELS

- n <@> <@> : Set fixture n to 100%
- n <@> v <Enter> : Set fixture n to v% (you need to enter 2 digits so “50” for 50%)
- n <Thro> m <@> v <Enter> : Set fixtures n – m to v%
- n <And> m <And> p <@> v <Enter> : Set fixtures n,m,p to v%
- <Group> n <@> v <Enter> : Set fixtures in group n to v%
- <Clear> : Snap release edited channels back to programmed state – like Cheat on ETC
- t <Clear> : Release edited channels fading over time t

SETTING OTHER ATTRIBUTES OF MOVING LIGHT / INTELLIGENT FIXTURES

- Select fixtures for control using
n <Enter>
n <Thro> m <Enter>
<Group> n <Enter>
- Press one of the Attribute Bank buttons <Colour> <Gobo> etc. The current function of the wheels is shown bottom right on the screen. Press the same Attribute Bank again to page through different attributes e.g. if there are 2 gobo wheels keep pressing <Gobo> to access the other attributes.
- Use the wheels to set the value. Or press the <@> button next to the wheel and type in a value on the keypad.

PROGRAMMING CUES

Titan can have multiple cue lists. To start a cue list press <Record> then select [Create Cue List] from the touch screen. Then press a blue button above the fader where you want to store the cue list.

Titan will record into the cue only dimmers/fixtures you have changed since you last pressed <Clear>, and that have changed from the previous cue (so if you put up another playback, that won't get recorded). To record everything with intensity above zero, switch [Record Mode] to “Record by Stage” (see section 8.1.2).

- <Record> {blue fader button} {blue fader button} : Record the next cue onto the end of the cue list on this fader
- <Record> <Cue> n <Enter>: Record cue n (will prompt for merge/overwrite if it exists already)

- <Time> t <Enter> : Set fade time into programmer (does not affect stored cues; will save with the cue when you record it)
- <Cue> n <Time> t <Enter> : Set fade time of cue n to t seconds
- <Delete> <Cue> n <Enter> <Enter> : Delete cue n (2nd Enter confirms)
- <Copy> <Cue> n <@> <Cue> m <Enter>: Copy cue n to new cue m
- <Copy> <Cue> n <@> <Enter> : Copy cue n onto the end of the cue list
(Can also use <Move> to move cues, and <Thro>, <And> to change multiple cues)

You can show the list of cues on screen, click on individual times to edit them:

- <View> {blue fader button}

To make a Block cue (changes do not track), view the cue list as above, in the Tracking column click the cell for the cue you want to change and select [Block] from the softkeys.

To link cues, the easiest way is on the screen. Click on the "Link" cell (which normally shows "Wait For Go". Then select from the softkeys [Link After Previous Cue] or [Link With Previous Cue]. For Link After, set the "Delay Out" time to set how long the cue will remain before the next cue starts.

RUNNING CUES

Push up the fader of the cue list to make it active ("connected").

If another cue list is active: <Cue> {blue button} : Connect this cue list as the current list.

- <Go> : Run next cue with programmed times
- <Cue> n <Go>. : Go cue n with programmed times
- t <Go> next cue go with fade time t
- n <Cue> t <go> jump to cue n with fade time t

If you want moving fixtures to automatically position themselves ready for the next cue, enable the [Move In Dark] option, see previous section. This is Off by default.

EDITING CUES WHILE RUNNING

Often you need to make changes to cues while the cue is active in a running show. Press <Clear> before you make changes to be sure that the programmer does not contain any previous changes.

- <Record> <Cue> <Cue> : Update current cue by merging programmer
- <Time> t <Enter>, <Record> <Cue> <Cue> : Set fade in time of current cue
(It is probably easier to use <View> and click on the time on screen to edit it)

EFFECTS / SHAPES

You can't select Effects/Shapes from the keypad on Titan, but it's still easy.

- Select fixtures for control
- At the top level menu press [Shapes and Effects], [Shape Generator], [Create]
- Select the type of shape [Dimmer], [Pan/Tilt] etc
- Select a shape from the softkeys or from the Shapes window which appears.

- Set the Speed, Size, Spread using the wheels

Shapes will record into cues, and will track through subsequent cues while they are active in the programmer, until you stop them by pressing <Clear>.

11. CAPTURE VISUALISER

From Titan v10, the Capture visualiser is integrated into the console. This can provide a realistic simulation of your lighting which is really useful for pre-programming or making changes in blind mode during a show.

This chapter also has a section on linking the console to an external full version of Capture.

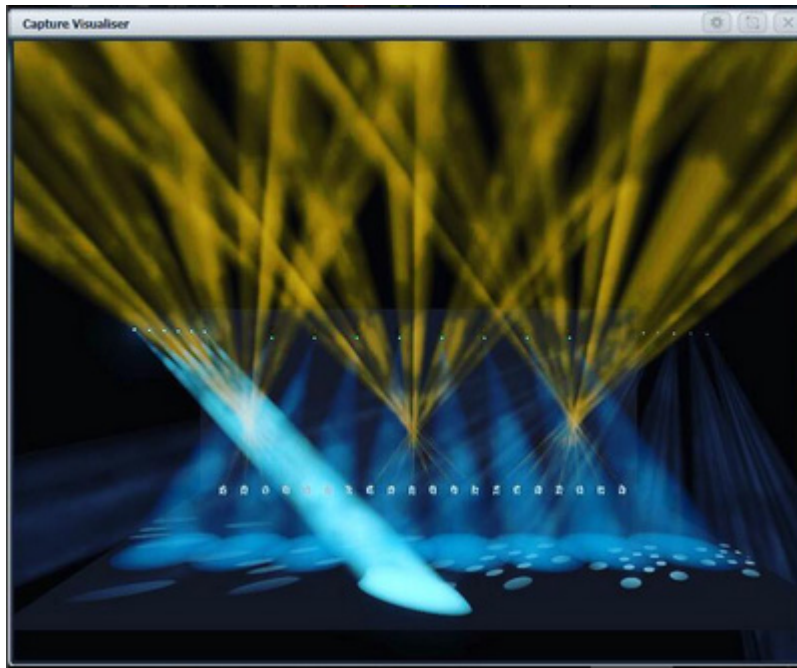

To open the visualiser, select [Capture Visualiser] from the [Open Workspace Window] menu.



Always pre-program using palettes, because things never quite line up the same in a visualiser as they do in the real world. Using palettes means that you just need to reprogram the palettes when you get onto the real rig, rather than having to change lots of cues separately.

11.1 SETTING UP THE RIG

11.1.1 SETTING UP THE STAGE AND RIGGING

To help you see what your rig will really look like you can add fixed elements of staging and rigging.

Open the Capture Visualiser Settings window from the Open Workspace Window menu, or the Open Settings context button in the Capture window. Click the Stage tab.

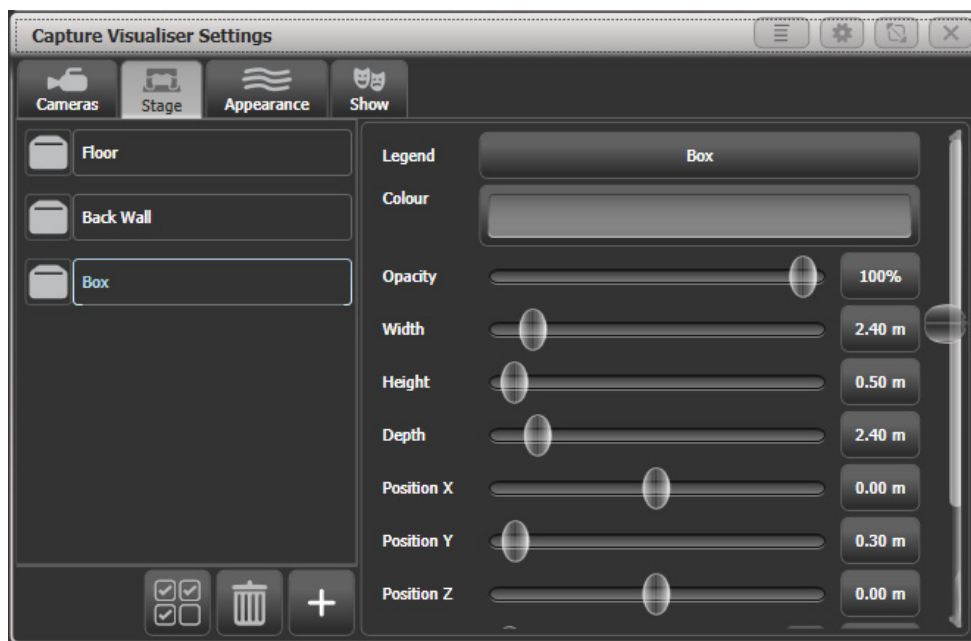

“Floor” and “Back Wall” are provided by default. You can add other objects by clicking the Plus button at the bottom of the list.

Click on the object in the list on the left hand side to position and angle the object using the controls on the right. You can either type exact numbers by clicking on the buttons down the right hand side or use the sliders. You can set a legend and colour for each object.

11.1.2 SETTING UP FIXTURES

Fixtures are automatically placed into the visualiser when they are patched if the Auto Update switch in the Capture Settings “Show” window is set to On.

If you load a Titan show from a previous version, or have some patched fixtures which are not placed in Capture, use the [Edit Fixtures] [Update Personality] option on the Patch menu to place missing fixtures into the visualiser. The Exchange Fixtures function may also be used to help with this situation.

Fixtures are positioned using the wheels. Select one or more fixtures using the Fixture select or Group buttons and turn them on by pressing Locate. Press the [Position – Orientation] context menu button to switch the wheels to Visualiser mode (or press Softkey G at the top level menu until the display shows Wheels-Visualiser.)

Select Position attribute, then use the wheels to change the X/Y/Z position of the fixture(s). If you select multiple fixtures, pressing the [Scale-Fan] context menu button or the Fan button allows you to evenly spread out the fixtures. The Fan curve/group/split options also work.

Touch above or below the wheel value to nudge the setting up or down by one step. For rotation this will be 45 degrees.

If you are viewing the stage from the front then

X moves left and right

Y moves up and down

Z moves towards and away from you

Press the Position button again to switch the wheels to Orientation mode. The wheels will now pivot the fixtures in the X/Y/Z axes. Again you can use the Fan button to give a spread of angles on multiple fixtures.

The X/Y/Z rotation operates like a 3-axis camera gimbal – imagine the fixture within three pivoting rings (see left hand picture below). In some orientations, the X and Z rotation will seem to do the same thing and some rotations seem to be impossible to achieve – this is called gimbal lock and happens when two of the “rings” are lined up with each other (right hand picture below). Change the Y rotation by 90 degrees to enable you to achieve other angles.

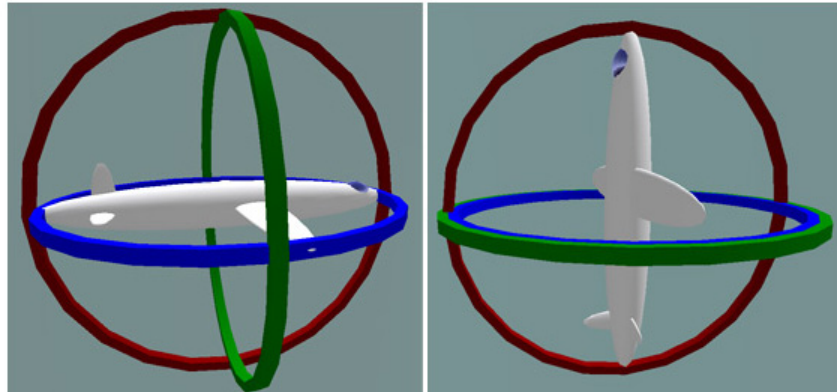

Illustration by MathsPoetry

Press the Position button a third time to switch the wheels to Rotation mode. This is similar to Orientation but if you have multiple fixtures selected, the fixtures rotate as a group about the middle fixture.



It's easier to see what position fixtures are in if you change the tilt angle so they aren't pointing straight down (or up). It's always useful if you can have an actual fixture of each type connected to help you get them pointing the right way, but you can change this later if not.

11.1.3 SETTING UP CAMERAS (VIEWS)

Four cameras (selectable views) are provided by default but you can add more.

The context menu buttons provide camera options.

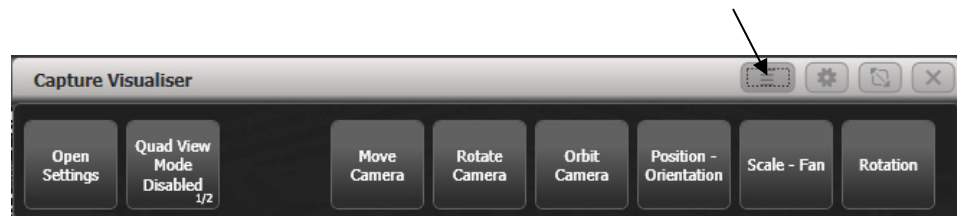

Camera controls are in the Capture Visualiser Settings window which you can open using the [Open Workspace Window] button or using the [Open Settings] context button.

The view buttons across the top select the four default views. Press the Plus button at the right hand side to add a new view.

The top button on the left toggles between single view or quad split mode. If quad split is selected, the other 4 buttons select which view you are controlling.

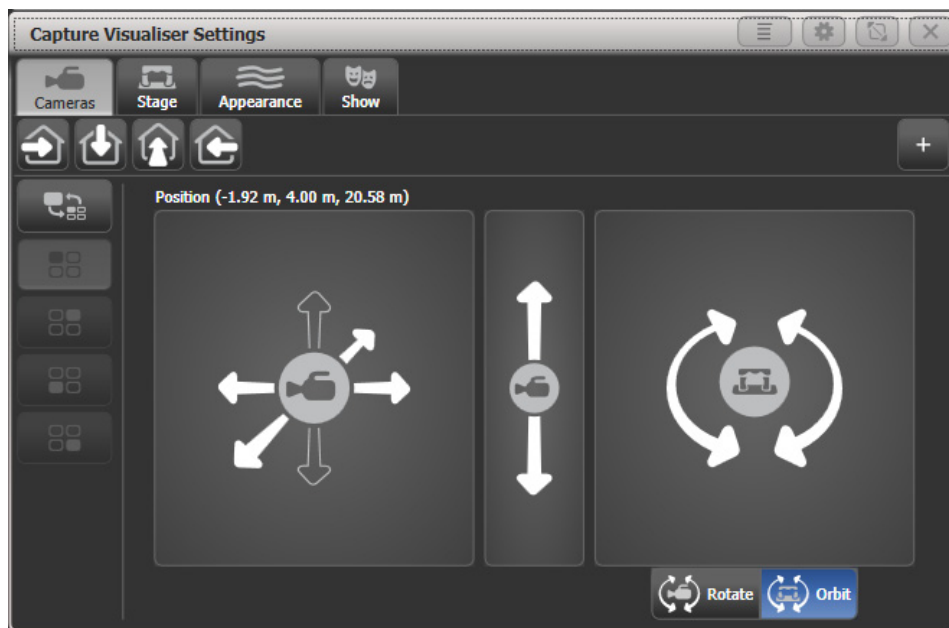

The left hand pad moves the camera left and right, and towards and away from the stage.

The middle pad moves the camera up and down.

The right hand pad can be set to rotate or orbit mode

- Rotate: turns the camera to face left, right, up, down
- Orbit: orbits the camera around the stage in a circular path keeping it pointed at the same object.

Press the [Move Camera] context button to link camera movement to the wheels. This also opens the Set Coordinates menu with softkeys allowing you to enter numeric camera positions.

Press the [Rotate Camera] or [Orbit Camera] context buttons to link camera rotation or orbit to the wheels and allow numeric entry on the softkeys.

11.1.4 CAPTURE APPEARANCE OPTIONS

The Appearance tab of the Settings window allows you to set the following parameters:

- Ambient lighting (background light level)
- Smoke density (called Atmosphere in full Capture))
- Smoke variation (also called Atmosphere contrast - mix between haze and moving smoke effects – 0%=all haze, 100%=all smoke)
- Smoke speed (also called Atmosphere speed - rate of change of moving smoke effect)
- Exposure adjustment (camera brightness control)
- Bloom amount (visible halo around lights)

- Rendering settings detail (this affects the refresh rate of the simulator. If you have a lot of beams visible you may need to change this to Low to improve the refresh rate).

11.2 VISUALISING USING CAPTURE

Mostly you don't have to do anything special with Capture once you have it set up. Just operate the console as normal and Capture will show you what would be happening on the stage.



If you use the visualiser a lot, it's very handy to have an external monitor to show it on. Otherwise you constantly have to switch between the workspace windows and the visualiser window.

11.2.1 FIXTURE SELECTION

If you select fixtures on the console, the fixtures will highlight in Capture so you can see where they are in real life.

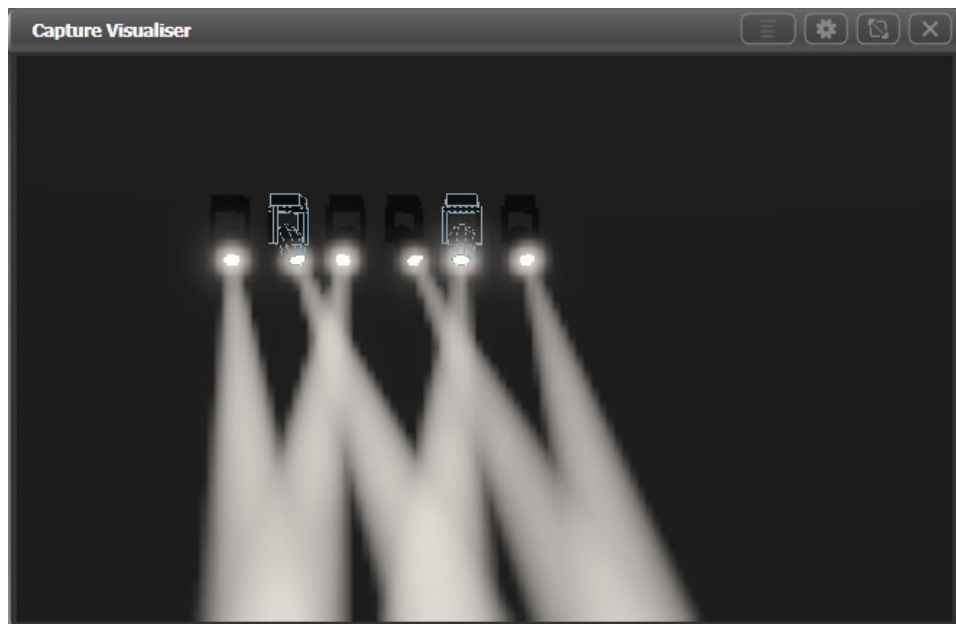

11.2.2 CAMERA VIEWS

Capture lets you see how the lighting will look from any seat in the house. Even if you're in the venue with the full rig in front of you this means you can see the look without having to run all over the venue.

Set up multiple cameras as described in the previous section and you can either click between them or show the 4 standard camera views as a quad split.

11.3 CAPTURE SHOW FILES

The Capture stage is automatically saved within the Titan showfile. The Capture stage can also be exported and imported separately from the Titan show. This allows standard

stages or rigs to be transferred between Titan shows, or to be loaded into the full version of Capture for further editing.

Select the Show tab in the Capture Settings window to export and import shows.

11.3.1 EXPORTING SHOWS

Exported Capture shows can be loaded into other Titan shows or into the full version of Capture for producing documentation.

11.3.2 IMPORTING SHOWS

Shows can be imported from the full version of Capture, this can be useful to import existing stage structures or rigging designs.



The internal Capture engine uses the Capture 2018 version (prior to Titan v12, Capture Atlas was used). You will not be able to import files from newer versions of Capture - use the "Export for Capture 2018" function in the File menu of the full version of Capture to save the file as a version which can then be imported.

You can import fixtures from full Capture but you need to ensure that fixtures are correctly patched in Capture to match the patch on the console. There is no way to edit an externally created Capture patch on the console.

Some fixture types and other Capture elements may not work when you import a show that has been created in full Capture. We recommend you use the auto-patch function to allow the console to patch the fixtures into Capture.

11.3.3 CLEARING THE CAPTURE SHOW

The Wipe button at the bottom of the Show tab will clear the current Capture show.

If you need to reload patched fixtures from your Titan show into Capture, select the [Edit Fixtures] [Update Personality] option on the Patch menu. This will place all patched fixtures from the Titan show into the visualiser.

11.4 LINKING THE CONSOLE TO STAND-ALONE CAPTURE

Sometimes the extra capabilities of the full version of Capture are needed, and the console is linked to a PC running full Capture. The fixture patch details and fixture selection will sync between the console and Capture.

When the PC is connected to the same network as the console, you should be able to see the console listed at the bottom of the "Universes" tab in Capture. The console should link automatically, but if not or if there are multiple Titan consoles on the network, you can manually select one from the list.



For linking/sync to work properly the external Capture version must be the latest version of Nexum, or 2018. Older versions of Capture will only partially work.

While Capture is connected, the console will attempt to keep its show synchronised to the Capture show. If you add a fixture or change patch details in Capture the changes will automatically be made on the console. If you add a fixture or make changes to the patch on the console, then Capture will update. Selecting a fixture on one will select the fixture on the other. If you don't want this to happen you can turn off the "Console Link" function in Capture.

11.4.1 PATCHING CONSOLE FIXTURES INTO CAPTURE

When you first connect the console to Capture, or if you load a show on the console or patch a new fixture, the Console Patch dialog will be shown in Capture. This contains a list of the fixtures which are on the console and need inserting into the Capture show.

You have to drag the fixture(s) from the Console Patch window to one of the Capture viewports to place it in the Capture show, the DMX address will be set from the Titan show. You can select and drag multiple fixtures.

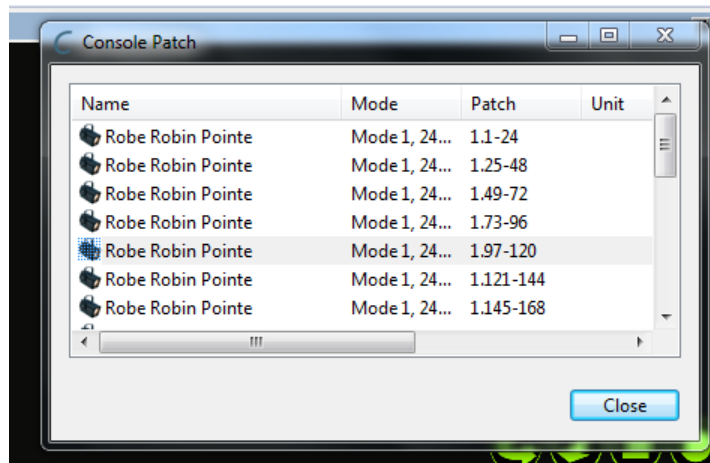

Fixtures already placed in the internal Capture simulator will appear in the same position and orientation in the stand-alone Capture. Changes to position, orientation, legend and user number will sync between the console and stand-alone Capture.



Fixture Legend in Titan links to the "Unit" property on the Capture fixture, and User Number in Titan links to the "Channel" property in Capture.

11.4.2 PATCHING CAPTURE FIXTURES ONTO THE CONSOLE

If fixtures have already been added in Capture before the console was linked, you can patch them on the console using Active Fixtures like this

- 1> Press <Patch>, [Active Fixtures]
- 2> You should see the Capture computer as a softkey option, press it
- 3> Select an empty handle to start patching, or press [Patch Capture @ ...] to patch automatically
- 4> If any fixtures can't be patched (unsupported fixture type, or duplicate user number) then a blank handle will be left and a warning softkey will be shown at the end; clicking this will show a list of problems found.

To fix duplicate user numbers, edit the value in the “Channel” field in Capture to be a unique number. To fix unsupported fixtures, first try updating your Titan fixture library. If this doesn't help, you can submit a personality request on the Avolites website and select “Capture Visualiser (.c2o)” from the Desk Type options.

12. SYNERGY AND LINKING TO AI

From v12, Titan includes Avolites Synergy software which allows you full control over one or more networked Ai media servers. Not only can you control playback of media and effects, but also upload new media to the server with automatic transcoding, create new screen fixtures and new layers on them, and preview multiple media streams in the Titan workspaces.

For shows which include video content, this gives you a much smoother workflow when creating and running the show.



Ai refers to media outputs as “Screen Fixtures”. To avoid confusion with Titan fixtures, Titan doesn’t use “Fixture” and refers to them as “Screens” (and in some places “Surfaces”).

12.1 SETTING UP

12.1.1 CONNECTING UP

The Ai server(s) need to be connected by Ethernet to the Titan console. Media previews use NDI streams which along with copying of large media files can place a heavy demand on the network, so you should follow these tips for setting up a suitable network:

- Use at least gigabit network equipment
- Have a dedicated network for Synergy if possible
- If you are using Titan Mobile, make sure Windows Firewall is turned off

If you have problems getting Titan and Ai to recognise each other, make sure they are on matching software versions, and both in the same IP address subnet range such as 2.0.0.1 and 2.0.0.2

12.1.2 SETTING UP THE AI SHOW

A simple Ai system involving a single screen or projector can be set up by following the Synergy setup instructions in the next section. You just need to open a blank show in Ai and you can add Screens and Layers from the Titan console.

For more complicated requirements, create suitable screen fixtures in the Ai show – see the Ai manual for more details on how to do this. You can create and rename Layers from the Titan console. The screen fixtures you have created in Ai will then become available as Surfaces in Titan.

12.1.3 SYNERGY SETUP

In Titan, open the Synergy Settings window using the Workspace button provided on new shows, or use the option in the Open Workspace Window menu.

This window is a little like the DMX settings screen: it lets you set up how the Titan console is linked to the various outputs on the Ai server(s). Also, it lets you add or

remove layers from each Ai surface and add complete new surfaces to the Ai server (though you may need to configure these further on the Ai server itself).

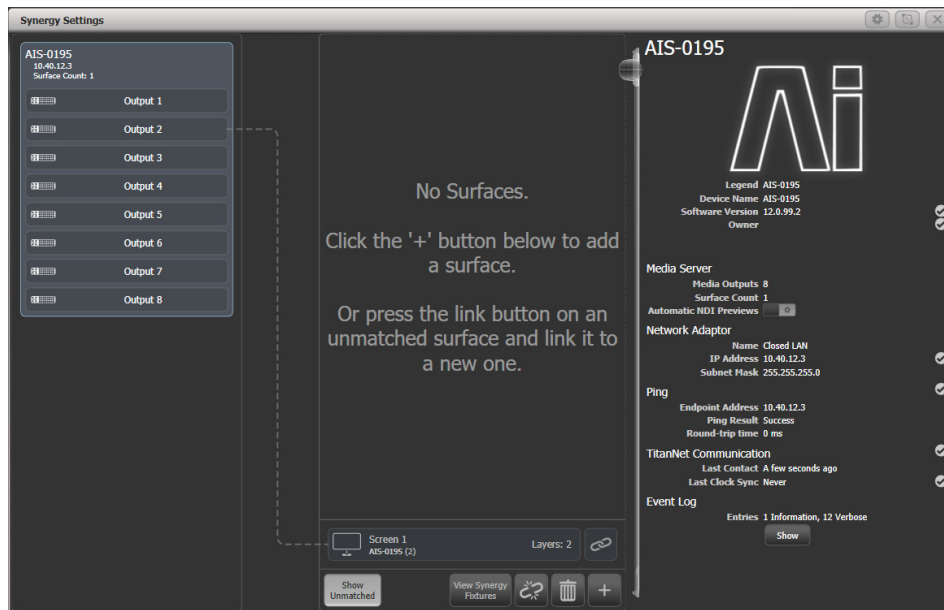

On the left of the screen the available Ai servers are shown. In the centre of the screen, the Surfaces and Layers configured in Titan are shown. Connection lines show how the Titan Surfaces will control the different outputs of the Ai server. At the bottom are Surfaces which are already configured on Ai but are not yet linked to Titan, these are called unmatched surfaces.

Click on the + at the bottom and select Surface from the pop up to add a new surface. This will appear at the top; by default it has two layers but you can change this later.

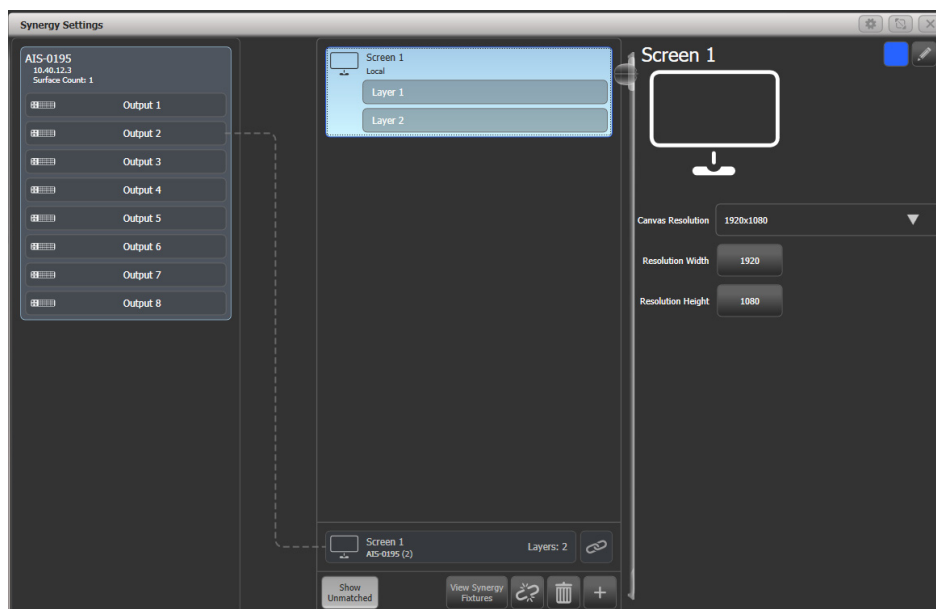

Clicking on the top part of a Surface will show options on the right for the surface. These options allow you to set the canvas resolution which can either be picked from a list of common resolutions, or entered numerically; at the top right the display halo colour of the surface can be set, and the pencil button allows you to change the name (you can also do this with the [Set Legend] button).

Clicking on a Layer within a Surface shows layer options on the right. This allows you to allocate a Rate or BPM master to the layer for speed control.

When no Surfaces or Layers are selected, the right side of the screen shows general information about the system. There is a switchable option “Automatic NDI Previews” to enable or disable NDI streams – if you are using the media preview window, you will need to turn this on. If not leave it turned off, as it causes a lot of network traffic.

Once you have created a surface in Titan, you need to match it to the Ai surface. Click on the Link button on the unmatched surface at the bottom, then click on the Screen 1 surface at the top (or you can click “Link to new Surface” to automatically create a new surface and link to it).

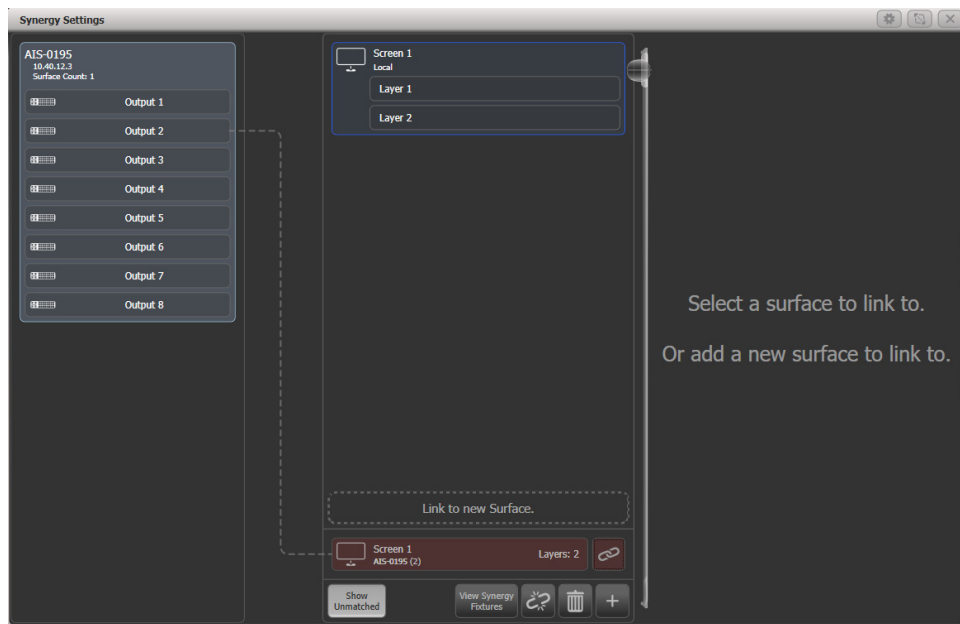

The Screen 1 Surface will now show that it is linked to the Ai server, and the unmatched server at the bottom disappears.

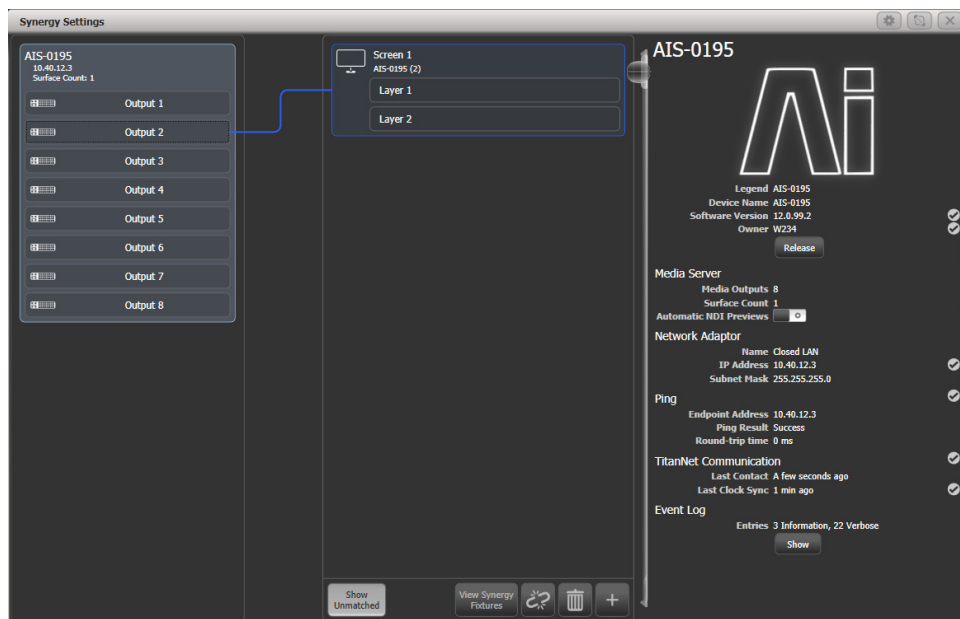

You can link the Screen 1 Surface to one or more different physical outputs on the Ai server by clicking the screen, then clicking the output to connect on the left, for example if you want to show the same media on several screens.

Once a layer is linked, if you open the layer properties in Ai the “Synergy Control” box will show “Enabled”. Now you cannot control the screen using Ai, only from the Titan console.

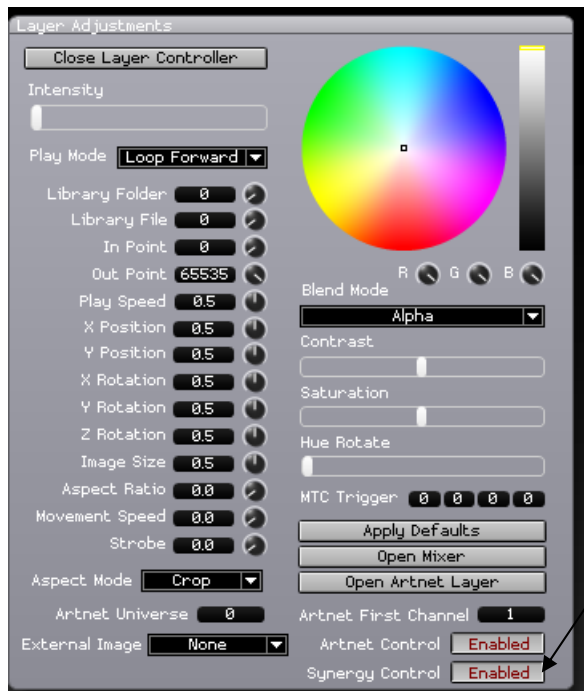

To add a layer, click on the surface, then the plus button at the bottom and select Layer from the popup.

To delete a layer or surface, select the item then click the Trash Can icon at the bottom, or press <Delete> then click the layer/surface. If linked to Ai, this will also delete the layer/surface in Ai.

12.1.4 SYNERGY FIXTURES WINDOW

Every layer on the Ai server appears as a button in the Synergy Fixtures window. You can display this using the button at the bottom of the Synergy Settings window or from [Open Workspace Windows].

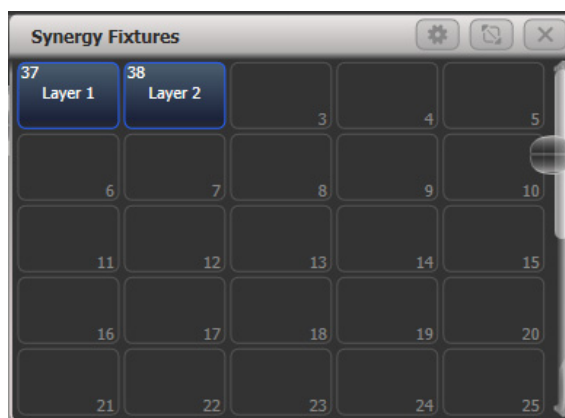

You use these buttons to select one or more layers for control, just as you would select lighting fixtures to control. Once selected, use the Attribute Editor or wheels to control the media playback and effects on the Ai server. You can then store palettes and playbacks as with any other lighting fixture. This is described in section 12.2.3 in the following pages.

- The Synergy layers are shown in their own window to keep them together and help you find them quickly. However if you prefer you can move the layer buttons into the normal Fixtures window.

12.2 OPERATING SYNERGY

Once Titan and the Ai server(s) are linked up, you can start controlling Ai from the console.

12.2.1 UPLOADING CONTENT WITH THE MEDIA BROWSER

The Media Browser allows you to upload media content directly to the Ai server from the Titan console. You can also create new media banks on the server. Media content will be automatically transcoded to the AiM codec as required by the Ai system. This is very handy when you are handed a last-minute media file at the front of house position.

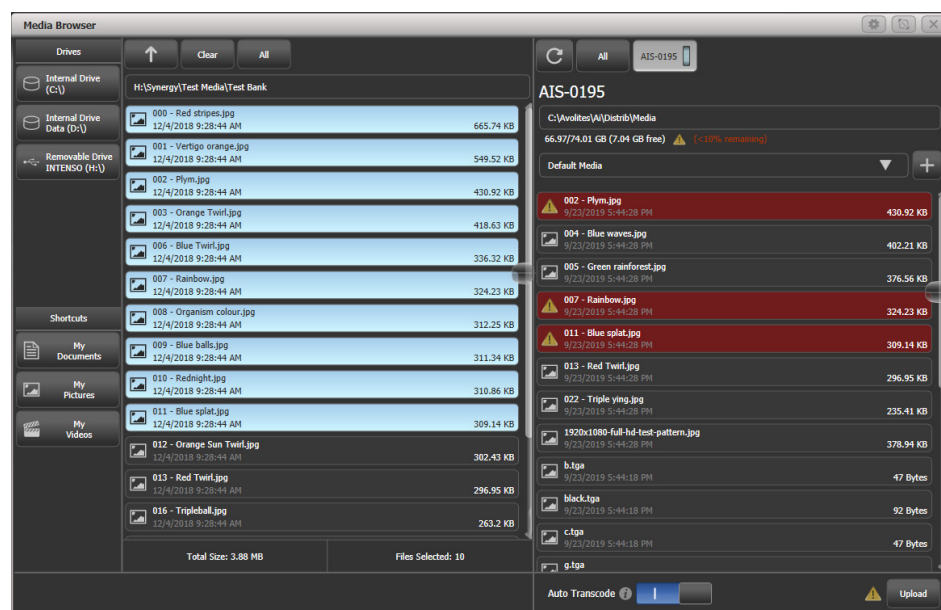

On the left hand side of the screen, local disks available on the console are listed. If you plug in a USB drive it will be shown here. Shortcuts to commonly used folders are also provided.

In the second column, the files/media clips available on the selected local disk are shown. You can navigate into folders and use the up arrow at the top to go back up a folder level.

On the right of the screen, the media banks on the Ai server are shown. Clicking on the bank name will drop down the list of media clips loaded in the bank. Click the plus button at the side of the bank name to add a new bank. At the top of this column, the

available disk space and the path on the Ai server where the media is being stored is shown.

To copy media files to the Ai server, select the files you want to transfer in the middle window, then click on the bank you want to transfer them to on the server.

If the Ai server already has files on it with the same names as files you have selected for transfer, the files will be highlighted in red in the Ai server window as a warning.

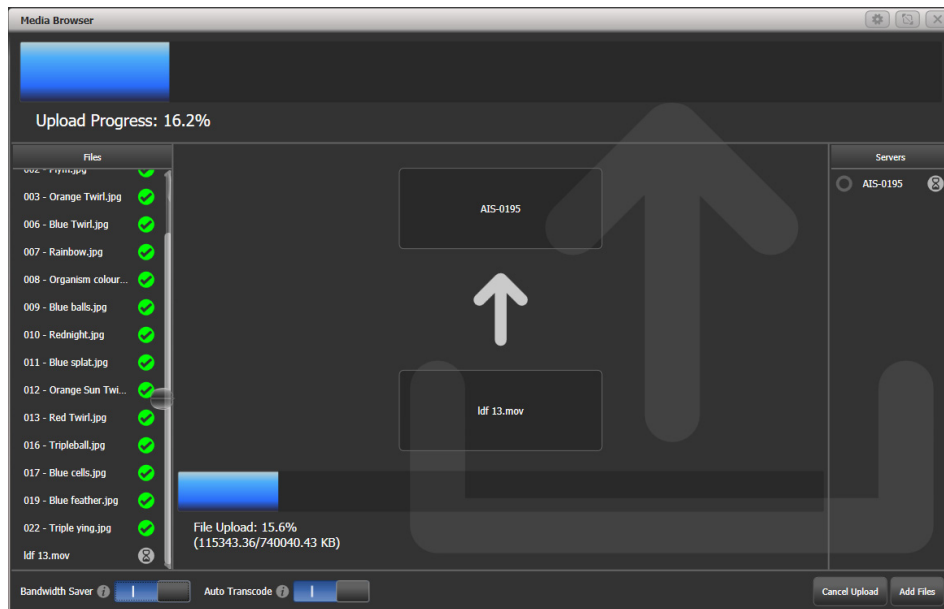

Synergy will attempt to transfer the files as fast as it can and will show you a progress screen. This may slow down the network; if this will be a bad thing, turn on the “Bandwidth Saver” switch at the bottom of the screen to throttle the file transfer and leave capacity on the network for other traffic (obviously this will slow down the file transfer).

You can also turn off the automatic transcoding to AiM codec, but normally we would recommend that this option is left on. Once the files are uploaded, any requiring transcoding are added to a queue in Ai. You can see the progress of the transcoding by viewing the clips in the Attribute Editor, see next section.

12.2.2 MEDIA VIEWER

The Video Multi View window allows you to view any of the layers being produced by the Ai server, or any of the combined surface outputs. In addition you can view any other NDI streams available on the network, so for example at a broadcast event the broadcaster could feed you the program output or individual cameras to check lighting levels.

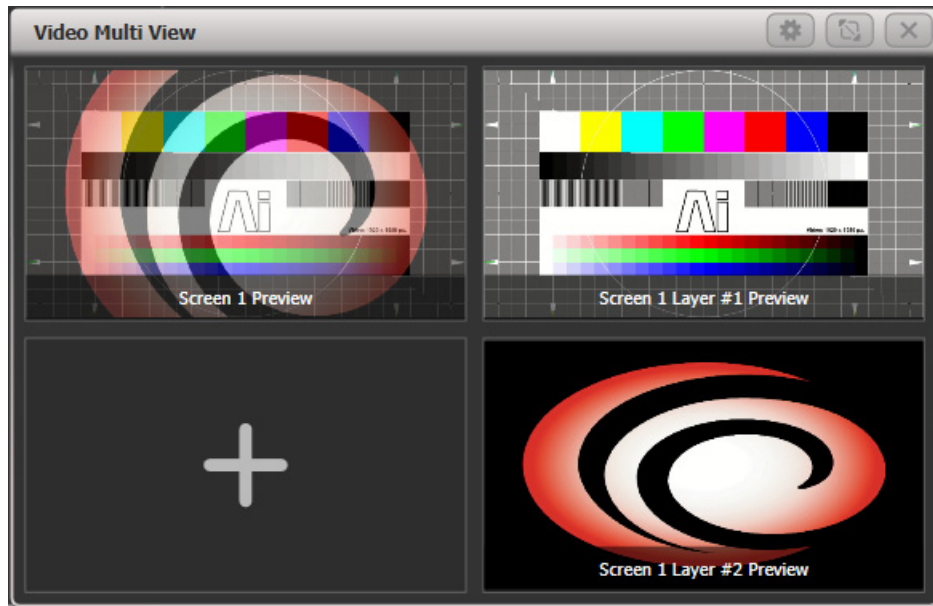

To add a stream, click on a view in the window (blank views show a plus symbol). A screen will pop up showing you all available streams on the network – either direct views of the layers, or a view of the output screen with the layers combined.

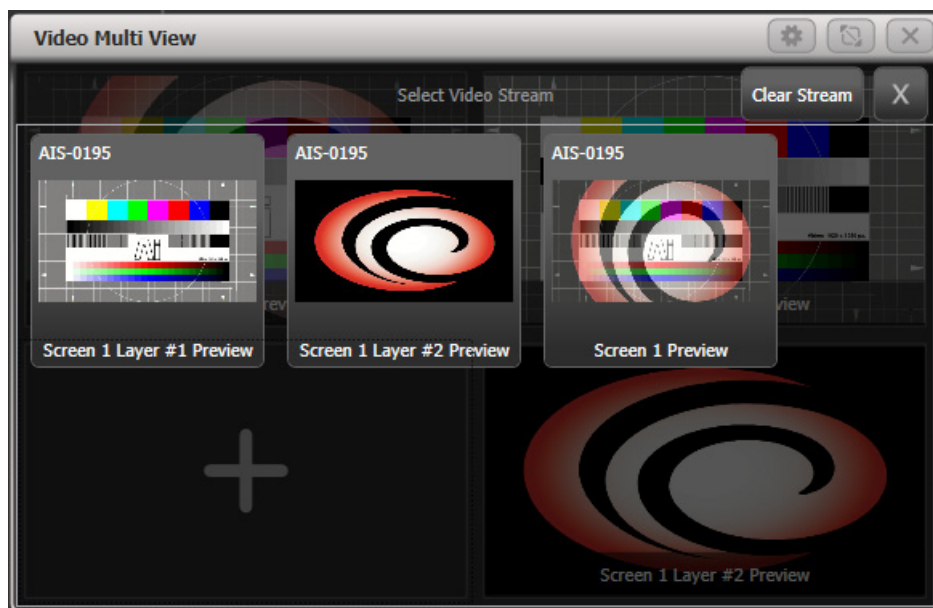

The context button [Change Layout] gives you various possible layouts of multiple screens. The [Titles Shown] button toggles to show or hide the stream titles at the bottom of the views.

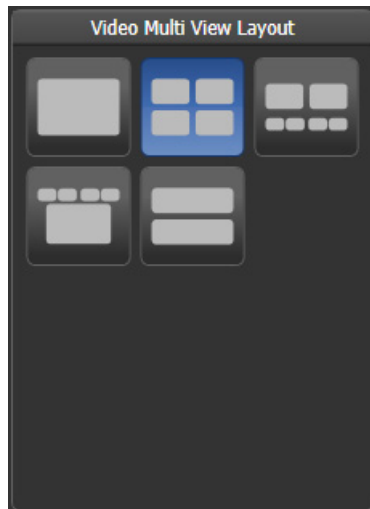

You must have the “Automatic NDI preview” option enabled for the Ai server in the Synergy Settings window for this to work.

The NDI streams used for video preview can use a lot of network bandwidth which limits how many streams you can receive at one time. The data rate varies depending on the detail/movement in the video but a rough guide is:

1920x1080p30	120Mbps
1920x1080p60	200Mbps
3840x2160p30	280Mbps
3840x2160p60	480Mbps

12.2.3 ATTRIBUTE EDITOR FOR CONTROLLING AI LAYERS

Once you have selected one or more Ai layers to control from the Synergy Fixtures window, the Attribute Editor lets you play back and manipulate media on those layers (you can also use the wheels and Attribute Bank buttons).

The most important attributes are Intensity, which set the output level of each layer, and Media Selection which lets you choose the Bank and Clip to play. But you can also control all other functions of Ai such as adding Fx and colour.



- In the Media selection screen, in the Clip tab, if you click on the “t” button or the caption at the top of the tab, this will toggle the clip name display on and off. This can be useful for long names which obscure the picture; on the other hand if you have lots of clips which look similar, the name display can be useful.
- Some of the attributes, such as Fx Select, have a large number of options which initially are shown in a vertical column of buttons requiring a lot of scrolling to see all the buttons. If you click in the header above the buttons, the column will expand to fill the window, making selection easier.



- In the Fx attributes, the effects names are pulled live from the Ai server. This means the names you are shown will always match what’s on the server. It’s also good for generative plugins where you define the Fx names.

i If you select layers then press <Locate>, the layer intensity will be set to full but all media and fx will be cleared. This is useful to get a layer back to a known state, but you don’t get any output. To get some output you will need to then select a media clip.

- The Clip selection window also shows you the progress of clips being transcoded by the Ai server.

Currently being transcoded

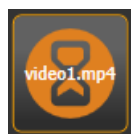

In the queue awaiting transcoding

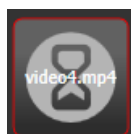

Transcoding failed



- You can create palettes to control Ai, just like with any other fixture. So colour, zoom, position and so on can be stored in a palette and used to quickly modify the appearance of the media. Palette fade times will also operate as you would expect.

12.2.4 LIGHTMAP: PIXEL MAPPING AI MEDIA CONTENT

Often you might want to output video content to lighting fixtures patched on the console (for example if you have LED screens with fixtures around or in between them). The pixel mapper can directly play back media clips from the Ai server. These can be sourced from individual layers or from surfaces (combined layer outputs). The surface outputs do not need to be connected to a physical output on the Ai server.

You need to use the Layout Editor to tell the console where the fixtures are positioned in real life so it can map the correct part of the video to each fixture, which is described in the next section.

Using Attribute Editor, start a media clip playing on the surface you want to use.

Select [Shapes and Effects], [Pixel Mapper]

Select a group to play back on

Add an effect using the + button

Select Ai feed using the Ai button.

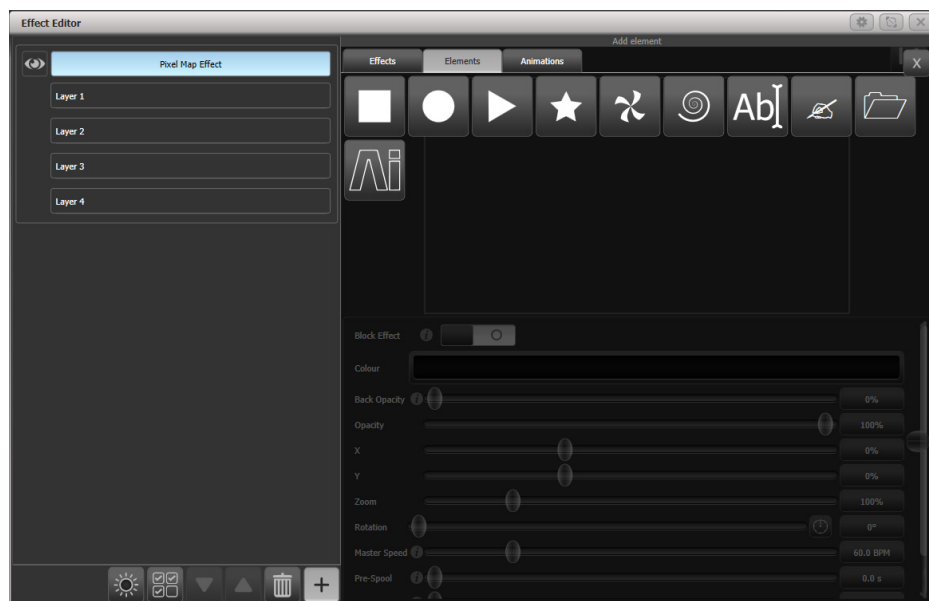

Select the surface you want to take the media from using the Source Surface option.

You can also adjust the colour balance using the Red/Green/Blue sliders.

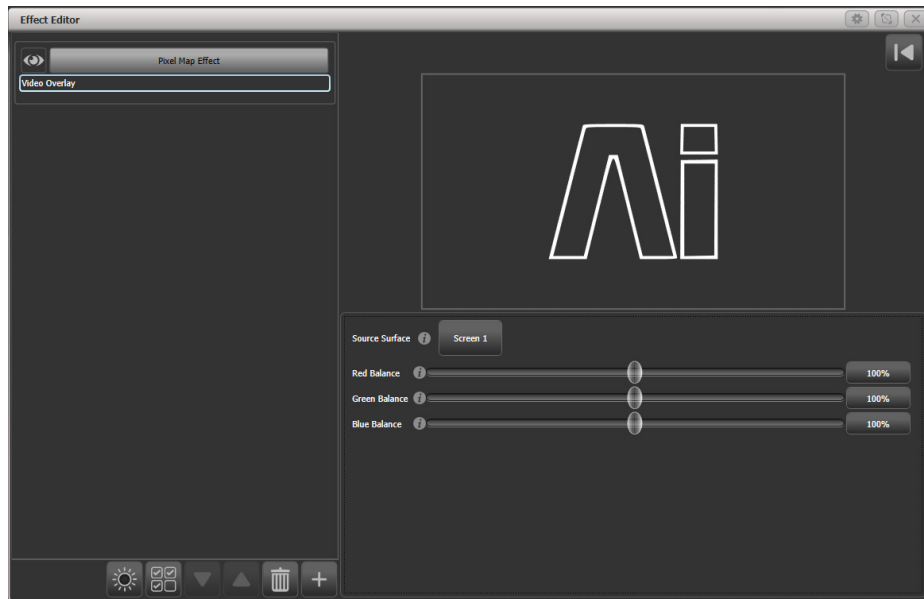

The media clip you selected earlier should now be playing back over the fixtures you selected. The pixel map effect is now linked to the Ai surface so you can change the clip which is playing using Attribute Editor or from programmed cues and you will see the change on the fixture outputs.

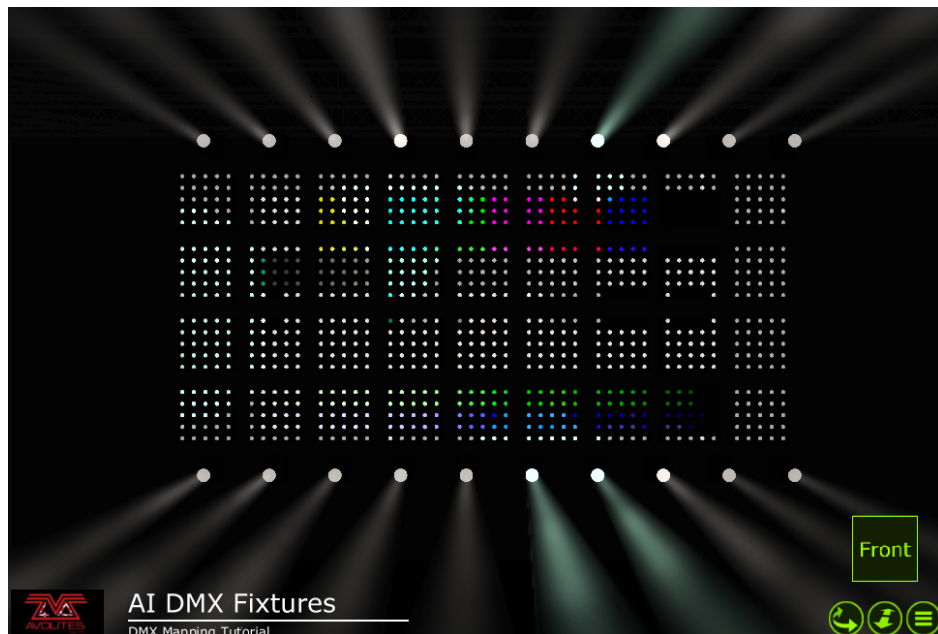

12.2.5 LAYOUT EDITOR WITH AI SERVER

The basic operation of the Layout Editor is described in section 5.3.2 on page 135.

The layout editor has some additional functions in the [Media Options] context menu which are useful when setting up fixture layouts for use with media content.

Show Video Overlay: you can select any layer or surface to be overlaid on the fixture layout grid to help you see where fixtures need to be positioned.

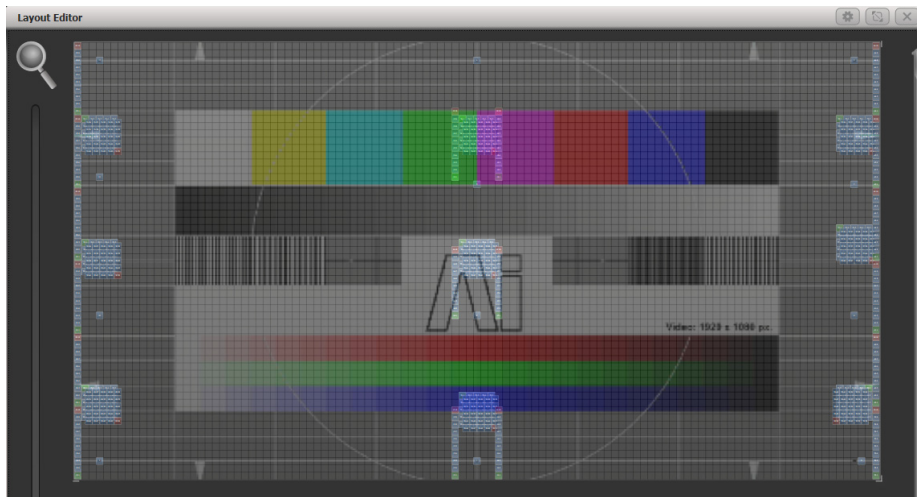

Sample Region Overlay: if the AI output has sample regions defined, for example when areas of LED screen are interspersed with fixtures, this option displays the sample regions overlaid on the layout grid.

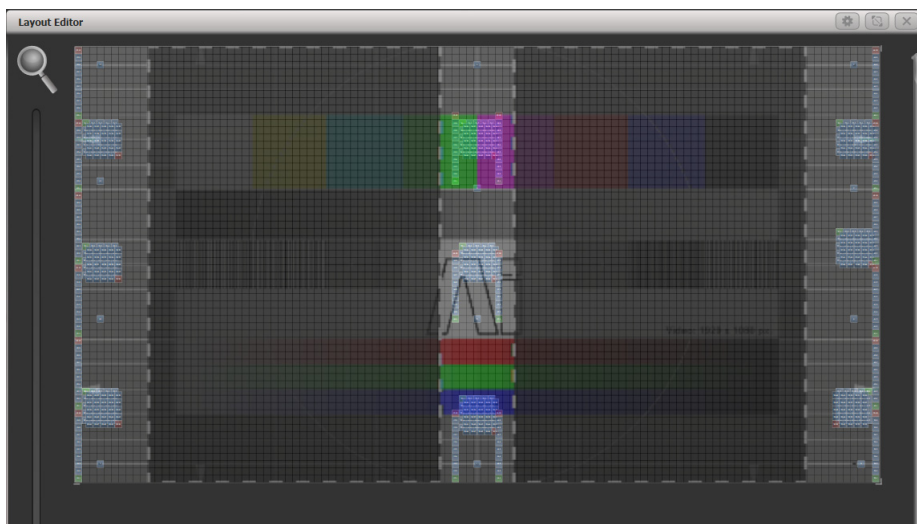

Position Overlay: with this option turned on, when you select a fixture in the layout editor, crosshairs will be displayed on the actual Ai output. This helps you to accurately position the fixture in the layout editor to match where it is in real life.

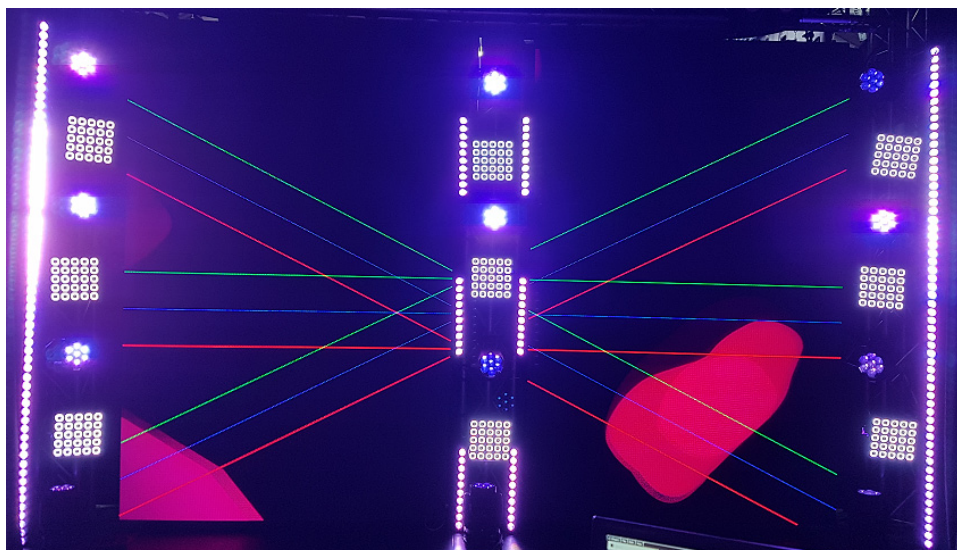

Match Surface Resolution: Allows you to match the layout grid to the resolution or aspect ratio of a surface. When you click this, you will be shown a list of the Ai surfaces available. Select one of these and softkeys will be shown for [Width] and [Height], set to the canvas resolution of the surface. You will not normally want to set the layout grid to match the video pixels 1:1 as fixture pixels are usually much larger than video pixels. But if you change the Width or Height, the other value will be automatically set to preserve the aspect ratio of the surface, so this function is useful to change the grid while keeping the correct ratio.

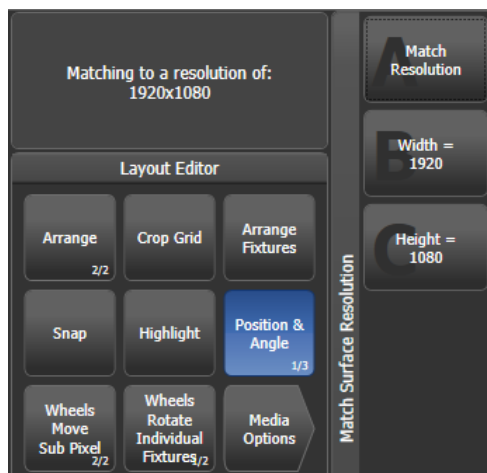

You can also scale fixtures in the Layout Editor to reflect real life size, as the default cell layout from the fixture's personality might not match other fixtures. Toggle the [Position and Angle] context menu button until it shows [Fixture Scale]. If a multi-celled fixture is scaled down to minimum size, the cells will disappear and it will act as a single cell.

12.2.6 PHASE CONTROL OF KEYFRAME SHAPES FROM AI

You can control the phase of Keyframe Shapes using the intensity of a video layer from Ai. This allows you to create some weird and wonderful effects as you can make the lights do pretty much anything in response to the video signal. The phase is controlled from 0-360 degrees as the video intensity where the fixture is located goes from 0-100%.

Once your Keyframe Shape is created, go to the Phase Master option at the bottom of the shape options screen and select the Ai screen you want to use as the video source.

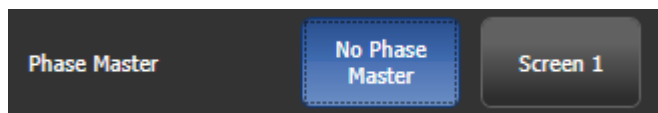

12.2.7 SPECIAL FUNCTION BANK/CLIP NUMBERS

When selecting banks and clips in the attribute editor, some bank numbers have a special function which allows you to access other screens and layers on the Ai server. This is sometimes useful to obtain other media sources such as live camera feeds without having to process them onto a new screen.

Bank 240-255 selects a Surface/Screen Fixture from 1-16

Clip 0-200 selects layer number 1-201 on that surface. Clip 255 selects the surface output (the composite of all layers)

13. RUNNING THE SHOW

So, it's showtime. This chapter describes the functions of the console which are useful when running a show.

13.1 PLAYBACK CONTROLS

13.1.1 BACK UP THE SHOW

At regular intervals while you are programming, and when you have finished programming (or you've run out of time) and it's showtime, the most important thing is to save the show (see section 3.3.5 on page 69 for instructions). It is wise to also make a separate copy of your show by saving it to a USB drive, enabling you to swap to a different console if there are problems.

13.1.2 LABEL THE CONSOLE

When you are running your show you will need to know where everything is. Use the Legend functions to set onscreen labels, or you can't beat the low tech method of marker pen and tape.

13.1.3 GRAND MASTER FADER AND ASSIGNABLE MASTERS

If the console is fitted with a Grand Master Fader, this controls the intensity of all output from the console. Normally you would set this at full, and use it if you need to quickly fade out all the lights.

The Grand Master fader is disabled by default. It can be enabled in the user settings if required.

The Pearl Expert has additional master faders: Swop and Flash masters control intensity of the swop/flash buttons; Preset master controls intensity of the preset faders; Playback master controls intensity of all playbacks.

Any playback fader on the console can be assigned to act as a master fader, which allow you to set the overall intensity of various areas of the console. Different types of master fader are available:

- Grand Master controls the intensity of all output from the console.
- Swop and Flash masters control intensity of the swop/flash buttons
- Preset master controls intensity of the preset faders
- Playback master controls intensity of all playbacks.

To assign master faders, go to System mode and select [Assign Mastering], or press <Record> then [Create Master].

By default, master faders are set to have a transparent lock, which makes the master fader remain in position even when the playback page is changed. If you don't want this to happen you can change it by pressing [Playback Options] from the root menu then press the Swop/Select button of the master.

On the Arena console, the rotary encoders on the Mini Screen are very useful as speed masters or group masters - press the encoder to select it as a master. Press the Display button below the encoders to show legends for the encoders on the screen if they are not already shown (there are 4 display modes to cycle through).



If you assign a master to a handle with an LED, the LED will flash if the fader is at zero... just as a reminder to help you work out why no lights are coming on.

13.1.4 SPEED AND SIZE MASTERS

Playbacks can be assigned to a Speed Master and/or a Size Master which allow you to control the speed and size of shapes or effects stored in a cue (or in the case of chases, to modify the speed of the chase).

There are eight possible Speed Masters and four Size Masters which allow you to separately control the parameters of different playbacks, if you need to – for example Rate Master 1 could be assigned to control position shapes, Rate Master 2 to dimmer shapes, and so on..

A playback is assigned to a Speed/Size Master by pressing [Effects] then [Speed Source] or [Size Source] in the Playback Options. The following speed sources are available:

- Free Run (default - no Speed Master. Effect runs at programmed speed)
- BPM 1-4 (override the local speed with a fixed value from the master)
- Rate 1-4 (proportionally modify the local speed using the master)
- LocalClock - the playback is set to Tap Tempo mode and all other speed settings are ignored. Using Key Profiles you can assign one of the playback buttons to [Tap Tempo] mode, and then set the effect speed by tapping the button. Effects will synchronise to the tap.

There is also a Rate Grand Master which, if used, proportionally controls the four Rate Masters (BPM Masters are not affected).

To use Speed or Size Masters you will need to assign some handles on the console to act as the Master faders. Switch the console to System mode and select [Assign Mastering]. Special key profile options are available for Speed Masters, BPM Masters default to Tap Tempo.

Speed or Size masters can have various scales, 0-100%, 0-200% and so on. A 0-200% scale would allow you to slow down and speed up the speed to double the programmed setting. Scales are set in normal (non-system) mode by selecting [Playback Options] then press the Select button of the master.

BPM MASTER OPTIONS

BPM masters can have multipliers or dividers set which allows you to vary how the tapped speed relates to the effect speed. To modify the options, press [Playback Options] at the top level menu then press the blue button of the BPM master.

Normally the BPM master fader sets the BPM, and the multiplier is shown below. Tapping the blue button will also set the BPM or you can enter BPM on the keypad and press the blue button of the master to set it.

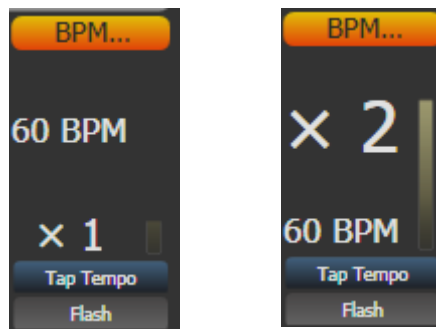

BPM master with
BPM on fader

BPM master with
multiplier on fader

The [BPM On Fader]/[Multiplier on Fader] option sets the master so that the fader now controls the multiplier and the BPM is set by tapping.

The [Multiplier Scale] option now allows you to set the range of multipliers/dividers which can be set on the fader – from $x2-/2$ to $x32-/32$.

The [Keep Multiplier On Tap]/[Reset Multiplier On Tap] option sets whether the multiplier should be reset to “x1” when a new speed is tapped.

In the Times tab of User Settings, there is an option “Compensate for Rate Grand Master” which comes into play if you have assigned a Rate Grand Master set to less than 100%. If the option is On (default), a tapped tempo will come out at the speed you tapped and will not be scaled by the Rate Grand Master. If the option is Off, when you tap a tempo, it would then be scaled down by the Rate Grand Master.

CONNECT WHEELS TO RATE/BPM MASTERS

You can adjust Rate and BPM masters from the wheels by pressing Connect followed by the blue button of the master. For a Rate master this adjusts the rate, for a BPM master you can also adjust “Edge Sync” which allows you to nudge the synchronisation forwards or backwards.

While a wheel is connected you can touch up or down in the wheel display area to nudge the value up or down. Pressing the <@> button for the wheel opens a softkey menu where you can input a numerical value or [Release] the speed and multiplier to default values.

- Using Key Profiles (see section 16.3 on page 322) you can set one of the buttons of the master to act as the “Connect” button.

13.1.5 PLAYBACK GROUPS

Playbacks can be assigned to groups. This allows you to create a set of playbacks which automatically switch off other playbacks in the same group. This can be useful when you have playbacks on executor buttons so only the most recent playback stays active, or to make life easier when busking so you don't end up with lots of playbacks fired which have superseded each other.

See section 8.3 on page 205 for details about playback groups.

13.1.6 FIXTURE GROUP MASTERS

You can assign a fader to control the master intensity of each fixture group. To do this you simply save (or move) the group button to a handle with a fader.

The blue button will then select fixtures in the group and holding the blue button gives you softkey options to filter the selection according to a pattern.

Press [Playback Options] and then the blue select button above the fader to set the fader mode to the following:

- Scale master (proportional control). Scale masters can be set to variable scales of 100%, 200%, 400%, 600% and 1000%. The higher settings allow you to increase an intensity above its recorded level.
- HTP (override level if higher than current output)
- Limit (sets hard limit)
- Take Over (place fixture and its intensity in programmer when level matched)
- Disabled (ignore fader)

If the playback fader has a display area on the screen, the level and mode of the master will be shown.

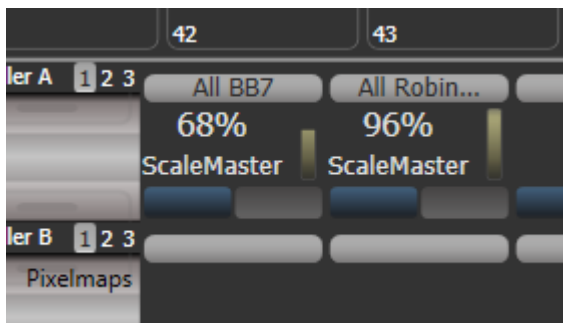

- When a group master is set to disabled or moved to a handle without a fader, it will become locked at the current fader level. Re-enable or move back to a fader to adjust the level.

Using Key Profiles (see section 16.3 on page 322), you can set different behaviour for the buttons of a group master – the blue and grey buttons if it is on a fader handle, or the touch button if it's on screen.

- Flash Fixtures – flashes the dimmer level of fixtures in the group to the level set by the group master fader, while the button is held
- Timed Flash – as above, but fade in and out using fade times set using the “Edit Times” option for the group master
- Flash Master – flashes the group master fader to full
- Timed Flash Master – as above, but fade in and out using fade times
- Swop fixtures – like Flash Fixtures, but turn off all other fixtures that aren't in the group

If a Flash Master is configured, this will also master the group flash.



You can release all masters by pressing <Release> then [Release All Masters]. This can be useful if something is being controlled by a master but you are not sure where it is.

13.1.7 SCENE MASTER

The Scene Master allows you to preset an output state by firing a number of playbacks or making live changes, using the visualiser to see the effects but without anything happening on stage. When you are ready for the new state, you fade the Scene Master fader to the other end of its travel and the new state is output.

You assign a fader to be Scene Master from the [Assign Mastering] menu in System mode. The Scene Master is set to Live mode by default which means that all changes are immediately output as usual.

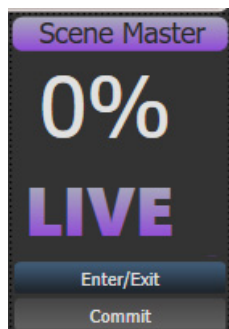

To enter preset mode, press the blue button of the Scene Master. The display above the master will show “Preset” and the background turns purple.

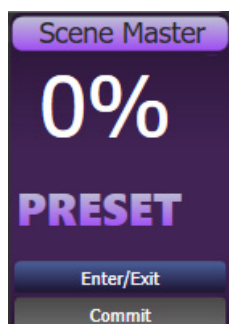

Now any changes you make – firing playbacks, stepping cue lists, applying palettes and so on – will only be shown on the visualiser. Everything you change for the preset will also turn purple on its display.

When you fade the Scene Master the state you preset will be faded to the output. If times are programmed for cues or palettes they will also run. Once the fader has reached the end of the travel, the new state is “committed” to the output, or you can press the grey button to manually commit the new state.

Normally the Scene Master will auto-reverse so you can just keep presetting new states, moving the fader alternately up and down. You can also set it to require you to move it back to zero each time. Press [Playback Options] then the Select button of the master.

The options are:

- [Auto Commit and Invert] Commits the changes once the fader has reached the end of travel. You can then preset a new state and fade the fader the other way to output it.
- [Auto Commit] You always have to fade from 0 to 100% to output the new state. The changes are committed at 100% and you then have to lower the fader to 0% to preset the next state.
- [Manual Commit] The new state does not commit at 100% and if you move the fader back to 0 the output state will go back to what it was before. You need to manually commit the changes using the grey button (the button can be changed using Key Profiles).

A Scene Master can also be set on executor buttons or touch buttons in the Playbacks workspace. In this case, hold <Avo> (or Release) and press the button to enter or exit preset mode, and press the button on its own to commit the preset to the output, You can view the state of the Master by opening the Static Playbacks workspace.

You can assign the buttons to do different things using Key Profiles – the options are Exit scene mode, Enter scene mode, Commit changes, Commit changes and exit scene mode, Enter or Exit scene mode, Enter or commit scene mode..

13.1.8 FLASH AND SWOP BUTTONS

The Flash and Swop buttons on a playback fader may be used at any time to flash and solo cues and chases. The Flash button adds the playback into the current output, the Swop button turns off all other output. . The Flash button can also be set to Timed Flash which will use the pre-programmed timings of the cue when flashing – for normal flash mode the timings are ignored.

You can reallocate the functions of the Flash and Swop/Select buttons on the console using Key Profiles – see section 16.3 on page 322. A useful alternative function is Preload which allows you to pre-position the attributes of the fixtures before you raise the playback fader, which is handy for avoiding unwanted movements (any fixtures which are already active in another playback will not change when you use Preload). You can also allocate Go and Stop buttons for cue lists and chases. To quickly change the key profile, hold <Avo> Shift and press [Edit Key Profile]. The Sapphire Touch also has a configurable Black button for each fader.

The screen relating to each playback fader shows the allocated function of the blue and grey buttons.



13.1.9 PLAYBACK PRIORITY

You can set playbacks to high priority if you do not want them to be overridden by other playbacks using the same fixtures. For example, if you have a couple of fixtures acting as a spotlight, but they are also programmed into some colour washes, you probably want the spotlight cue to take priority over the colour washes. See section 8.7.1 on page 220.

13.1.10 PRESET PLAYBACKS (TIGER TOUCH ONLY)

On the Tiger Touch, as well as the 10 playback faders across the bottom of the console, there are 10 further playbacks on the top right of the console. These are not affected by the playback page buttons and so are useful for memories you use a lot, such as par can washes, basic stage illumination or smoke machines.

You can switch to different pages for the preset playbacks using a factory-preloaded macro in two of the Macro/Executor buttons. This macro is loaded with the Personality Library, if you do not see the page macros you need to update the library.

13.1.11 LOCKING A PLAYBACK ONTO THE SAME HANDLE ON EVERY PAGE

Sometimes you might want to keep a playback accessible on a handle no matter which page you are on. The [Handle Paging] option in the [Playback Options] menu lets you do that without having to copy the playback onto multiple pages.

[Locked] ensures the playback always appears on that handle no matter what page is selected. Any other playbacks programmed on that handle on other pages will not be accessible.

[Transparent Lock] means the playback will appear on the current page only if the handle is empty on that page. If the handle is in use on the new page, then that playback will appear instead of the locked one. This can be useful if you only need the locked playback to appear on certain pages but wish to reuse the handle on other pages.

You can also lock Palettes stored on the grey handle buttons, and macros stored on the macro/executor buttons which is useful with the Macro page change buttons.

- Lock options are also available for master faders.

13.1.12 VIEWING ACTIVE PLAYBACKS

The Active Playbacks window shows details of which playbacks are active. This provides an easy way to see what is currently running.

The top line of the button shows the page number and tells you where on the desk the playback is stored. The second line shows the legend, and the third line shows which attributes are affected by the playback.

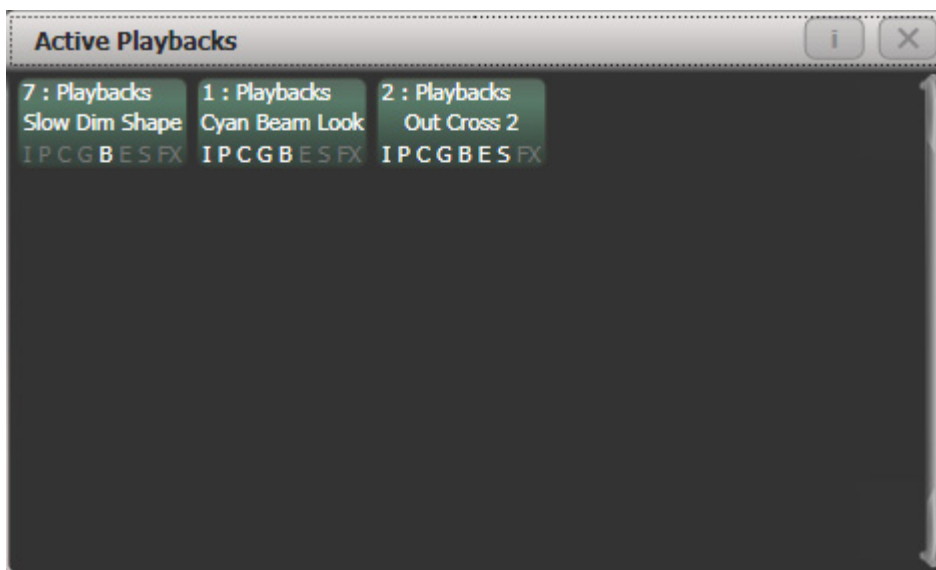

Click on a playback to instantly kill it. You can also press [Playback Options] followed by the playback in this window to change parameters of the playback.

13.1.13 BLIND MODE

If you want to program palettes or cues using the visualiser without affecting the look on the stage, you can set the console to Blind mode. Just press the <Blind> button (on consoles which don't have a dedicated button, hold down the <Avo> button and select [Blind]).

To preview a playback, you need to set the playback into Blind mode – hold the <Blind> button and press the playback select button. Repeat this to restore the playback to Live mode. You can also set Blind mode in Playback Options.

You can convert Blind output to Live output with a fade. This is useful to set up a live state in blind mode then output it without having to save to a playback. It also allows you to select multiple palettes then fade to them all at once. (Scene Master is probably an easier way of doing this however).

To convert blind to live, type a number to set fade time then press the <Blind> button.

If any attribute fade times have been set in the programmer, these will be used instead of the fade time you type.

13.1.14 BUSKING WITH PALETTES

If you have not had as much programming time as you would have liked, you might need to make up some additional effects during the show. This is sometimes called “busking”, and is where the fun starts!

You can create instant variations by recalling palette values to modify your existing cues. Palette values can have fade times saved with them, or you can set a fade at showtime for added effect.

- 1> Select some fixtures which are already in use on stage.
- 2> Type “2” (or any time, in seconds) on the numeric keypad.
- 3> Touch a Palette button to recall a palette.
- 4> The selected fixtures will change to the new palette over a time of 2 seconds.

If the palette contains programmed times, you can change the Key Profile of the palette button to set whether the programmed times will be used or not. (Press <Avo> Shift+[Key Profiles], then [Palettes] to set the key profile). Options are [Palette is fired ignoring its times] or [Palette is fired with its times]. You can also set whether the palette will take precedence over a flashed cue or not. A time entered manually as above will always override a programmed time.

When a fade time is entered on the numeric keypad, you can also change the Fixture Overlap using the [Overlap] softkey. This allows you to create “roll” or “peel” effects when using a series of fixtures. With overlap=100%, all fixtures change at the same time. If overlap=50%, the second fixture will not start its fade until the first fixture is half way (50%) through fading. The order of the fixtures is set by the order in which you selected them.

The palette fade time remains active while the Palette Fade menu is open. Press <Exit> to leave the menu and return to instant palette recall.

If you apply a palette as a “Quick Palette” (i.e. without selecting any fixtures) then it will be overridden by the next cue (so if you fade to green using a Quick Palette, then fire a cue which sets those fixtures blue, they will go blue). If you apply a palette after selecting fixtures, it will go into the programmer and override any subsequent cues until you press <Clear>.

When programming your palettes, group all the colour palettes in one area of the console, position palettes in another area, and so on. This helps you to find them when the show is running and the pressure is on.

If you are lighting a band, make position palettes for every person on stage so you can spotlight them for those unplanned solos.

You can use the Off function (see section 8.4.5 on page 212) when programming to set some cues to only affect position, and other cues to set colours, gobos, add shapes, and so on. By combining two or more cues you can produce a much wider range of effects than if all your cues set all the attributes. However, for this to work well you need to make sure you know what attribute is going to be affected by each cue; as if you fire two “colour only” cues then nothing is going to light up.

13.2 USING MULTIPLE ON-SCREEN WORKSPACES

On the screen you can configure different “workspaces” which store how the various windows are displayed. This allows you to quickly recall different setups. Workspaces are stored and recalled from the touch buttons to the left of the menu buttons, or may be stored to any grey button on the console.

You can also create a Set List which will automatically recall a workspace layout for each song.

13.2.1 VIEW MENU

Pressing <View/Open> takes you into the View menu. From here you can set up what is shown on the screen(s).

- [Window Options] allows you to reposition and resize windows.
- [Open Workspace Window] gives a list on the softkeys of all the possible windows, allowing you to open the one you need.

13.3 ORGANISING THE CONSOLE

If the layout of the fixture buttons, palettes or playbacks has become a bit mixed up during programming, you can use the Move function to move recorded items around and produce a better layout. When an item is moved, all links to other recorded items are retained.

13.3.1 USING THE MOVE FUNCTION

To move fixtures, palettes, groups and playbacks is very simple.

- 1> Press <Copy> then [Move] to select Move mode (or just press <Move> if the console has a button for it).
- 2> Press or touch the select key(s) of the item(s) to move.
- 3> Press or touch the select key of the destination.

When moving a range, it is possible to select a range containing different types of items, and there can be gaps between them. In this case, you can set [Bunch Up] mode to have all of the gaps in the range removed.

[Swap Items if Required] will attempt to reposition any existing handles which are in the way of the move. This is useful when rearranging handles on a page which is nearly full.

- If there is not enough space, (there is an item in the way or there is not enough space before the end of the page) then the action will not be completed.
- Press <Latch Menu> to keep Move mode active if you have a number of things to move around.

13.4 SET LIST WINDOW

The Set List window is a handy way of linking playback pages to songs/events in your show which you can then easily step through. You can also make notes, handy for avoiding bits of paper lying around. You can have multiple set lists in a show.

To open the Set List window, click [Open Workspace Window] then [Set List].

The Set List feature works best if you arrange your playbacks to have a page of playbacks for each song in the show.

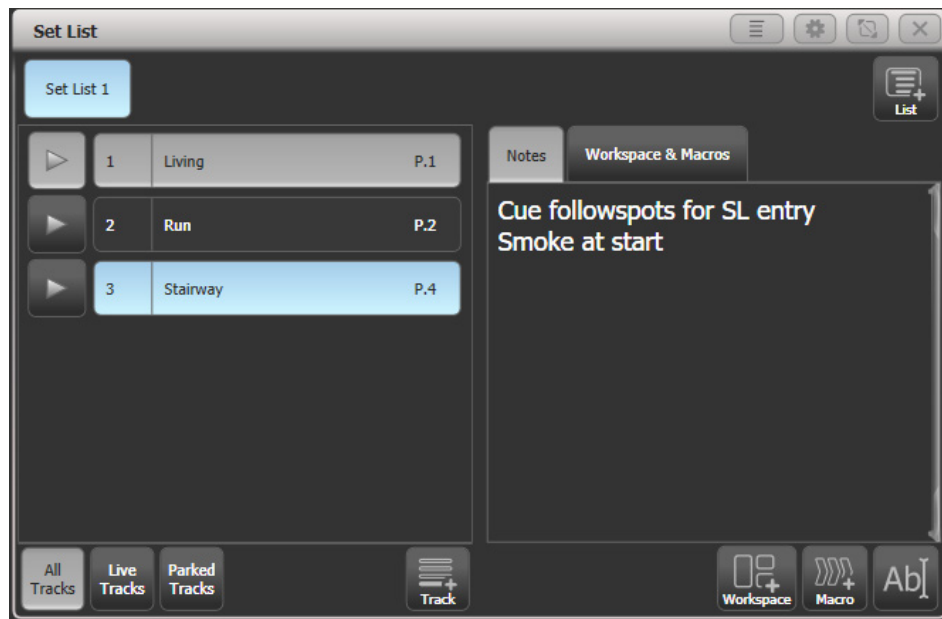

A set list is made up of tracks. When a track is added it automatically links to the current page. Pressing the play button next to the track will automatically select the correct playback page (except on Pearl Expert, because the rollers cannot be moved automatically).

13.4.1 CREATING A SET LIST

To create a Set List, click the plus button in the top right corner of the window. You can choose Empty, Pages, and Build. Pages will automatically create a set list using the legends of your existing playback pages, one page per track. Build allows you to select the pages in the order you want them. Or you can manually add a track using the plus button below the track list.

13.4.2 CONFIGURING TRACKS

Enter notes by selecting a track and clicking the text entry button, bottom right, or the Edit Note context menu button.

- You can temporarily remove a track from the set list using the Park Track context menu button.
- If you prefer to operate by using the Page+/Page- buttons, you can change the function of these buttons to step through the tracks in the set list window, using the Page Mode context menu button. When Page Mode is set to Set List, the Page+/Page- buttons are reassigned to step through tracks in the Set List, and the playback pages will automatically change as programmed in the Set List. Set Page Mode to Normal to restore normal operation. (Not available on Pearl Expert).
- You can copy, move and delete tracks using the appropriate function buttons on the console.
- You can change the legend of the Set List or of individual tracks using the [Set Legend] option.

13.4.3 TRACK WORKSPACE AND MACRO LINKS

You can trigger macros and workspace shortcuts from tracks using the [Workspace] and [Macro] buttons in the bottom right hand corner of the window.

To add a workspace link to the current track, click [Workspace], then either click a workspace shortcut or press the [Record Workspace] softkey to save the current workspace.

Macros can be added either to the whole Set List or just to the current track. Set List macros will fire every time a new track is selected, this is useful for setting the console to a preset state at the start of every song. Track macros will just fire for that individual track.

To view or edit the workspace links and macros, click the Workspace & Macros tab on the right hand half of the window. The window will then show a button for each programmed link.

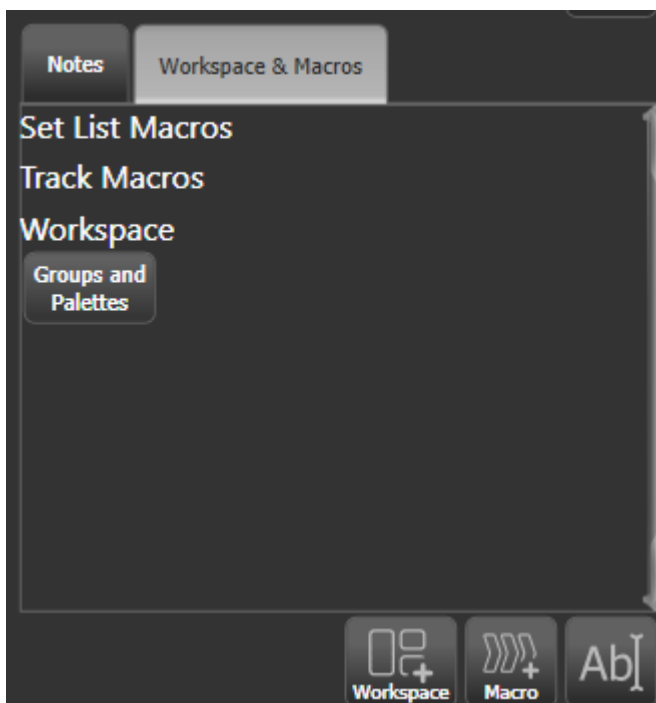

You can fire the macro or Workspace shortcut by clicking on the link button. Delete the button by pressing Delete then clicking the button, then press [Remove].

13.4.4 PLAYBACK CONTROL MACROS

Key Macros allow you to record a sequence of actions on the console then play them back (either instantaneously or as a timed sequence). This can be very useful for reducing a complex sequence of actions to a single button push. See section 3.4.1 on page 70 for more details.

Some special preset macros are available to help with controlling playbacks when used with a Set List.

[Fire First Playback] - fires the first playback on the current page.

[Fire First Playback Page 1] - fires the first playback on page 1, regardless of current page.

[Fire Playback 1] - fires the playback with user number 1.

[Kill First Playback] - kills the first playback on the current page.

[Kill First Playback Page 1] - kills the first playback on page 1, regardless of current page.

[Kill Playback 1] - kills the playback with user number 1.

[Release First Playback] - releases the first playback on the currently selected page.

[Release First Playback Page 1] - releases the first playback on page 1, regardless of current page.

[Release Playback 1] - releases the playback with user number 1.

[Release Me] - releases the associated playback (cuelist).

[Goto My Cue 1] - go to cue 1 of the associated cuelist.

13.5 EXTERNAL TRIGGERING

You can set up the console to allow most features to be triggered by external events. This is very useful in complex shows or when using in an automated setup.



Audio trigger (sound to light) requires special hardware which is not fitted on Sapphire Touch, Tiger Touch, Titan Mobile, T1 and Pearl Expert. You can plug a T2 into these consoles to provide Audio input. The line in socket on other consoles cannot be used for audio trigger.

13.5.1 CONNECTING EXTERNAL TRIGGER SOURCES

To connect a MIDI source, connect it to the MIDI in connector on the console. USB-MIDI devices supporting the DirectX MIDI driver may also be used on all consoles except T1. For the T2 this would allow you to connect a MIDI fader controller to give you real playback faders.

DMX inputs are connected to one of the DMX output connectors using a DMX male to male gender changer cable. (This is a simple plug to plug cable with all pins wired straight through, i.e. 1-1, 2-2 and 3-3). Titan Mobile may require an update of the USB Expert software to enable this function, this can be downloaded from the Avolites website.

Audio input is connected to the dedicated audio in jack (not the line in jack on the motherboard) – see information box above for consoles which provide this.

The Arena console has a switch trigger input on a jack socket.

You can link a networked PioneerDJ system to Titan to automate BPM masters; this is described in the next section. This replaces the old “Pro DJ Tap” function.

13.5.2 SETTING UP EXTERNAL TRIGGERING

Enter System mode and select [Triggers]. The Triggers window will open.

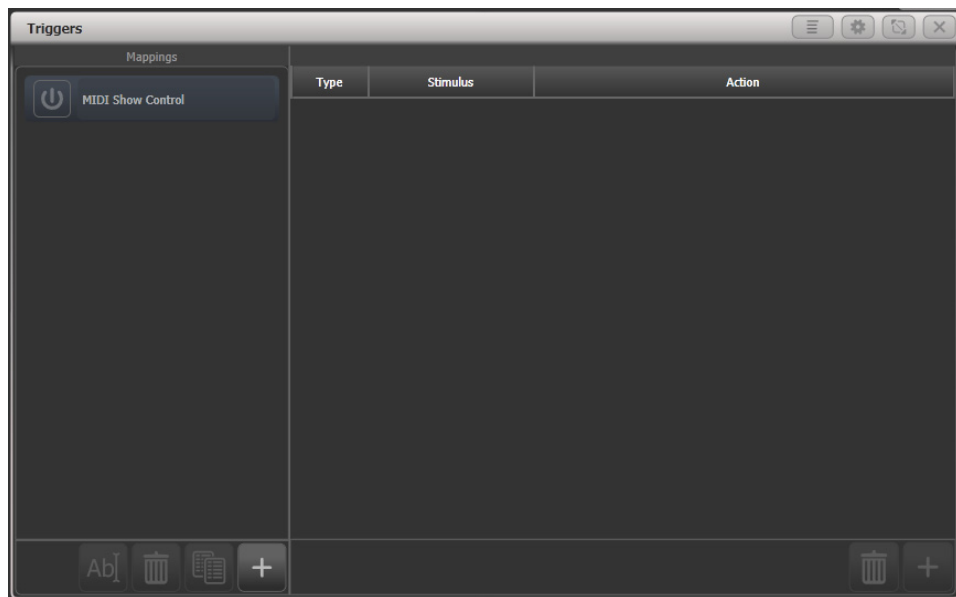

The left hand side of the window has a list of trigger sets. A default set is provided for MIDI Show control which includes standard show control messages (see next section for details).

Each set of triggers can be enabled or disabled using the “power” button at the left hand end of the mapping name.

- 1> Add a new mapping using the + button at the bottom of the left hand column, and enter a name for it.
- 2> Add a trigger to the mapping using the + button in the right hand column or softkey [Add trigger].
- 3> Select [Trigger Type] as [Hardware] or [Item].
[Hardware] triggers a physical or touch button, or fader move, and will use the key profile set for the button/fader.
[Item] triggers a programmed item, such as a cue or chase.
- 4> Press the button or move the fader to be triggered. The screen will update to show you what has been triggered. For Item triggers you can select different actions using the [Action] softkey.
- 5> Press [OK]. You have now set up the console action which is to be triggered.
- 6> Now you need to set up the external stimulus which will cause the trigger. Select [Trigger Type] as DMX, MIDI or Audio. For DMX, press [DMX Port] to select which DMX port you are using for DMX input. You will need to switch the DMX port to Rx mode using the menu option provided.
- 7> Generate the stimulus from your device (for example play the MIDI note, or turn on the DMX channel). If the [Learn] option is set to On, the console will automatically detect the stimulus. Or you can enter the details using the softkey options.
- 8> For DMX triggers you can select the address for triggering. For MIDI triggers you can select MIDI channel, MIDI Command, Value, and Level (velocity) ranges. For audio triggers the [Band] option is used to select which frequency band will cause the trigger. See section 13.5.4 for Audio.
- 9> Press [Add] to add the trigger to the list.
- 10> The window will show the trigger stimulus and the action to be carried out.

You can continue to add other triggers to the mapping.

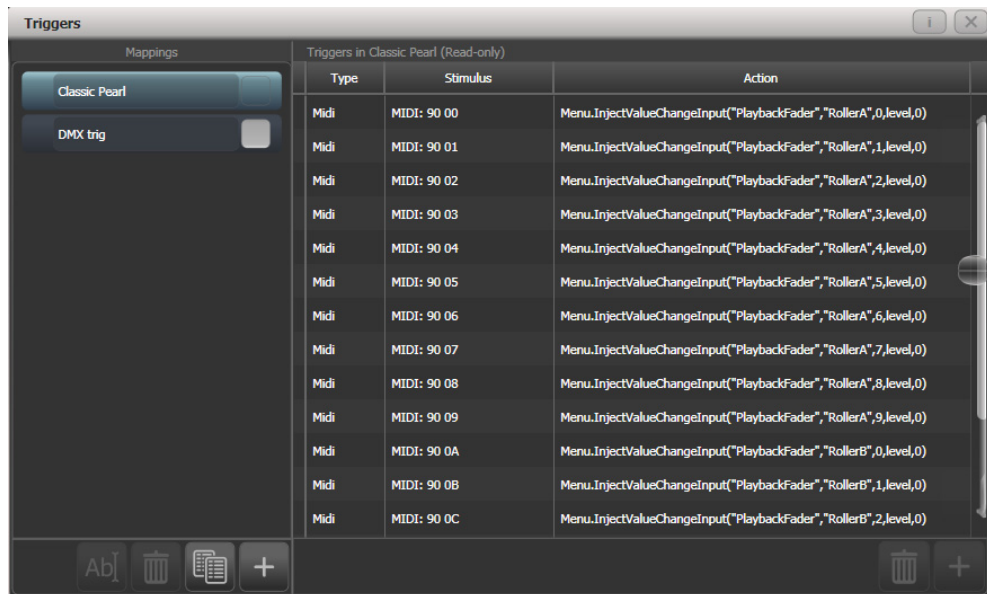

To delete a trigger from the mapping, select it in the list and press the rubbish bin button at the bottom.

To delete a complete mapping, select it and press the rubbish bin button at the bottom of the left hand column.

SETTING UP A MIDI FADER CONTROLLER WITH T2

This is how to set up a MIDI fader controller to act as playback faders on T2. Ensure your MIDI device is connected and recognised by Windows (you can use a utility such as Midi-OX to test it).

- 1> Enter System mode and select [Triggers].
- 2> Add a new mapping using the + button at the bottom of the left hand column, and call it "T2 playbacks".
- 3> Add a trigger to the mapping using the + button in the right hand column or softkey [Add trigger] – by default this is set to the correct Trigger Type of [Hardware].
- 4> Move playback fader 1 on Titan Go.
- 5> Click [OK]
- 6> Move the first fader on your MIDI controller. Titan Go should recognise the MIDI commands and display the trigger in the prompt area.
- 7> Click [Add]. The trigger for playback 1 is added to the list on the right.
- 8> Repeat from [3] to add the other 9 playback faders.

13.5.3 MIDI SHOW CONTROL

The following MIDI Show Control messages are supported:

Command	Action
GO	Fire the specified playback or cue
STOP	Pause the specified playback or cue
RESUME	Un-pause the specified playback or cue
LOAD	Set the playback level to full
ALL OFF	Release all playbacks
RESET	Same as ALL OFF
GO OFF	Same as resume

Playbacks/Cues are identified by their User Number. To set the user number, press [Set Legend] then the select button of the cue, then [User Number].

MIDI show control devices are identified by a device ID. To set Titan's device ID go to System mode and select [User Settings], then go to the [Timecode] tab. The default setting is 0.

13.5.4 AUDIO CONTROL (SOUND TO LIGHT)

On supported consoles the audio input is divided into frequency bands which can be used to provide the trigger. The [Band] option selects which of the bands is being used.

Audio triggers are adjusted in the Audio Triggers workspace.

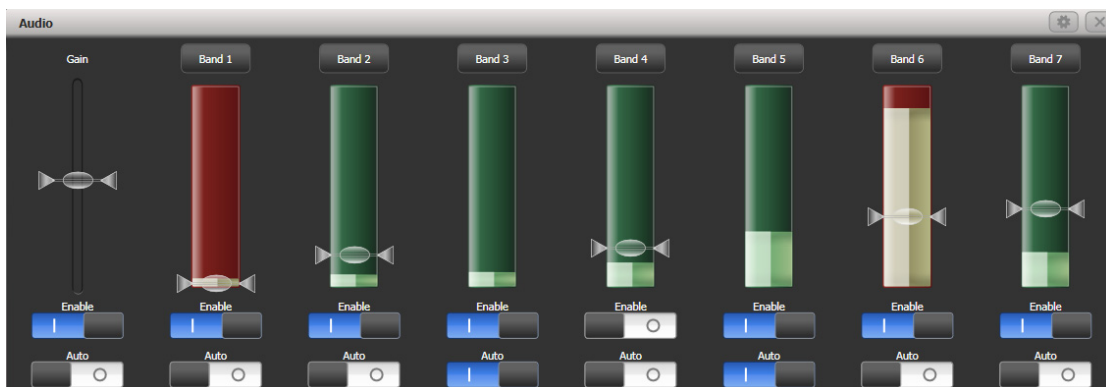

If the console does not have suitable hardware a warning message is displayed. Currently only the Quartz and Arena consoles have the audio hardware.

- The Enable switch below the gain slider disables all audio triggers
- The left hand gain slider sets the overall input gain, which can be used to boost weak signals
- Auto gain will automatically adjust the gain, this disables the slider from manual changes
- The Enable switches below each band disable triggers on that particular band
- Trigger level sets the threshold for triggering on each band. The band shows red when triggered.

- The Auto switches on the bands automatically adjust the trigger level on each band when no triggers are occurring.

You can quickly allocate a playback to a trigger by clicking the top Band button above the trigger, then select the playback to be triggered.

On the Arena console, the Audio LED (just above the power switch) will flash when audio is received. Note that the headphone socket on the Arena is linked to the motherboard audio output and can't be used for monitoring the audio trigger input.

13.6 LINKING PIONEERDJ SYSTEM TO TITAN

Using the Pioneer Pro DJ Link Bridge software you can automate BPM masters on the Titan console from a network-equipped Pioneer DJ system. You can either run the bridge software on the console itself or on an intermediate laptop.

13.6.1 CONNECTING TITAN TO THE PIONEER SYSTEM

You need to get the console and the Pioneer equipment connected to the same network. The Pioneer equipment has some limitations with its network IP address - it either needs to be assigned an address using DHCP or it uses an automatic address in the range 169.254.*.* - which means that if you are already using networking to control the lights (ArtNet or sACN) things can get a bit complicated as many lighting products cannot use that address range.

PIONEER BRIDGE RUNNING ON THE CONSOLE

If you aren't using networking, or your console has two network interfaces, or you can adjust your lighting to a suitable address range, then you can run the Pioneer Bridge software on the console itself. If your console includes an ethernet switch, you can connect the "Extension" ethernet socket on the Pioneer equipment directly to the console, otherwise you need to go through an external switch.

Run the Pro DJ Link Bridge software from the Tools → Additional Programs menu on the console.

- You can set the Bridge software to run automatically when the console powers up using the Tools → Control Panel → Run on Startup menu option. This is

useful in club environments where the console is always linked.

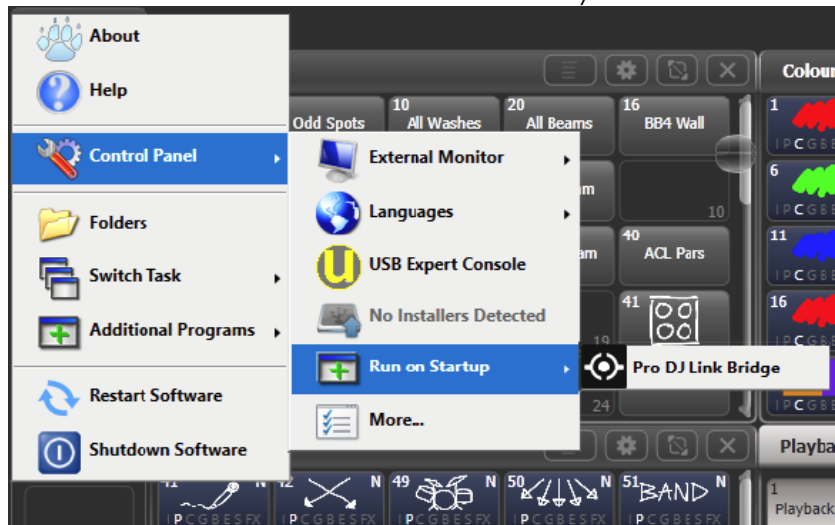

Look at the Interface tab of the bridge software to see what IP address is being used by the Pioneer equipment. You need to set the network interface on the console to use an IP address in the same range – if it is using DHCP, just set the console to DHCP as well, or if using the automatic addresses set a fixed address. For example if the bridge is set to 169.254.225.212 as in the image below, set the console to 169.254.225.1 (assuming nothing else on the network is using that address).

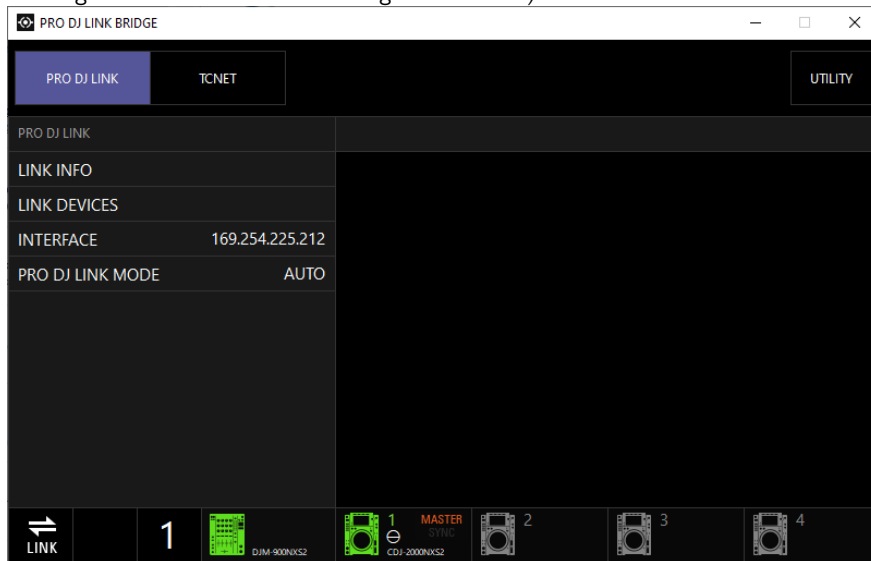

- Once you have everything connected up and have got all the IP addresses right, the bridge software should show connections for both the Titan console and the DJ mixer.
- Some ArtNet / sACN equipment can be configured to run on the 169.254.*.* address range, in which case you can run everything on the same network.

PIONEER BRIDGE RUNNING ON SEPARATE COMPUTER

If you need to keep the Pioneer network separate to the lighting network and your console only has a single network port, or if you just prefer to have the bridge separate

from the console, then you can download the bridge software from the Pioneer website and run it on a separate computer.

If you need two separate address ranges then your computer will need two network interfaces.

Once you have everything connected up and have got all the IP addresses right, the bridge software should show connections for both the Titan console and the DJ mixer.

13.6.2 PIONEER WORKSPACE WINDOW

From the [Open Workspace Window] menu, select the [PioneerDJ] option.

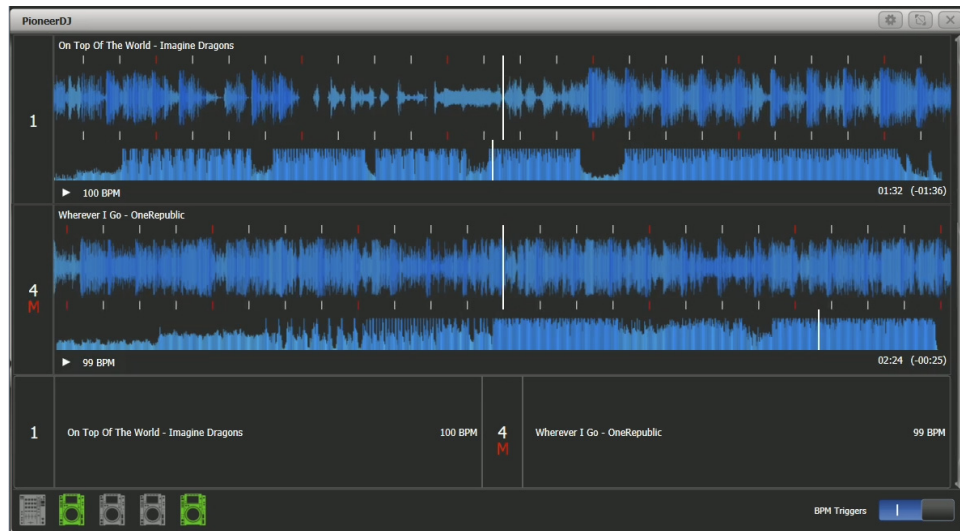

The top of the window shows a big (detail) waveform and a small (full track) waveform for the current track. Multiple tracks can be shown one above the other.

Below that, details of the current track playing on each device is shown.

At the bottom, the connection status of the Pioneer equipment is shown. – green when connected.

You can select which track is currently the Master by pressing the track number on the left or in the detail area at the bottom. A red “M” shows which track is the master. If you assign your trigger as “Master” this lets you quickly change which track is controlling the BPM.

Context menu buttons allow you to show or hide the big and small waveform displays, the track details and the status bar. The other elements of the window will change to fill the space.

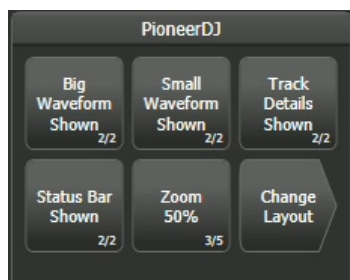

The [Zoom] button allows you to set the scale of the big waveform.

The [Change Layout] button allows you to select the view in the workspace. This is useful if you want a smaller window:

[Full] – shows all the currently playing tracks

[Master] – shows only the waveform of the master track

[Condensed] - shows details of all the tracks at the bottom, but only shows the waveform of the master track. You can change the master track by pressing the track number in the Track Details area.

13.6.3 SETTING UP BPM TRIGGERS FROM PIONEER

You will need a fader on the console configured as a BPM master which will be automatically controlled by the track BPM playing on the Pioneer devices. See section 13.1.4 on page 284 for how to set up a BPM master.

Enter System mode and select [Triggers]. The Triggers window will open.

- 1> Add a new mapping using the + button at the bottom of the left hand column, and enter a name such as "Pioneer".
- 2> Add a trigger to the mapping using the + button in the right hand column or softkey [Add trigger].
- 3> Select [Trigger Type] as [Item].
- 4> Press the button for the BPM master you want to control.
- 5> The [Action] button will show [PioneerDJ] as this is currently the only action for a BPM master. Press [OK]. You have now set up the console action which is to be triggered.
- 6> Now you need to select which Pioneer deck will control the BPM. Select [Deck=] as Master, 1, 2, 3, 4. [Master] will use the track you have currently selected as Master (red M displayed). The 1-4 options let you fix the control to one of the decks.
- 7> Press [Add]. The trigger should now appear as shown below.

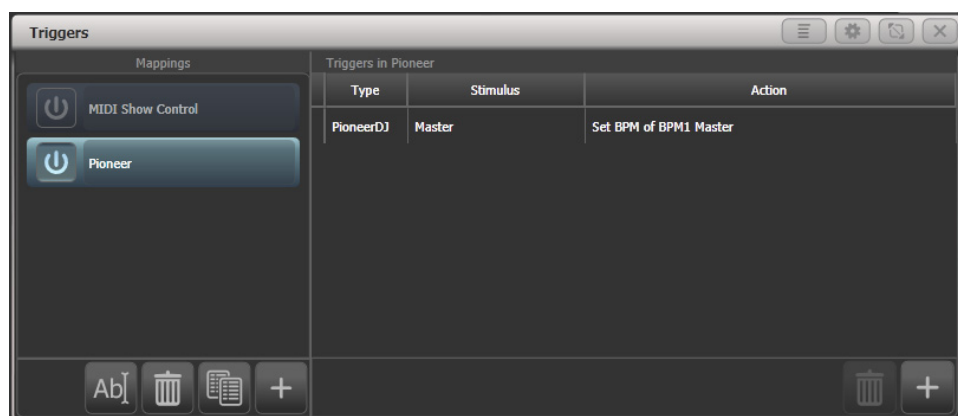

Now you should see the BPM master automatically change to match the BPM of the track playing which you have selected as Master (or on the selected CDJ player if you selected a fixed player number).

- To regain local control of the BPM master, switch off the "BPM triggers" switch at the bottom of the PioneerDJ workspace window.

13.7 LINKING CONSOLES FOR MULTI-USER OR BACKUP

On large shows it is sometimes necessary to have multiple operators programming or running different aspects of the show. The Titan system allows a number of consoles to be connected together to give an integrated system with multiple control surfaces.

In addition, on many shows it is important to have a backup console running in case the main console fails during the show. Titan allows you to run a second console over the network which it keeps synchronised with the main console. Should the worst happen, a single keypress can transfer control to the backup console.



Linked consoles must be running the same version of Titan. If using PC Suite (Titan Mobile, Titan Go or Simulator) you may need to disable any firewalls on the PC.

13.7.1 SETTING UP CONSOLES FOR MULTI-USER

Titan consoles may be connected to each other for collaborative programming or show operation. Multi-user operation is described in detail in section 3.5 on page 73.

13.7.2 SETTING UP CONSOLES FOR BACKUP

Any Titan console can act as backup for any other console, they do not have to be the same model. For example you could run Titan Mobile as backup. You can also in an emergency use the screen on a TNP to operate.

However do plan ahead and think about what parts of your show will become inaccessible if the backup device has less faders/handles than the main console.

- 1> *Connect both consoles to the same network and ensure they are set to the same IP range (see section 18 on page 345).*
- 2> *Press Disk, [TitanNet Sessions], [Backup].*
- 3> *Consoles available for backup will be listed in the softkeys.*
- 4> *Selecting a console will place that console into backup mode and sync the show to it.*
- 5> *The backup console will show a display indicating the backup status and show name.*

In backup mode the backup console screen displays the current connection and sync status including current show name.

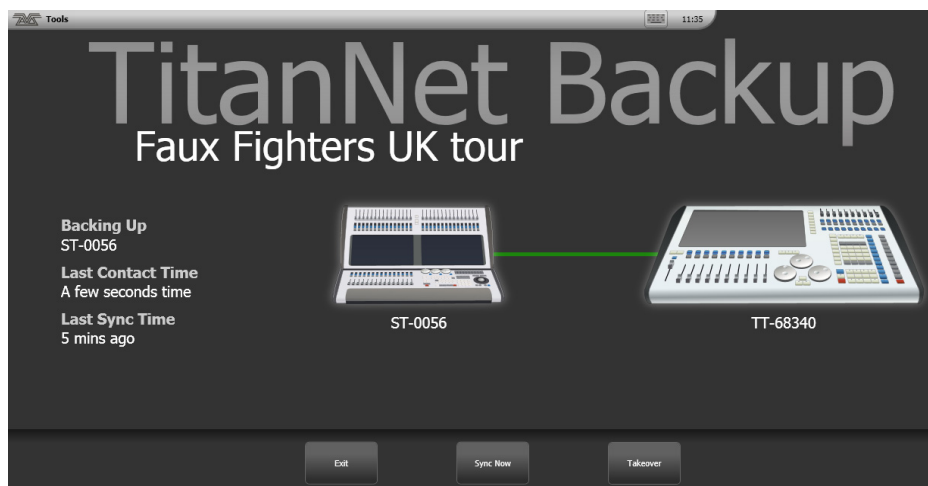

A green line between consoles represents a good connection. If a red line is shown there is a problem with the network connection. A blue line will appear during sync operations.

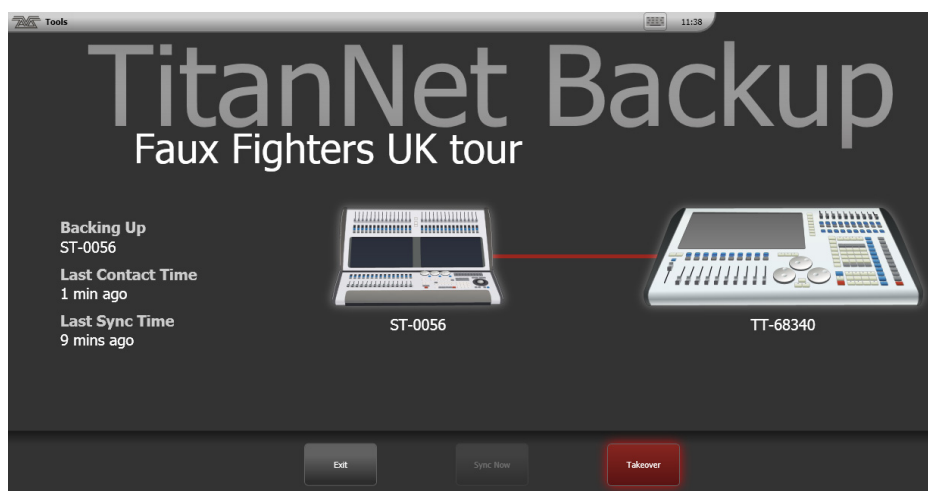

- Shows will automatically sync whenever a show is saved on the main console (including autosave). You can also choose to sync at any time by selecting [Sync Now].
- Pressing [Exit] will abort backup.
- [Takeover] will enable control on the backup console and disable DMX output on the main console. A prompt will appear on the main console to warn that DMX has been disabled. On touch consoles touching on this prompt will open the '<Exit> Safe Mode' menu with a softkey option to re-enable output. On the Pearl Expert you can re-enable DMX output via the shift (<Avo>) menu.

14. REMOTE CONTROL

With the addition of an external Wireless Access Point, the console can be remote controlled using Wi-Fi from an Android or iOS mobile device such as a smartphone or tablet. This can be invaluable when rigging, testing and focusing. You can also run and store playbacks and palettes from the remote.

You can connect multiple remotes to the console and the console itself remains functional while the remote is connected. Each remote has a separate programmer so an operator can continue to work on the console while another user programs other cues or palettes on the remote.



The remote function operates using the Avolites Remote app on the mobile device. This can be downloaded from the Google Play store or Apple App Store..

Make sure you install the correct version of the app to match the console software version, there are different apps for each version.

14.1 SETTING UP THE REMOTE

All you need to do is make sure that the console is on the same network as your mobile device. The app will automatically detect all the consoles on the network.



Ensure that Wifi security is enabled on the network you are using, as anyone who can connect to the wifi and has the app will be able to control the console. You don't want someone in the audience taking over the show.

- You may experience problems with the remote if you have an internet router on the network, as this may route show traffic to the internet rather than between the remote and the console. If the remote does not work properly, disconnect your router from the network.

14.1.1 USING AN EXISTING NETWORK

If you are connecting to an existing network, DHCP will probably be enabled which will automatically set suitable IP addresses on the console and mobile device. All you should need to do is to plug the console's Ethernet connection into the network.

If the console is set to have a fixed IP address you will need to manually set a suitable IP address for the network – consult the person who manages the network.

14.1.2 NETWORK SETUP USING A DEDICATED ACCESS POINT

This is a basic setup assuming that the console is connected directly to an access point. For information on setting up your Wireless Access Point please refer to the documentation provided with it.

- We advise using a proper wireless access point rather than a wireless router (ADSL router). Although routers are cheaper, the WiFi connection through to the Ethernet can be flaky. Some routers can be switched to an “access point” mode to avoid this problem.

You need to set up the network settings on the Wireless Access Point, the mobile device and the console so that they can communicate with each other. In this example we use an Android smartphone but other devices are similar.

- 1> In the access point's admin screen, give the access point an IP address such as 10.0.0.1, make sure wireless is switched on and enable the DHCP server. Take note of the name of the wireless network (SSID).
- 2> Connect an Ethernet cable from the back of the console to the access point.
- 3> Set the IP address of the console: Switch to System, select [Network Settings], press [Local Area Connection], then press [Set IP 10.*.*.*].
- 4> On the mobile device, go to WiFi settings or Network Settings and ensure Wi-Fi is set to on.
- 5> Select the wireless network from the list, the name you took note of earlier. The mobile device should automatically get an IP address from the access point.
- 6> Run the Titan Remote app. You should see the console listed.



If you are using the remote at showtime, on the Access Point you should select the option to hide the SSID. If you do not do this, every smartphone in the audience will find your wifi and try to connect to your Access Point which will make the remote operation very sluggish.

14.2 OPERATING THE REMOTE

To connect to the console, open the Titan Remote app and a list of available consoles will be shown - hopefully if you have done the network setup correctly, you will see your console listed.

There is also a local emulator which can be used to test or demonstrate the remote when no real console is connected.

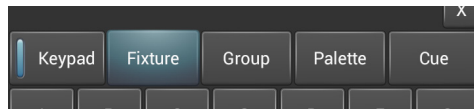

Choose what you want to control using the row of buttons across the middle of the app. The Keypad button enables or disables the numeric pad (the keypad overlays all the other screens, so you will need to turn it off to see the others).

14.2.1 KEYPAD

The keypad screen lets you do most common tasks in the way a programmer's remote normally works. You can turn on/Locate fixtures and dimmers either singly or together.

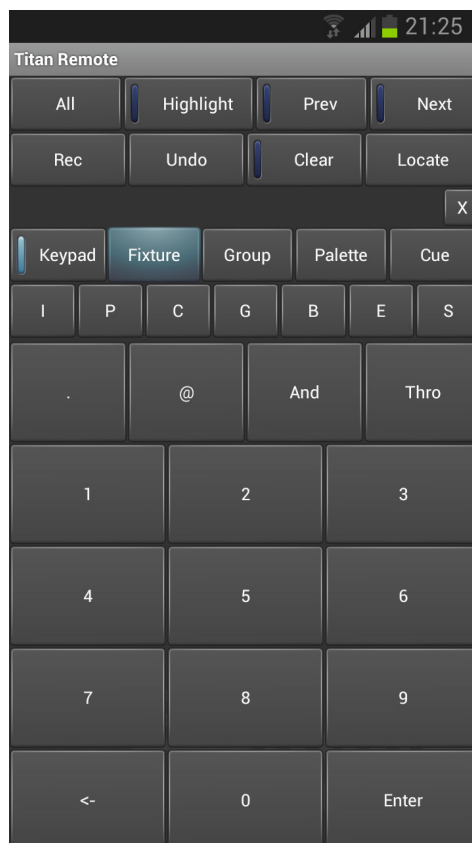

The User Number of the fixture or dimmer is used for control. For example to turn on dimmer 3 at 50% you would press:

`3@5`

To turn on dimmers 1-10 at 80% you would press:

`1 Thro 10 @ 8`

For 100% you just press @ twice, for example

1 Thro 10 @ @

To locate one or more fixtures, press Locate instead of the @ button. You can select multiple ranges of dimmers or fixtures using the And button, for example *1 Thro 10 And 20 Thro 30 @ 6*.

14.2.2 CONTROLLING FIXTURES

The fixture screen allows you to select fixtures exactly as you would on the console.



You can then use the Palette screens to control the fixtures, or press the IPCGBES buttons to directly control functions of the fixtures using wheels.

You can scroll the fixture screen up and down by dragging the window. To view the fixture pages, drag the Pages bar to the right.

Press the All button to select all fixtures. Hold down the All button to step through various selection patterns (odd, even etc).

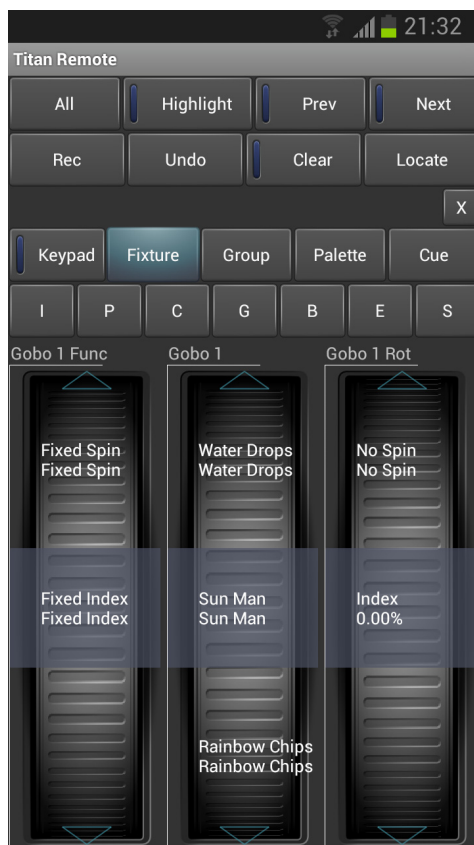

The wheels show function values (such as colours or gobo names). To go to the next function, just touch the arrows at the top or bottom of the wheel. To manually scroll the value, spin the wheel with your fingers. If there are more than three functions, touch the IPCGBES button again to change to the other functions.

Press the Clear button to clear the selection and all changes in the remote programmer. Hold down the clear button to clear all programmers (for example if someone has been doing something on the console at the same time, this will clear the console's programmer too).

You can also play back cues using the Cue screen. Hold down a playback button to kill or release an active playback.



If you update the legends of palettes or cues on the console while the remote is running, the legends on the remote will not be updated. <Exit> and restart the remote app to show legend changes made on the console.

14.2.3 RECORDING GROUPS AND PALETTES

You can record groups and palettes using the Rec button on the remote, then click a workspace button as normal. You can also hold down an empty button to quick record a group or palette.

If you hold down a used palette button, the current programmer will be quick merged into the existing palette.

You cannot record cues using the remote.

15. TITAN NET PROCESSOR OPERATION

A TNP (TitanNet Processor) unit can operate either as a slave unit, producing additional DMX lines for a console, or as a simple console for stand-alone operation. In console mode you can prepare a show on a full console, then load it into a TNP for operation, using power-on playbacks (See section 8.2.10 on page 204), or you can connect an external touchscreen to the TNP and operate it using the Titan Go interface screen.

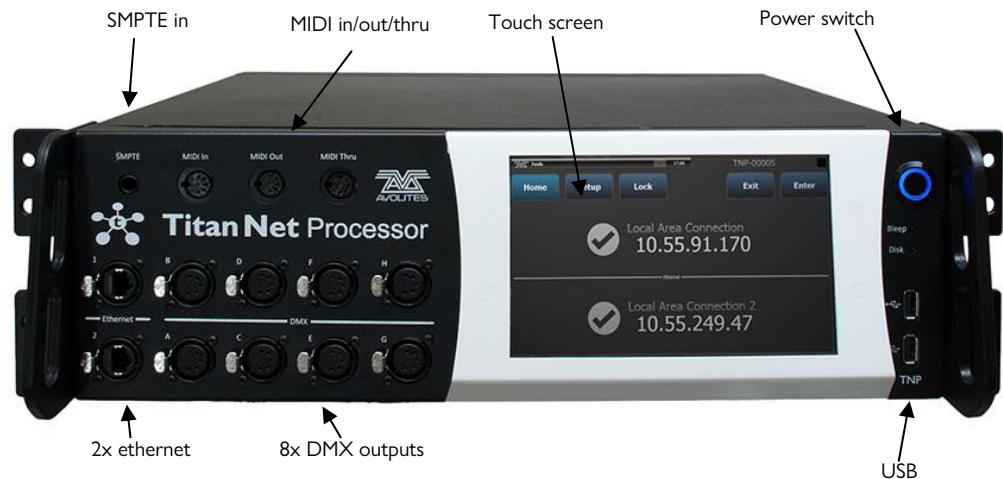

Select the operation mode from the toolbar at the top of the screen, using the Switch Software Versions option.

TNP = slave mode

Console = console mode

15.1 TNP SLAVE MODE

Normally the TNP screen shows the “Home screen” which displays the connection status and IP address of the two Ethernet ports on the device. Buttons across the top allow you to configure the device. The <Exit> button always takes you back to the previous menu.

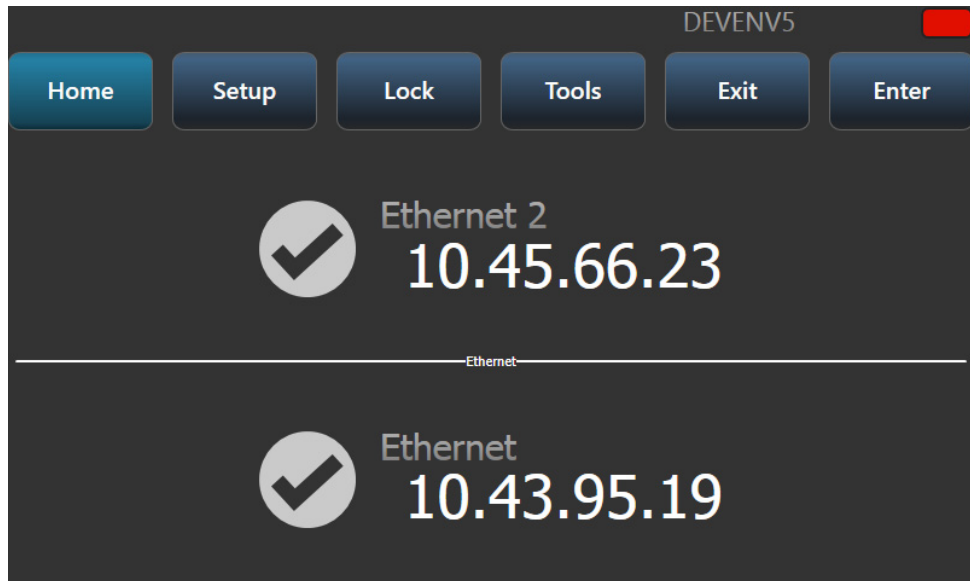

15.1.1 SETUP

The setup screen allows you to configure network port settings, and node settings for the overall device by touching "Network Settings" or "Node Settings".

For **Network Settings** you first select which Ethernet port you want to configure

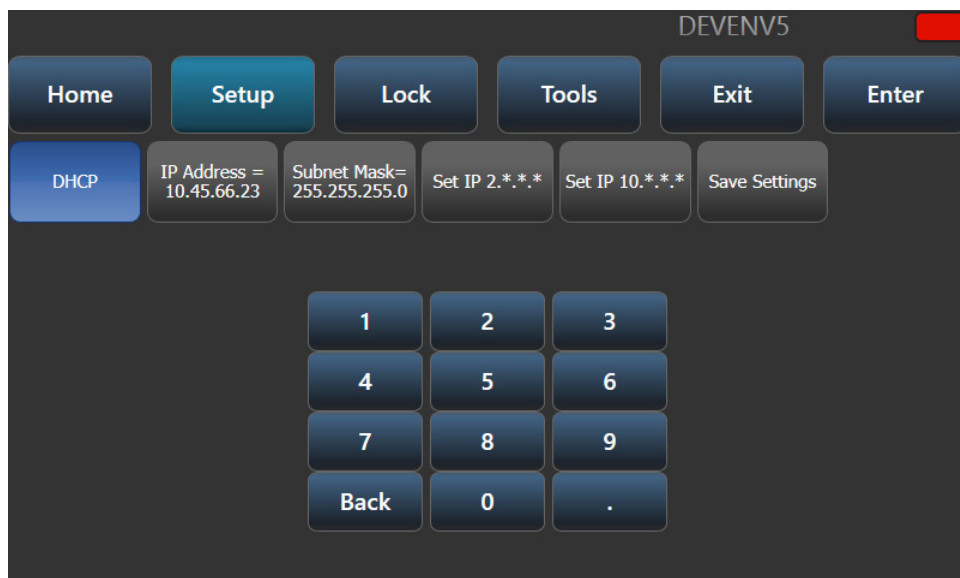
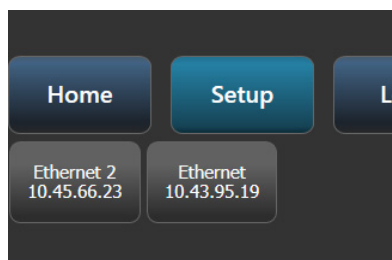

You can then enable or disable DHCP, set IP address and Subnet mask using the number buttons, or set a fixed (automatically generated) 2.*.* or 10.*.* IP address.

Touch the "Save Settings" button to store your changes.

For **Node Settings** you can change the legend of the device and the line colour. This is shown on the top line of the device and on all TitanNet pages on connected devices. It helps you identify the device when you use the TitanNet overview on the console.

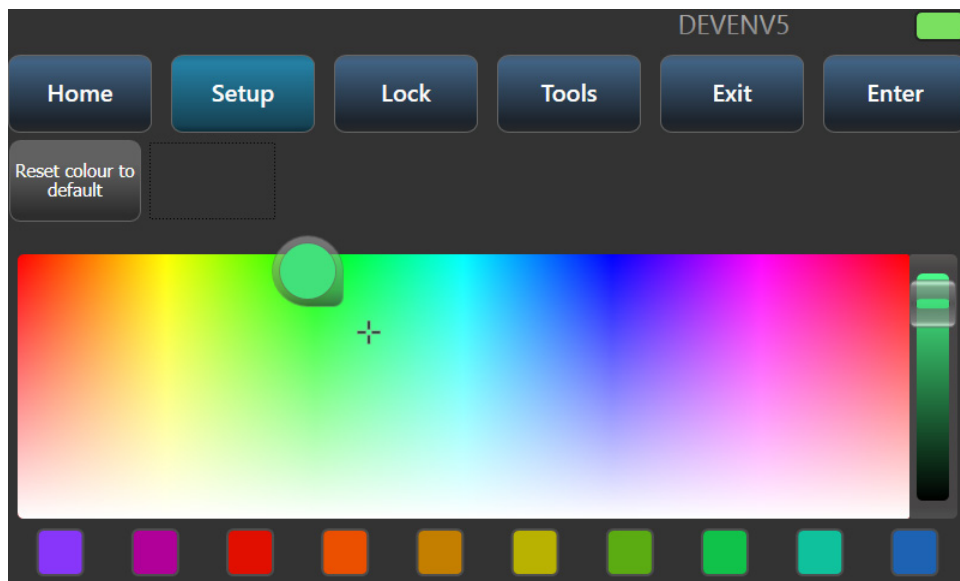

15.1.2 LOCKING THE TNP

The Lock screen displays a keypad and asks you to enter a lock code. When the device is locked, the screen shows “Locked” and shows a keypad to unlock.

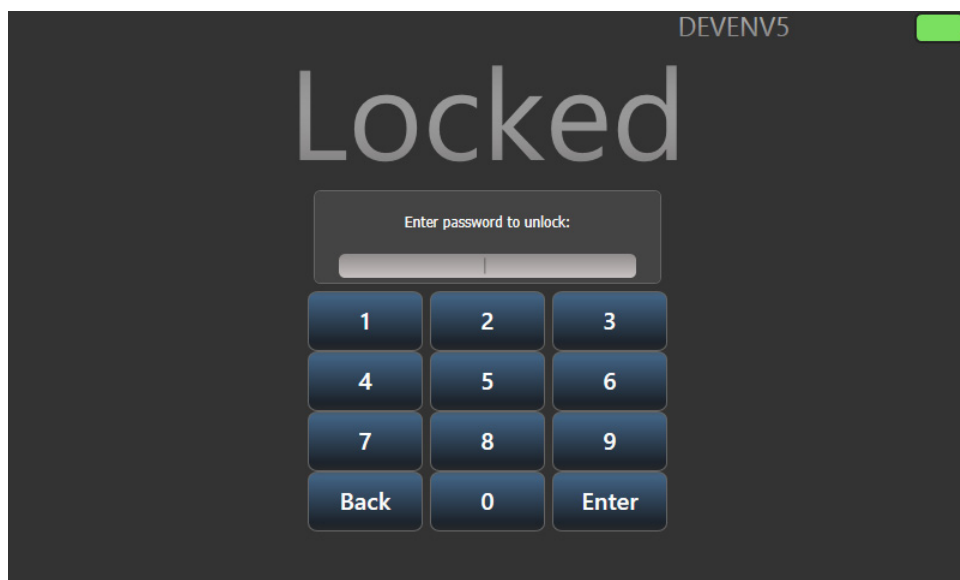

15.1.3 TOOLS

Currently there is only one option on the Tools screen, “Monitor”. This allows you to monitor the processing load of the device. You can select to monitor either cycle time or render time.

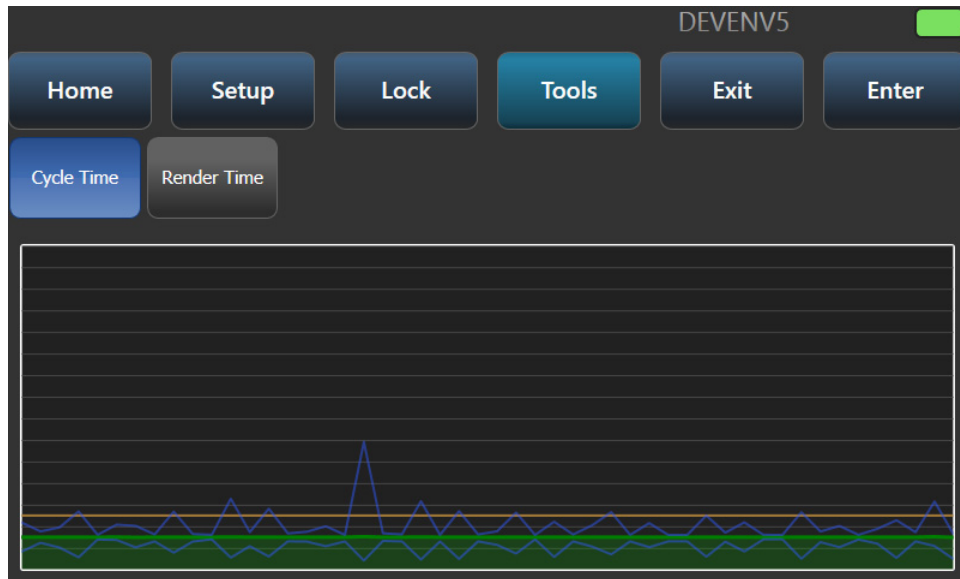

15.2 TNP CONSOLE MODE

TNP console mode allows you to use a TNP to run an unattended show, or to act as an emergency backup. You can create a show on a full console then load it into the TNP for operation, or you can connect a console in multi-user mode to create programming on the TNP itself.

15.2.1 RUNNING PLAYBACKS

Use the View command (see next section) to select Playbacks Grid mode.

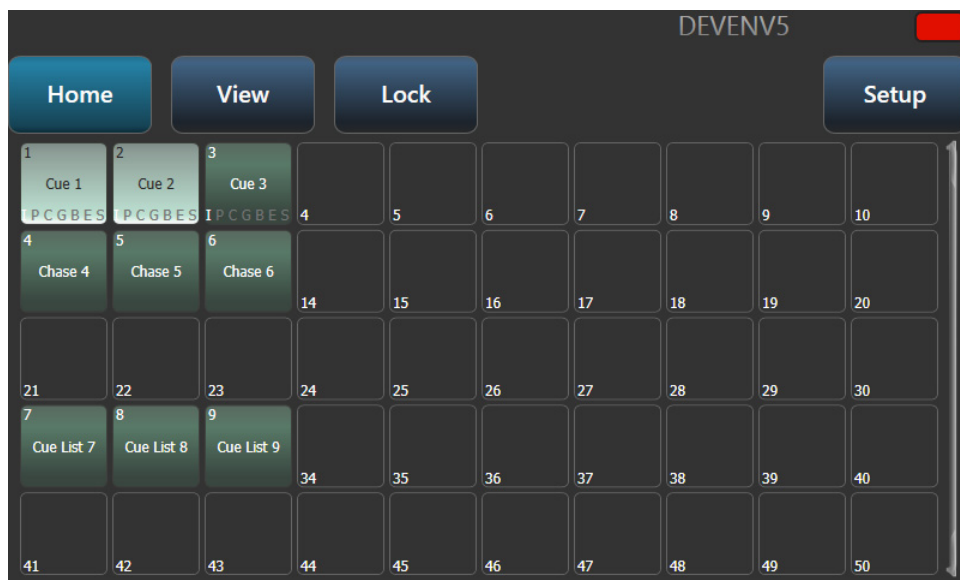

You can then run playbacks from the standard Titan playbacks window by touching the buttons.

15.2.2 SETTING THE VIEW

In Console mode, the Home screen can be set using the View button to display either Network Adapters (like in slave mode), Playbacks Grid or Session View.

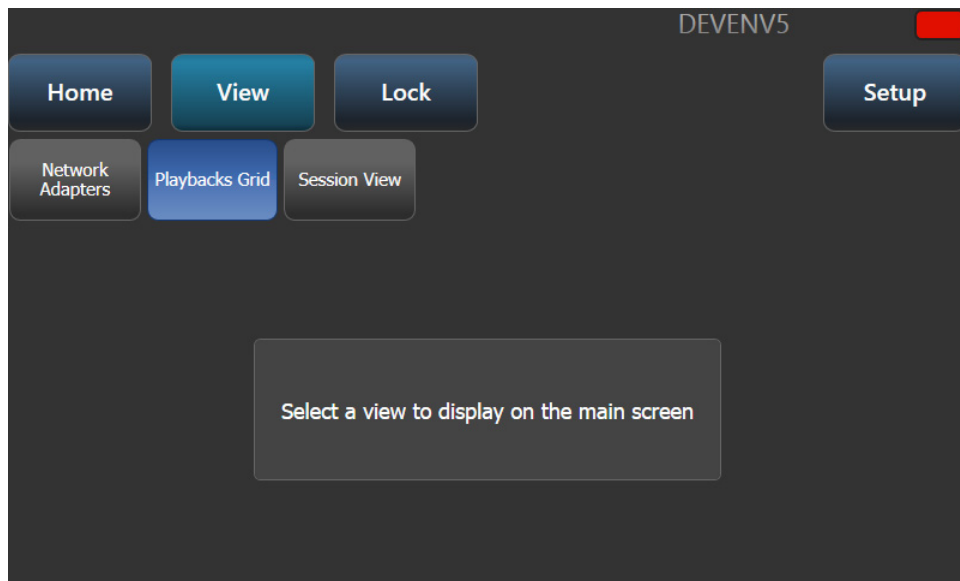

Session view shows how the TNP unit is connected to other Titan devices on the network.

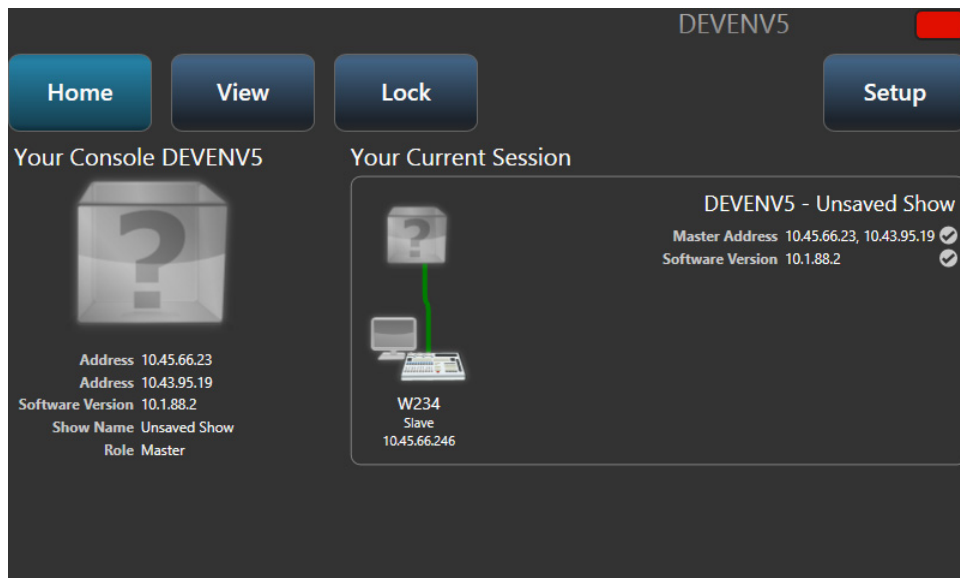

15.2.3 LOCKING THE PANEL

The selected view will also be shown when the console is locked using the Lock button. If the playbacks screen is shown, the only action available is to fire and kill the playbacks on the screen. Touch the Show Keypad button to display the numeric keypad for unlocking.

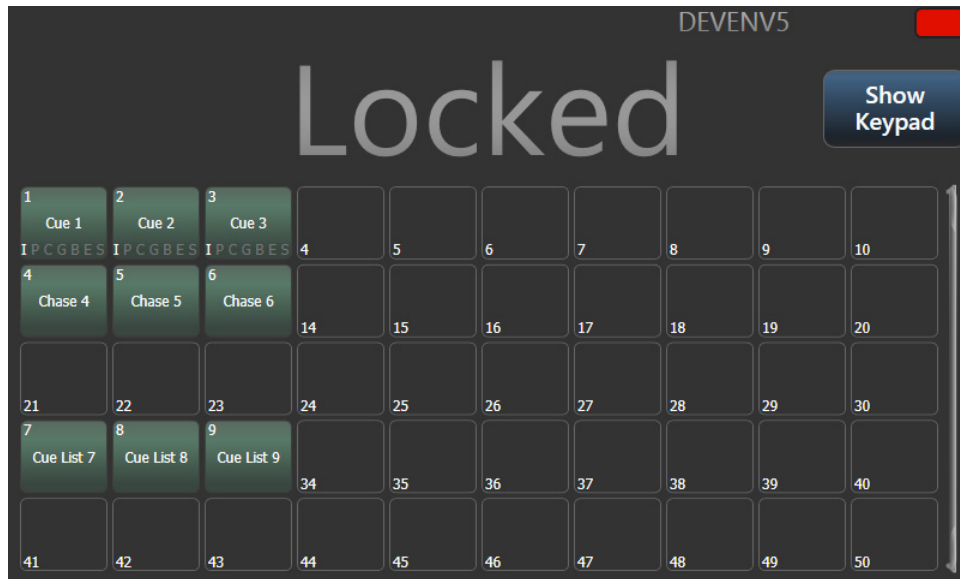

15.2.4 LOADING AND SAVING SHOWS, AND OTHER SETUP

Setup mode allows you to load and save Titan shows. You can also change Network Settings, Node Settings and set Monitor mode (see Slave mode above for details).

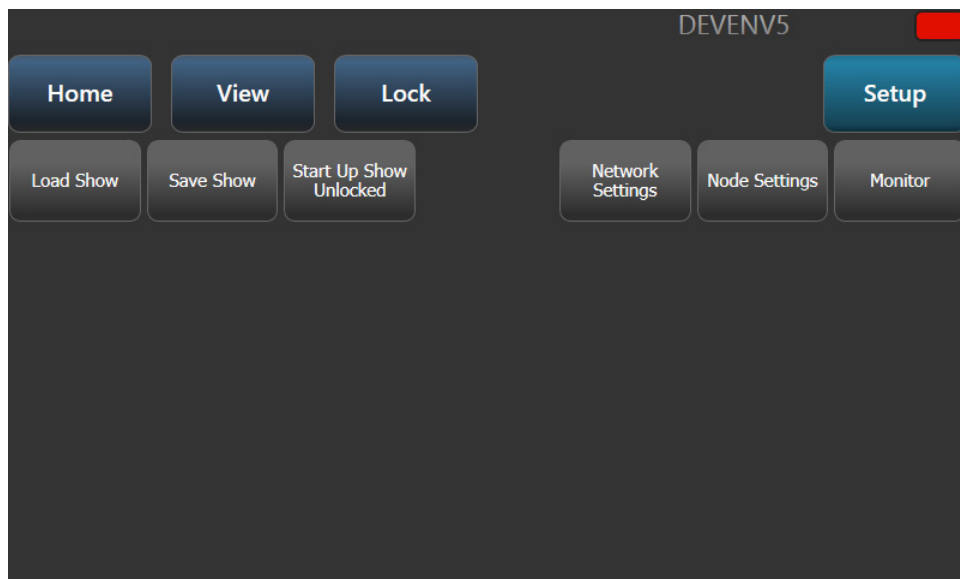

Load show presents the standard Titan loading screen. See section 3.8 on page 79 for details.

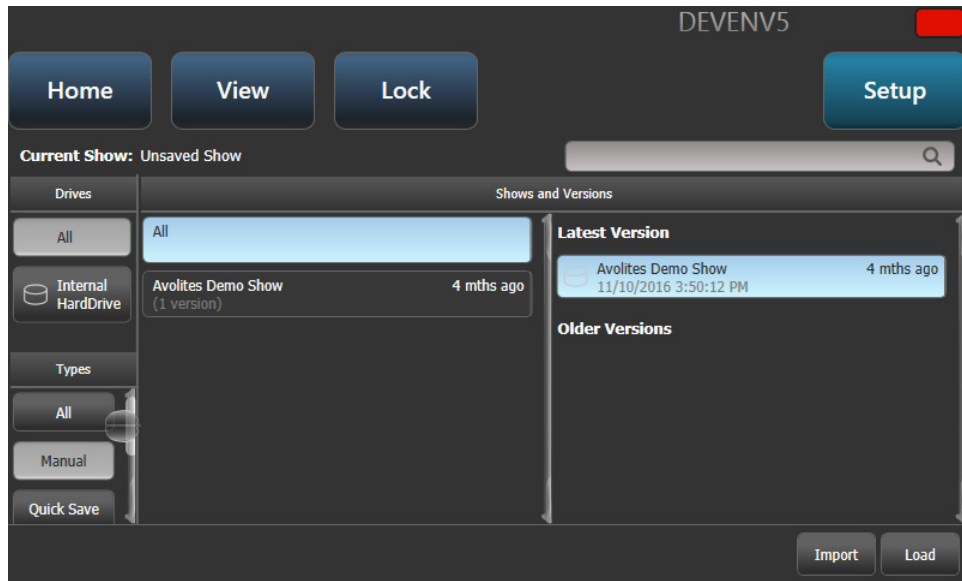

Save Show allows you to save a show which you have modified on the TNP using a remote console.

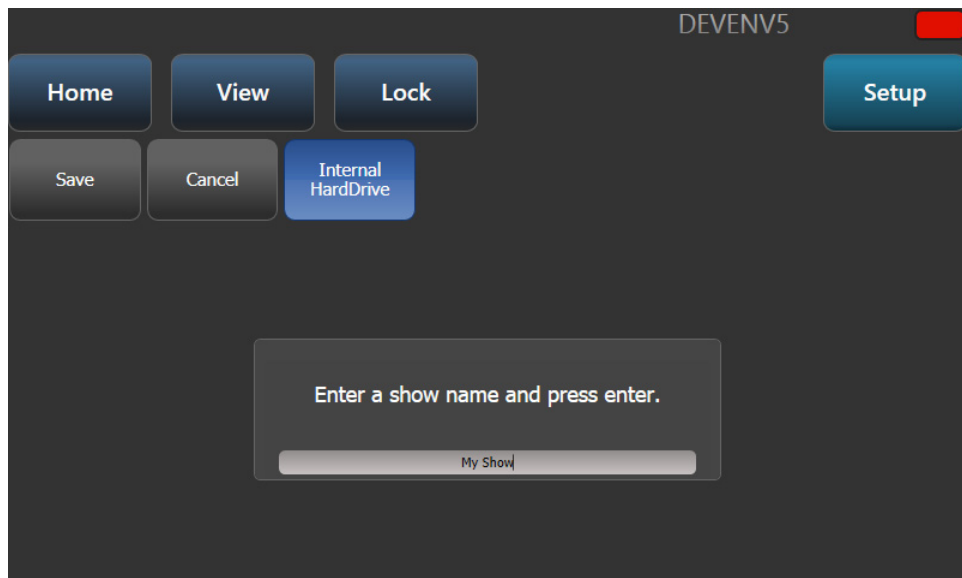

16. SYSTEM MENU AND USER SETTINGS

The console has a large number of options to help you set it up just the way you like it. Commonly used options can be set from the User Settings menu which is available on a softkey when you hold down the <Avo> button.

In this chapter there is also information on how to upgrade the application software.

16.1 THE SYSTEM MENU

The System menu is accessed by holding <Avo> and pressing Disk. Some consoles are also fitted with a key switch or mode switch to select System mode.

The options in this menu are separated from the other options on the console because you would normally only change them occasionally, or because they can have serious effects on the way the console works and you wouldn't want to change them accidentally.



When the console is in System mode, playback control, preset controls and programming buttons are all disabled.

16.1.1 NETWORK SETTINGS

This option sets up networking (Ethernet) parameters for the console. See section 18 for details.

16.1.2 DMX SETTINGS

Allows you to configure how the console outputs DMX. This option is described in detail in the next section 16.5.

16.1.3 DMX MERGE SETTINGS

Allows you to select how DMX will be output across multiple consoles or processing nodes. See section 16.5.4.

16.1.4 SYNERGY SETTINGS

Sets up the Synergy software for linking to an Ai server, see section 12.1.3.

16.1.5 TITANNET SECURITY

This option sets how the console communicates with other Titan devices as a backup console. See section 13.7 for information about backup.

16.1.6 USER SETTINGS

The User Settings menu may also be accessed from Program mode: hold down the <Avo> Shift button and press [User Settings]. See section 16.4.

16.1.7 KEY PROFILES

Allows you to modify the functions of some buttons. See section 16.3.

16.1.8 WIPE

The Wipe menu erases the current show. This is the same as the [New Show] option on the Disk menu, but is provided here for old fashioned Avolites users who are used to it being on the System menu.

The [Wipe Visualiser Patch] option will erase all fixtures from the visualiser without affecting the current show.

16.1.9 TRIGGERS

Sets up the console for external triggering such as MIDI or DMX-in. This option is described in detail in section 13.5 on page 295.

16.1.10 ASSIGN MASTERS

This option allows you to assign any playback fader to be a master fader. Various different types of master fader may be assigned. See section Grand Master fader and assignable masters on page 283 for more information.

16.1.11 CONSOLE LEGEND

Lets you set the legend of the console, this is displayed in networking screens when you are linking the console to others.

16.1.12 TITAN TELEMETRY

To help Avolites with software development and bug fixing, the console will report anonymous information to Avolites. This includes details about faults that occur, statistics on how long certain functions take, and usage of functions. This information is really useful for improving the software, however if you would prefer to disable it, click the [Telemetry Enabled] button to switch it to [Telemetry Disabled]. Telemetry information will only be sent in any case if the console is connected to the internet.

16.1.13 DISPLAY SETUP

This option gives you a menu for enabling and disabling external monitor(s). If you don't have a monitor connected, set this option to "Disabled" to improve the performance of the console.

16.2 EXTERNAL DISPLAYS

For extra workspace you can connect another display to the DVI port(s) on the console (VGA on Pearl Expert and Tiger Touch mk1). The Sapphire Touch can have two external displays, all other consoles can have one. You can use touch screens, we advise using Windows Touch compatible monitors to avoid driver issues.

Obviously for Titan Mobile and Titan Go you can connect whatever external displays your computer will support.

An external display is disabled by default and will show a 'disabled' message. To enable, switch to System mode and select [Display Setup] then press [External Display Disconnected]. The option will change to [External Display Connected] and the display will be enabled.

For best performance of the console, disable display outputs you aren't using.

Titan should configure its output to match your monitor. However if this does not work for some reason you can manually set resolution from the toolbar. Click 'Tools' at the very top of the touch screen and select 'Control Panel', then 'External Monitor', then select the option to match the resolution of your monitor.

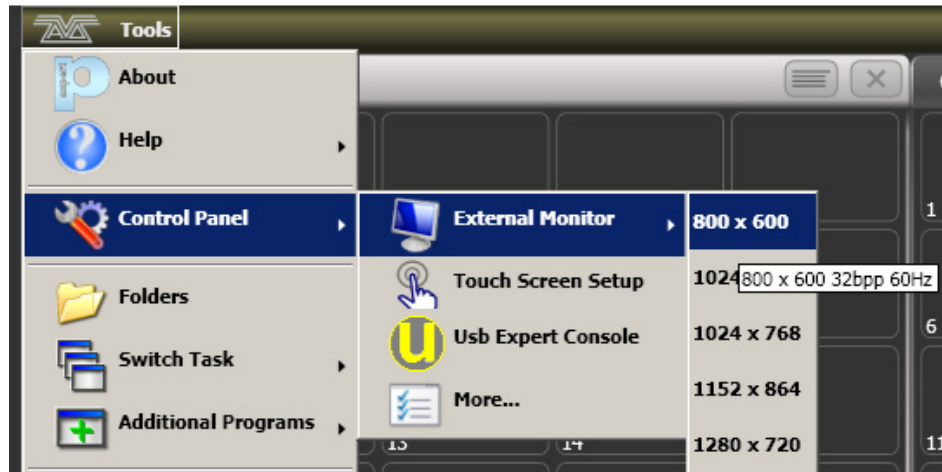

16.3 KEY PROFILES

The console allows you to reconfigure how the front panel buttons work to suit your method of working. You can save your settings as a Key Profile. Different profiles can be selected for different users or to enhance the operation of the console for a particular use.

There are standard Key Profiles for Run mode, Takeover Run mode, Program mode, Theatre mode and Nightclub mode. These standard profiles cannot be edited, so you always know how they will behave. You can create your own editable profiles using one of the standard profiles as a starting point.

The current settings of the playback buttons are shown on the screen related to each playback fader.



16.3.1 CREATING AND EDITING KEY PROFILES

To create or edit a profile, switch to System mode then select [Key Profiles]. You can then use the Manage Profiles menu to View, Edit, Add, Delete or Rename profiles.

You can also create or edit key profiles in the [Handle] tab of Playback Options.

Key Profiles can also be viewed from the Show Library window as described in section 3.7 on page 77.

When Adding a new profile, you can select an existing profile to copy settings from.

You can also edit Key Profiles from Program mode by holding <Avo>, then selecting [Edit Current Key Profile]. If the current key profile is one of the non-editable system ones, you are prompted to add a new profile or select an existing editable profile.

The current actions for the Black, Blue, Grey and Touch buttons are shown on the left side of the screen. Once you select a key type from the menu, the screen shows actions available for that type of button. Only the Sapphire Touch has black buttons.



The groups of keys you can set are as follows. The blue or grey fixture/palette buttons only exist on the Pearl Expert, on other consoles these settings will not do anything.

Fixtures: the blue, grey or touch key can be allocated to Disabled, Select, Flash, Swop, Latch. The “Latch” function is equivalent to putting the fader to full for that fixture and touching again returns the fader to 0.

Groups: the blue, grey or touch key can be allocated to Disabled, Select Group, Flash Fixtures, Timed Flash, Flash Master, Timed Flash Master, Swop Fixtures. You can select if the group function takes precedence over the flash function (if a handle has both group and flash functions) or vice versa.

Palettes: Only effective on Pearl Expert. The palette (grey) key can be allocated to Disabled or Select Palette. You can select if the palette function takes precedence over the flash function (if a handle has both palette and flash functions) or vice versa.

Cues: the blue or grey key can be allocated to Disabled, Flash, Swop, Latch, Preload, Go.

Chases: the blue or grey key can be allocated to Disabled, Flash, Swop, Latch, Go, Stop, Preload, Connect, Tap Tempo.

Cue Lists: the blue or grey key can be allocated to Disabled, Flash, Swop, Go, Go Back, Stop, Preload, Connect, Next Cue +, Next Cue -, Review Live Cue, Cut Next Cue To Live, Snap Back, Flash and Go, Timed Flash and Go, Release.

Macros: can be set to Select or Prefer Macro (the Macro function will take precedence over other functions stored on the button).

Options: allows you to disable the quick record function (double tap on empty handles).

Masters: this is divided into Standard Masters and Scene Master. For Standard Masters the options are Disabled, Selection, Flash, Latch, Tap Tempo, Nudge Up, Nudge Down, Release, Reset Multiplier, Multiplier x2, Freeze, Connect These last options are for rate and BPM masters, see section 13.1.4 on page 284.. Freeze can be useful to temporarily pause shapes or chases, or does a blackout if used with an intensity master..

For Scene Master the options are Disabled, Exit scene mode, Enter scene mode, Commit changes, Commit changes and exit scene mode, Enter or Exit scene mode, Enter or commit scene mode.

16.3.2 SELECTING A KEY PROFILE

To quickly select a Key Profile, hold the <Avo> Shift button and press [Select Key Profile].

16.3.3 INDIVIDUAL KEY PROFILES FOR PLAYBACKS

Each playback can have an individual Key Profile allocated to it. This allows you to customise the panel button functions differently for each playback. The Key Profile for the playback is selected using the [Handles] option on Playback Options. If the playback Key Profile is set to [Global], the default global profile for Cue / Chase / Cue List is used.

16.4 USER SETTINGS

The User Settings menu may be accessed from the System mode menu, and also from Program mode: hold down the <Avo> Shift button and press [User Settings].

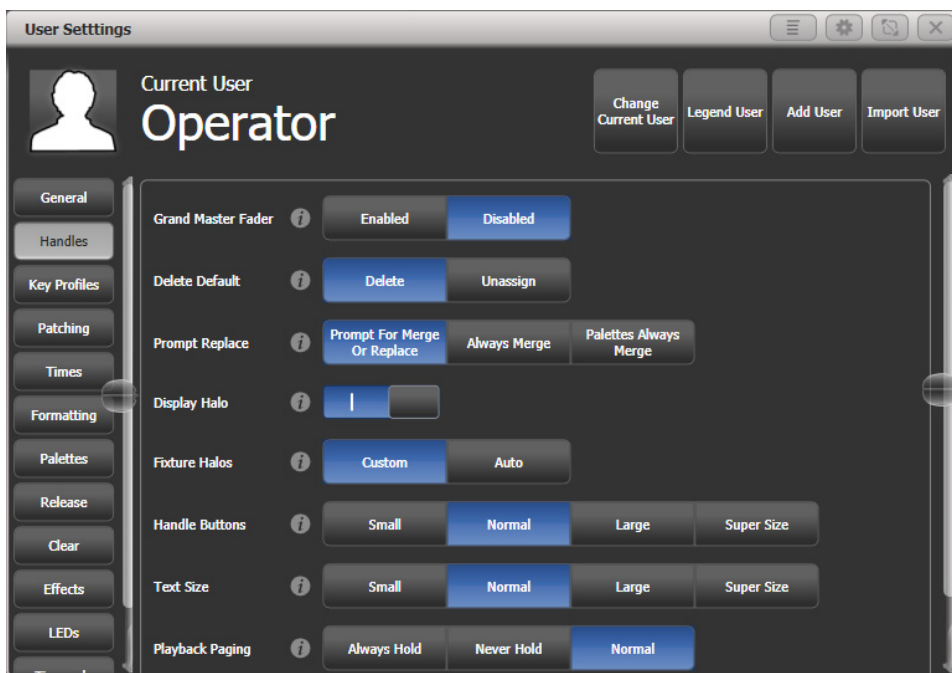

A window will open showing the user settings, or you can also set the same options using the softkey options. User Settings are individual for each User and you can change the User from this screen.

Click on the  button for a help window on each setting.

Options are divided into categories on the softkeys or down the left hand side.

16.4.1 GENERAL

Chase Snap: If enabled the Next Step and Prev Step buttons will snap to the new state. If disabled, programmed fades will be shown. This is the same function as the Snap button which features on some consoles.

Cue List Snap: If enabled the Next Step and Prev Step buttons will snap to the new state. If disabled, programmed fades will be shown.

Clear Record Mask: sets whether the record mask is cleared back to All Enabled when you enter the Record function, or whether it remains as you previously set it.

Copy Cues: sets whether tracked values will copy when you copy a cue from a tracked cue list.

Run Startup Playbacks: Allows you to globally disable startup playbacks from running. To enable Startup Playbacks you need to turn this on and set some playbacks as Startup using Playback Options.

System Render Rate (Hz): sets the output rate of DMX frames from 1-44 frames per second (default 40). You can reduce this if processing of a complex show is slowing down the console.

Lock Screen Background: sets a picture to be displayed when the console is locked. See section 3.4.4 on page 73.

16.4.2 HANDLES

Grand Master Fader: sets whether the Grand Master fader is enabled or disabled (some consoles do not have this fader). This can be handy if it gets broken or if you wish to disable it to avoid confusing inexperienced operators. The default setting is 'Disabled'.

Delete Default: sets whether items are deleted when you press Delete and double tap them, or whether they are released from the handle and become unassigned. Unassigned items can be reused from the Show Library.

Prompt Replace: sets the console action when you try to save to a handle or playback which is already used.

[Prompt for Merge or Replace] - the console will always prompt

[Always Merge] - the console will never prompt

[Palettes Always Merge] - the console will prompt unless you are saving a palette.

Display Halo: Allows you to turn off all coloured halos on buttons.

Fixture Halos: Sets how coloured halos are displayed on fixture buttons.

[Custom] – Only user defined halo colours are shown.

[Auto] – Fixture buttons are coloured using automatic fixture colours

Handle Buttons: sets the default size of the touch buttons to [Small], [Normal], [Large] or [Super Size]. This can be overridden separately in any window.

Text Size: sets the default size of the text used in touch buttons. Can be overridden in any window.

Playback Paging: [Playback paging] sets how the playback faders behave when you change page with a playback active.

[Normal] - sets the normal mode for the console type.

[Always Hold] - sets the standard behaviour for non-motorised faders where the fader keeps control of the active playback when the page is changed and has to be lowered to zero before a playback on the new page can be fired.

[Never Hold] - the standard behaviour for motorised faders where the fader always relates to the current page. To regain control of a playback from another page you have to go back to that page and level match the fader (which is done automatically by motorised fader). When a playback is active from another page the display area goes purple and the page number is shown at the top in light blue.

Current Handle World: Sets the handle world. See 3.5.2.

16.4.3 KEY PROFILES

Allows you to select and edit key profiles using the softkeys. See 16.3.

16.4.4 PATCHING

Warn Before Parking Fixtures: sets the console action when you patch a fixture which overwrites the DMX channels of another fixture. This causes the overwritten fixture to be "parked".

[Always] - console will warn you.

[Never] - console will park the fixture without warning you.

DMX Address: sets whether the DMX address of fixtures is shown in the fixture touch buttons.

Auto Groups: sets whether the console will automatically create new groups for fixtures when you patch.

Preset Palettes: sets whether preset palettes should be created when fixtures are patched. You can also turn this on when patching using the [Create Preset Palettes] softkey.

[Do Not Create] – no palettes will be created.

[Create On Workspaces] – palettes will be created in workspace windows.

[Create On Presets] – palettes will be created on preset buttons.

16.4.5 TIMES

Tempo Units: sets the units for displaying tempo. The options are [Beats per Minute] or [Seconds].

Connected View Sets: sets the console action when you change the speed of a connected chase. [Connected View Sets Temporary Chase Speed] means that the console will not save the modified speed, and the next time the chase is fired it will go back to its programmed speed. [Connected View Sets Chase Speed] means that the console will modify the saved speed of the chase.

Preload Time: sets a fade time for the Preload function, normally 2 seconds. This value would normally be set for quiet fixture movement.

Times Format: selects between HH:MM:SS format and Seconds format. In HH:MM:SS format the console will convert any number you enter into hours minutes and seconds.

Compensate for Rate Grand Master: If on (default), when a tempo is tapped on a BPM master it will not be affected by the Rate Grand Master being set to less than 100%.

16.4.6 FORMATTING

Channel Levels: sets how you enter channel levels when using numeric entry of levels.

[Channel Levels Set In Tens] - enter one digit for the channel level (e.g. 5 = 50%).

[Channel Levels Set in Units] - enter two digits, i.e. 50 = 50%.

Number Style: sets how channel values are displayed in Cue View and Palette View.

[Precise] - will include all decimal places.

[Rounded] - round to nearest whole number.

[Dynamic] - show decimals where appropriate, remove trailing zeros.

16.4.7 PALETTES

Quick Palettes: enables or disables the Quick Palette function. See section 6.2.3.

Minimum Palette Mode: Sets whether global or shared palettes can be created when recording palettes. You can use this to force the console to store all palettes as Shared.

Add New Palette Channels: sets whether new channels added into palettes will be added to playbacks using those palettes.

Auto Legend: sets whether new items will automatically have legends generated for them (colour scribbles for colours or descriptive legends for other functions).

Highlight Active Palettes: sets whether active palettes are shown as highlighted in the workspace windows.

Filter Relevant Palettes: sets whether palettes which do not apply to the selected fixtures will be greyed out.

Master Palette Time: Sets the default fade time to be used when recalling palettes live. See 13.1.14.

Master Palette Overlap: Sets the default overlap to be used when fading palettes.

Record Nested Palettes: If enabled, palettes containing other source palettes will be updated when you change the source palette.

Preset Palettes: This is the same as the option in the Patching section, see above.

16.4.8 RELEASE

These settings can also be changed from the Release menu.

Release To Home: If enabled, when the last playback is released fixtures will return to home values. If disabled, LTP channels will remain set.

Master Release Time: Sets the default release time.

Release Priority: The playback priority used with the Release menu or when running Release macros.

16.4.9 CLEAR

These settings can also be changed from the Clear menu.

Auto Reset Mask: When enabled, the Clear Mask will reset to include all attributes after every clear.

Zero Preset Fader Levels: When enabled, intensity levels set on fixtures patched to fader handles will be zeroed when Clear is pressed. If disabled the levels will remain set but will be removed from the programmer.

Release to Playback Values: If enabled, LTP channels will release to the values set in the last playback when Clear is pressed. If disabled, LTP channels will not change when Clear is pressed.

Clear Cue Times: If enabled, resets cue times in the programmer to defaults when Clear is pressed. If disabled, cue times set in the programmer will remain.

Clear Rate Settings: If enabled, resets the rate settings in the programmer to default when Clear is pressed. If disabled, rate settings set in the programmer will remain.

Clear Direction: If enabled, resets direction in the programmer to default when Clear is pressed. If disabled, direction set in the programmer will remain.

16.4.10 EFFECTS

Swop Shapes: Sets how shapes react to Swop mode.

[All Shapes] – All running shapes from other playbacks are stopped

[Intensity Shapes] – Only intensity shapes from other playbacks stop

Shape Behaviour: sets whether Key frame shapes will overlay all other values or will work in LTP mode where later changes will override the shape. See page 7.2.3.

16.4.11 LEDS

Fixture LEDs: Sets how the button LED behaves when a fixture is patched to a fader handle.

[Show Occupation] – the LED shows handle empty and selection state

[Mimic Intensity] – the LED shows fixture intensity level.

The options below only function when [Show Occupation] is selected.

LED Empty Level: Sets level for unpatched handle.

LED Occupied Level: Sets level for occupied but unselected handle.

LED Programmer Level: Level if fixture is in the programmer.

LED Selected Level: Level if fixture is selected.

16.4.12 TIMECODE

Kill Out of Range Playbacks:

MIDI Device ID: Sets the Device ID when using MIDI show control commands.

MIDI Glitch Detection: Enables the glitch options below.

MIDI Glitch Tolerance: Sets the maximum amount of time a MIDI timecode can jump by without being seen as a glitch.

MIDI Glitch Timeout: Sets the amount of time the console should ignore MIDI timecode for after a glitch has been detected.

16.4.13 WHEELS

Wheel Sensitivity: The sensitivity of the encoder wheels, and the pan/tilt threshold settings can be adjusted using this option. Wheel sensitivity is adjusted using Wheel A and the current level is shown on the display.

Pan & Tilt Threshold: Enables or disables the pan/tilt threshold options below.

Pan Threshold: Sets the sensitivity of the Pan control if above option enabled. Larger numbers make Pan work slower.

Tilt Threshold: Sets the sensitivity of the Tilt control if above option enabled. Larger numbers make Tilt work slower.

Auto Connect: sets whether Chases and Cue Lists will auto-connect to the wheels when the playback is fired. The options are [Off], [Chases], [Lists] and [Chases and Lists].

Auto View on Connect: sets whether the view window for the playback will open automatically when the playback is fired. The options are [Off], [Chases], [Lists] and [Chases and Lists]. If both Auto Connect and Auto View on Connect are set to [Chases and Lists] then firing a playback will automatically connect the playback and open the view window for the playback.

Press and Hold Fan: [Press and Hold Fan] changes the Fan function so that it only works while the Fan button is held. This avoids the common user error of leaving Fan turned on accidentally.

16.5 DMX OUTPUT MAPPING

There are various ways to connect fixtures to the console. As well as the XLR sockets on the console, you can connect fixtures using Ethernet and wireless links.

All consoles can output up to 16 universes except T1 which is limited to one single universe and T2 to two universes.

If you need to output more universes, you can network the console to one or more Avolites TitanNet Processing (TNP) nodes. This off-loads the DMX processing, allowing the console to control up to 64 universes of DMX in total.

- The software does not actually limit the number of universes from a single console to 16, but performance of the console will be degraded. A warning will be shown in the processing load section of the TitanNet overview.

16.5.1 CONFIGURING DMX OUTPUTS

Switch the console to System mode and select [DMX Settings].

The screen will initially show the node tab relating to the console itself. It shows a list of available DMX *nodes* (places where you can send the DMX to) on the left, and a list of the available DMX *lines* (outputs generated by the console) on the right. Each DMX line can send data to one or more nodes. If you assign more than one node to a line, those nodes receive duplicated data. If you have ArtNet/sACN nodes or TNP units connected they will show on the left hand side.

On the right hand side, under each DMX Line there is a list of which nodes are linked to that line. The default setting on a new show is for the physical DMX outputs on the console to be linked to the first DMX lines.

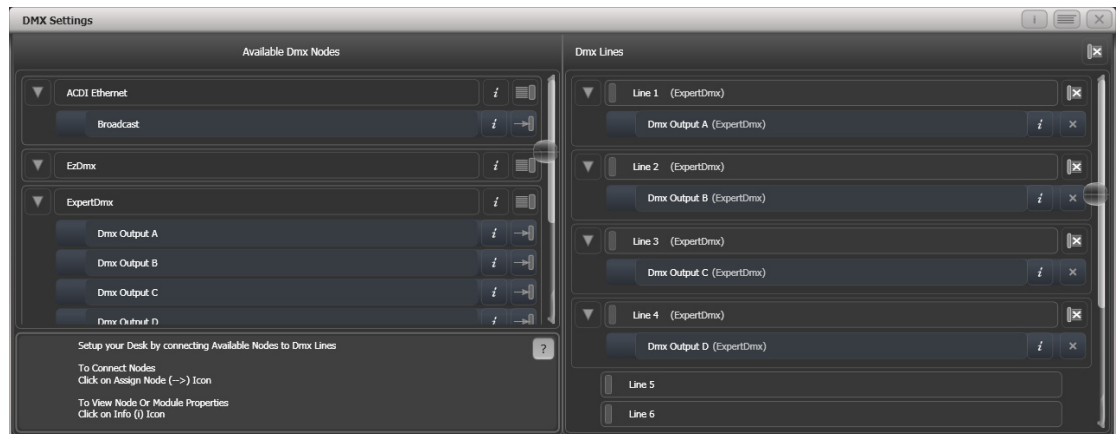

You can individually assign Nodes to Lines using the arrow button, or assign all Nodes of the same type using the group assign button. For example, to assign each XLR output socket on the back of the console to a DMX line, you would click on the Group Assign button of the ExpertDMX nodes.

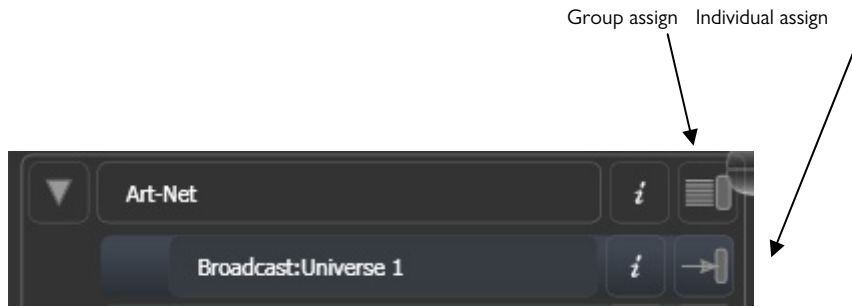

To assign a node to a line, click on the arrow on the node (the node will be highlighted), then click the line you want to assign to it.

To delete a node from the DMX lines, click on the X button. To delete all nodes from a line, click on the Group delete button

You can show information about the DMX nodes, or the DMX lines, by clicking the i button. For Ethernet/network type nodes, this allows you to set detailed properties such as IP address ranges and net masks.

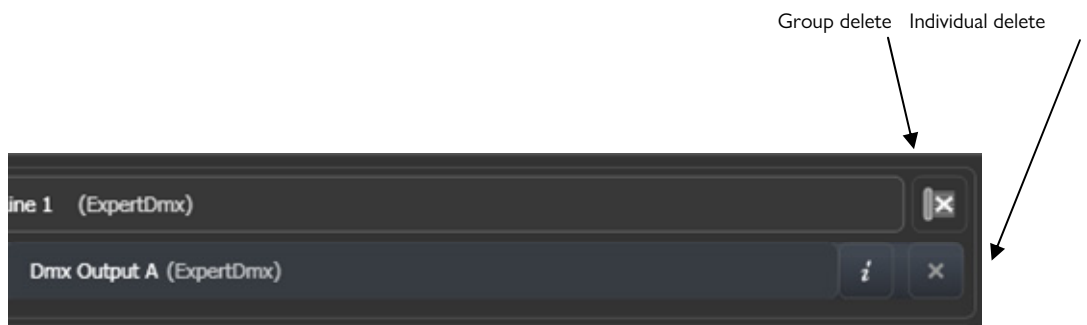

If you have TNP's connected, these can be individually configured using the tabs across the top of the screen.



When transferring shows between different console types, and especially when you have used the simulator, it's a good idea to check the DMX output settings to make sure the settings are what you expected. If you created a new show on the simulator, no outputs will be connected.

16.5.2 MODULE PROPERTIES

A module is a method of sending DMX (such as ArtNet, or sACN) and can be thought of as a collection of nodes.

You can set properties for ArtNet or sACN by going to the DMX Settings window (switch to System mode and select [DMX Settings]) and then click the cog icon at the right hand side of the module name.

This allows you to adjust settings for each module, and to select which network adapter to use to output the protocol. All consoles except Quartz and Expert have two network adapters, Quartz has one, and on Titan Mobile and Simulator this depends on your computer; many laptops will have a wired network adapter and also a Wi-Fi (wireless) adapter, both of which will be shown.

SACN PROPERTIES

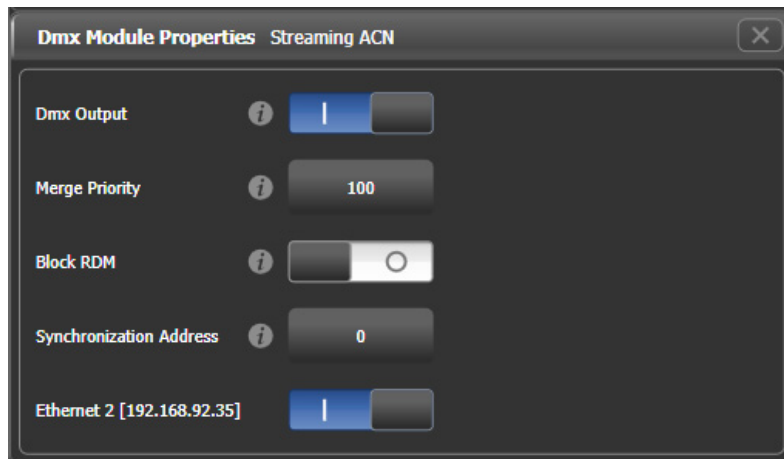

DMX output: Allows you to temporarily disable the output

Merge Priority: (0-200) The sACN specification allows multiple consoles to send out DMX on the network. The priority value tells the receiving node which console to listen to if it gets DMX from more than one, higher values take priority. You would normally use this to connect a backup console with a lower priority setting.

Block RDM: If enabled, RDM traffic is blocked on this module.

Synchronization Address: If not zero, sets the universe used to synchronise the DMX frames sent from the console. Listening devices will receive all DMX frames and then wait for a packet on the synchronisation universe before using or retransmitting the DMX frames. Synchronous sACN reduces tearing effects which can result from non-synchronised universes. If set to zero, synchronisation is disabled.

Ethernet xxx: Selects whether you want this protocol outputting on this Ethernet adapter. If there are multiple adaptors in the system you can select more than one, and identical information will be sent out on each one.

ARTNET PROPERTIES

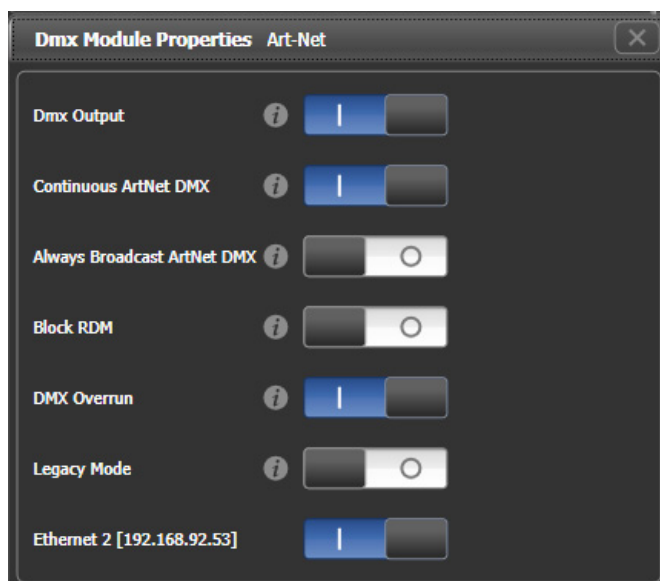

DMX output: Allows you to temporarily disable the output

Continuous ArtNet DMX: The ArtNet specification allows the console to only send out changes in the DMX. This setting makes the console send the ArtNet packets continuously even if there is no change.

Always Broadcast ArtNet DMX: Sets all ArtNet packets to Broadcast mode, meaning they are sent to all nodes. Otherwise the packets are addressed to the specific node they are intended for, which reduces network traffic but requires more careful setting up of network addresses.

Block RDM: If enabled, RDM traffic is blocked on this module.

DMX Overrun: Some ArtNet nodes ignore changes until they are sent more than once. If this option is enabled then at least 3 packets are sent for every change

Legacy Mode: If enabled, ArtNet is broadcast continuously from the console at a high rate. May affect console performance.

Ethernet xxx: Selects whether you want this protocol outputting on this Ethernet adaptor. If there are multiple adaptors in the system you can select more than one, and identical information will be sent out on each one.

16.5.3 DMX OVERVIEW

If you select the DMX Overview tab at the top of the screen, you can see all the TNP's which are connected and which output lines they are allocated to.

The screenshot displays the 'DMX Settings' window. On the left, a list of 14 DMX lines (Line 1 to Line 14) is shown, each associated with a specific device (PEXP-00741 or DFE-00053, DFE-00052, DFE-00051, DFE-00050) and labeled '(ExpertDmx)'. Colored lines connect these DMX lines to the physical outputs of the devices. On the right, a detailed view of the 'DFE-00053' node is shown, including its IP address (10.2.0.53), network adaptor details, ping status, and processing load.

The left side of the screen shows the 64 possible DMX output lines on the console. To the right of this are the processing nodes which are connected, the top one being the console itself. Each node shows how the lines are allocated to the physical outputs on the device. Clicking this area will open the detail tab for the node.

Clicking any one of the nodes will show detailed information about that node on the right, including the IP address, number of available processing slots, number of lines

assigned, status of the connection with the node, and the processing load of the device. If more lines are assigned than the maximum number of slots, a warning will be displayed.

If a show is loaded that had fixtures and lines assigned to processing nodes which are no longer found on the TitanNet network, a screen will appear listing nodes in use and available nodes, giving you the option to reassign the lines.

16.5.4 DMX MERGE

The DMX merge window allows you to set up where DMX will be output in a system where you have multiple consoles or processing nodes connected.

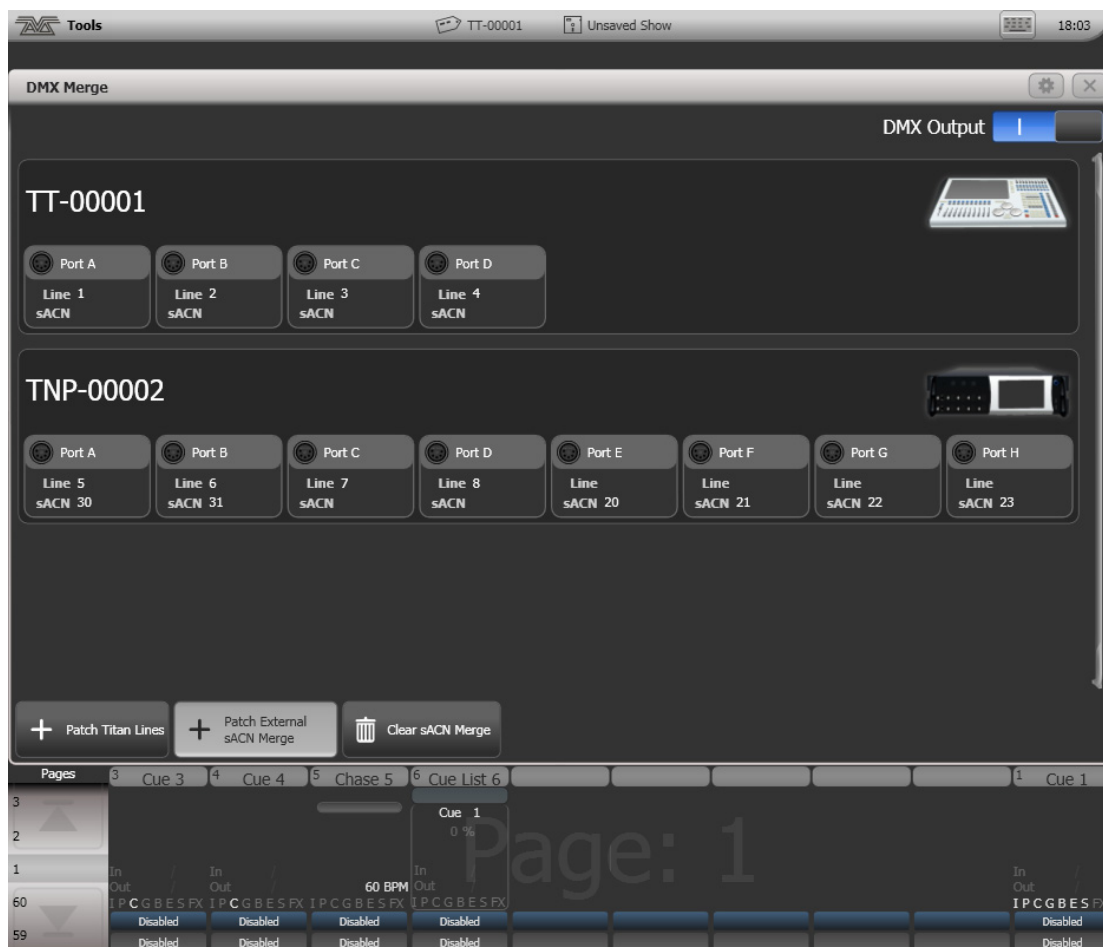

To configure an output port, click on Patch Titan Lines, enter universe number then click on a port to assign.

To remove an assignment, click on Clear sACN Merge then select a port.

The DMX Output switch can be used to disable all DMX output.

16.6 CURVES

The console provides a variety of curves which set how the console tracks fades in playbacks; either the same speed all the way (linear), or starting and ending gently but faster in the middle, and various other options. Curves are used in various places in the console, one example is in the [Playback Options] menu (see section Playback options on page 219).

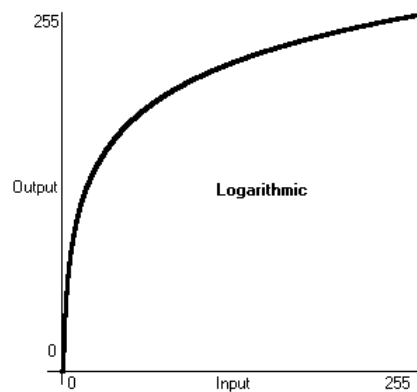
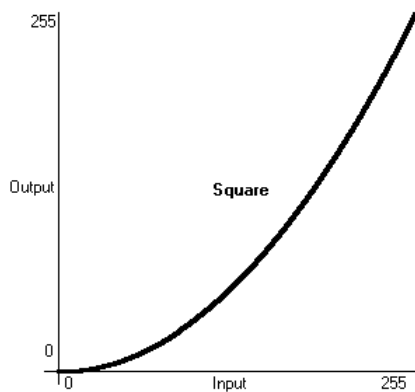
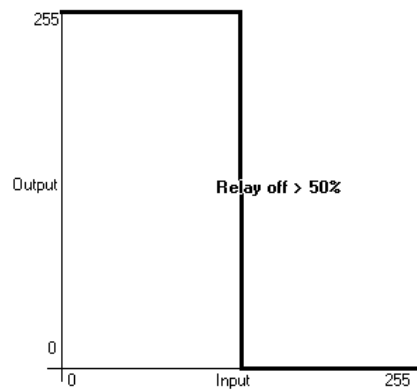
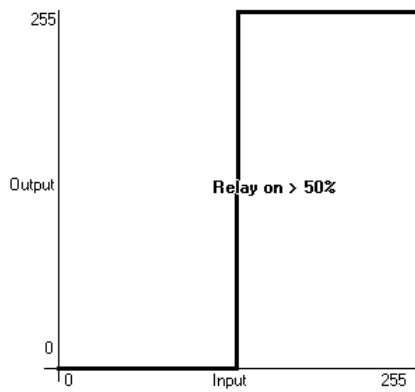
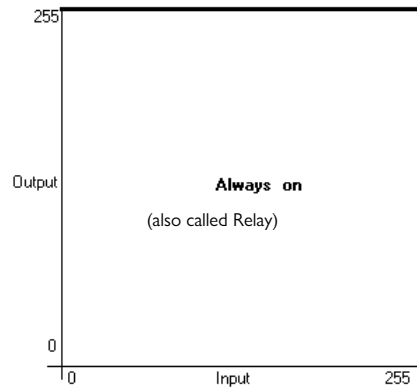
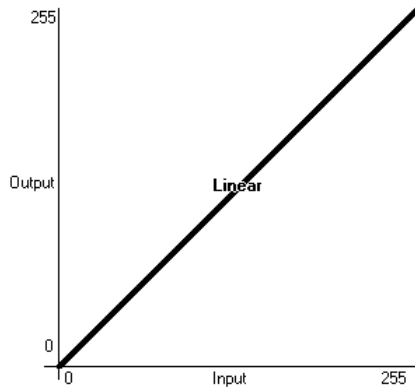

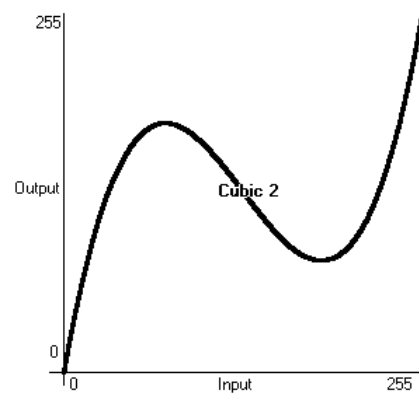
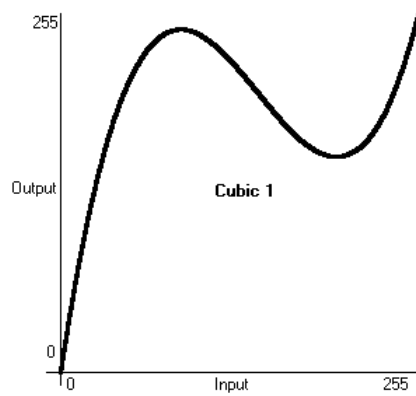
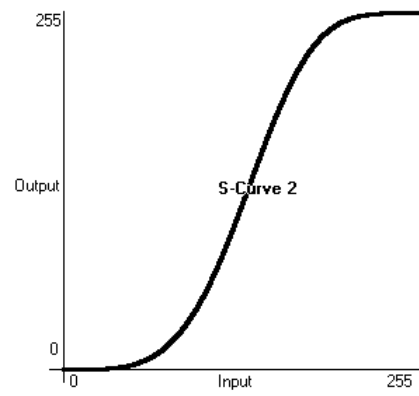
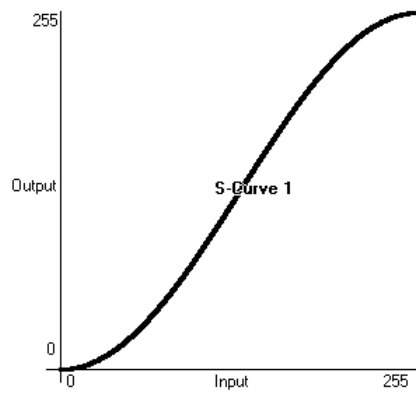
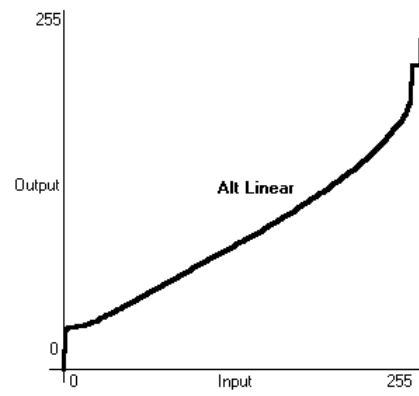
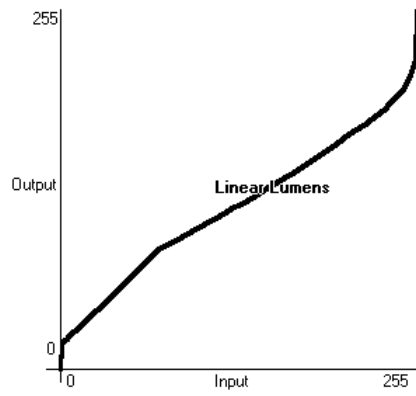

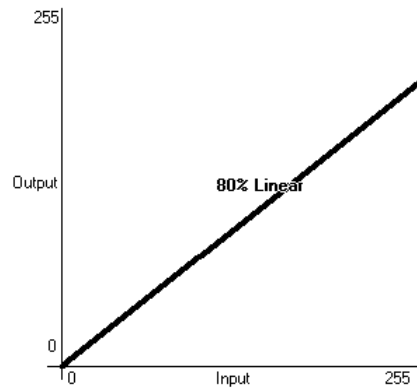
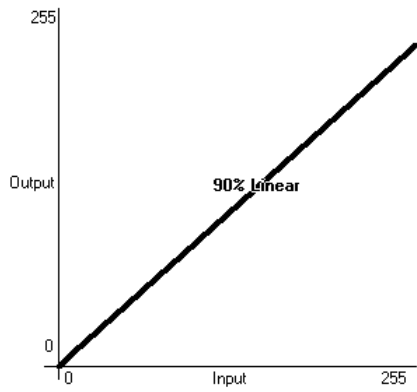
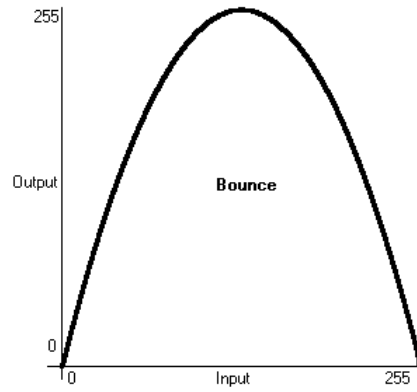
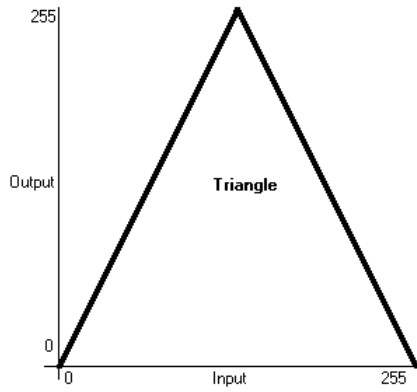

16.7 UPGRADING THE SOFTWARE

The console operating software is under constant revision by the Avolites team. You can always download the latest version of the software from the Avolites website:
<http://www.avolites.com>.



From v10 it is possible to keep the older versions of Titan installed on a console when you install a new version, which is useful for backwards compatibility if you need to load a show created in an older version. To swap between versions go to Switch Software on the Tools menu.

- The Titan Mobile, Titan Go and Editor/Simulator software is installed simply by running the “PC Suite” installer program as with any other Windows application. Please ensure you have exited the Titan software before running the installer.
- If you are upgrading the software from a version earlier than v12, you will have to obtain an AvoKey USB dongle from Avolites and license the software. See the next section for details of how to do this.

Software upgrades for consoles are installed from a USB pen drive.

Having downloaded a new version of software, copy it to the USB drive and install it on the console like this:

- 1> Copy the installer file to a USB drive and insert into the console.
- 2> On the screen tools menu, stop the console software using the Shutdown Software button at the bottom of the list.

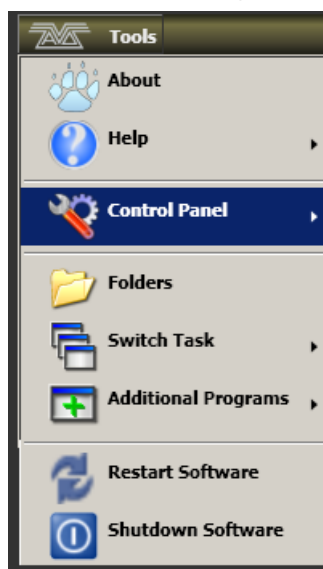

- 3> Open the tools menu again, touch the Folders icon and navigate to the drive where the upgrade file is found.
- 4> Run the installer by double clicking/double tapping.

- 5> When the installation has completed, shut down the console and restart it. This will allow any operating system updates to install.

16.8 RECOVERING/REINSTALLING THE CONSOLE

The console runs on an embedded PC system, and like all computers, there is a possibility of system failure. The console software can be reloaded using the recovery USB stick provided with the console, or you can download a recovery disk creator application from the “Downloads” tab on the Avolites website which will automatically create a recovery stick.

It may take up to 60 minutes to reinstall the software on the console.

There are three types of recovery available:

	Version installed	Shows	Personalities
Standard Recovery	Two most recent	Preserved	Preserved
Factory Restore	Recovery version + most recent	Deleted	Recovery version
Full Erase	Recovery version	Deleted	Recovery version



Using “Factory Restore” or “Full Erase” will delete all settings and files from the console including show files and user personalities. Any files should be saved to a USB stick before continuing.

Detailed instructions on creating and using a recovery stick can be found with the recovery creator on the Avolites website; depending on the variety and age of your console there are a number of different methods required. The basic procedure is as follows:

16.8.1 INSTALLATION INSTRUCTIONS

- 1> If recovering a version earlier than v11.1, you will need to set the console to boot from USB (see instructions on the Avolites website, which vary depending on your console)

- 2> Start console and wait while the memory stick boots up, this can take up to 3 minutes.
- 3> Once the memory stick has booted, the touch screen will display 'Welcome to (Console Name)', touch Next to continue.
- 4> Please read to the bottom of the licence agreement then touch Agree to accept.
- 5> Select the type of recovery you want to perform (see table above)
- 6> On the next screen check the serial number of the console - this is the number written on the back of the console and should be already filled in for you.
- 7> Touching Install will then begin the recovery
- 8> Once complete unplug the memory stick and touch the Restart button.

After starting the console will install all the software and drivers required to run. This takes approximately 30 minutes to complete during which the console will reboot a number of times. Please do not switch off the console during this process.

16.8.2 SOFTWARE LICENSING

From v12, the software is licensed using an AvoKey USB device.

The Authenticator wizard will take you through the steps to license the software on your console or computer. Once the license is stored on the AvoKey, you should not need to repeat the licensing. For Titan Mobile or T1/T2 dongles, this allows you to use different computers without relicensing as long as the Avolites hardware is connected.

For more details see <https://www.avolites.com/avokey>

16.9 RELEASE NOTES

The Release Notes contain details about features added, improvements, bugs fixed and known issues in each release of the console software.

Release notes for the version of software running on your console can be found by clicking the Help → Release Notes option on the toolbar.

The most up-to-date version of the Release Notes can be found on the Avolites website www.avolites.com.

17. FIXTURE PERSONALITIES

For each type of fixture, the console has a “personality” file which tells it how to control the fixture, which channel is the dimmer (HTP) channel, and a large amount of other fixture-specific information. When you patch each fixture, you tell the console which personality to use for it.

The console holds a personality library containing all commonly used fixtures, but new fixtures are appearing all the time and Avolites are constantly updating the library.

We recommend that you should update the library from time to time to take advantage of new fixtures, as well as receiving bug fixes for personalities and new features which may be added such as subfixtures.

17.1.1 DOWNLOADING FIXTURE PERSONALITIES FROM AVOLITES

The Avolites website lists all fixtures for which personalities have been created. You should look here first if the console does not contain a personality for your fixture. The address is <http://personalities.avolites.com>

The screenshot shows the Avolites Personality Library website. The top navigation bar includes Home, New And Updated, Request, Bug Reports, Advanced Search, Download, and Links. The main content area is divided into two sections. On the left, there are search filters for Desk, Manufacturer, Updated since, and Search. Below these is a list of fixtures. On the right, the details for the Alpha Beam 1500 are shown, including Manufacturer (Clay Paky), Name (Alpha Beam 1500), Light Type (Moving Head Spot), and Manufacturers Website (http://www.claypaky.it/). Below the details is a table of Personality Files.

Fixture Name	Desk	File Name	Name On Desk	Last Update	DMX	Disk	Cache	Details	Report Bug
Alpha Beam 1500	Diamond 4 Titan	Clay Paky_Alpha Beam 1500.d4	Alpha Beam 1500	25/05/2016					
Alpha Beam 1500	Pearl/Azure /Sapphire	CPAB15KS.R20	Alpha Beam 1500 Standard 24DMX	23/08/2010	24			Standard 24 DMX, 16bit 24 DMX Channels	
Alpha Beam 1500	Pearl/Azure /Sapphire	CPAB15KV.R20	Alpha Beam 1500 Vector 28 DMX	23/08/2010	28			Vector 28 DMX, 16bit 28 DMX Channels	
Alpha			Alpha Beam 1500 Standard					Standard 24	

All available fixture personalities are listed down the left side of the screen. You can use the boxes on the top left to filter the list to show fixtures from specific manufacturers, or fixtures available for a certain console, or to search for a specific fixture name.

Click on the fixture name to open the details in the right hand window. This shows all the personalities available for that fixture type (if you have entered the console type on the top left, only personalities for that console will be displayed).

If the personality is included in the standard library (cache) then the column will be ticked.

If there is a personality listed for your fixture, the simplest thing to do is to update the complete personality library as described in the next section.

17.1.2 UPDATING THE PERSONALITY LIBRARY ON THE CONSOLE

Download the current Titan personality library by clicking on “Titan Fixture Library” at the personality website home screen, or the disk icon in the Cache column for any fixture. Alternatively you can get this file by clicking on the Download link at the top of the screen, then clicking on “Titan Fixture Library”.



Updating will overwrite any custom personalities you have stored in the library. To avoid this, store your custom personalities in the user personalities folder (see next section for details).

To update a console use the following procedure:

- 1> Copy the downloaded file *TitanFixtureLibrary.exe* onto a USB pen drive and plug in to the console.
- 2> Click the 'Tools' menu on the toolbar, then the folder icon on the menu.
- 3> Locate the downloaded file on the USB drive and double click on it to run it. Click 'Ok' on the warning box.
- 4> Shut down and then restart the console (using the Restart Software button on the screen Tools menu is OK).

To update Titan Mobile, Titan Go or Titan Simulator:

- 1> Locate the downloaded file *TitanFixtureLibrary.exe* and double click on it to run it. Windows may show a warning about an unrecognised file
- 2> Click 'Ok' on the Windows User Account Control warning box.
- 3> When the installation has completed, shut down and then restart the Titan software.

- The console caches the FixtureLibrary folder into memory when the Patch option is first used, so you need to restart the console software (from the Tools menu) to ensure new fixture personalities are loaded.
- Once a fixture is patched, its personality is embedded in the show file. Any changes to the fixture library will not affect fixtures patched in the show. You can use the [Update Personality] option in the patch menu to update patched fixtures if you need to.

17.1.3 USER/CUSTOM PERSONALITIES

Using the Personality Builder application installed with the console software, you can create your own personality if you wish to modify the behaviour of a standard personality or you have a fixture the console has never heard of and need to get it working quickly.



The console loads the fixture library into memory when the Patch option is first used, so after creating a new personality you need to restart the console software from the Tools menu or it will not show up.

You can incorporate your custom personality into the standard fixture library on the console, however there is a danger that it will be overwritten when you next update the Fixture Library from Avolites.

To avoid this the console provides a special folder for user-provided personalities located at D:\Personalities

If you are using Titan Mobile, Titan Go or the Titan Simulator, the folder is located at \Documents\Titan\Personalities

When patching fixtures, this folder is searched first before the library. If a suitable Fixture Personality is found, the console will use it rather than using the library. This folder is not affected when the personality library is updated.

17.1.4 REQUESTING A NEW FIXTURE PERSONALITY

If a personality does not exist for your fixture, Avolites will create one for you. Click on the "Request" link on the above web page to submit your request. A list of current requests is shown, so you can check if someone else is asking for the same thing.

Your new personality will be incorporated into the library – to install the new personality, download and install the latest personality library as described above.

17.1.5 REPORTING A PERSONALITY BUG TO AVOLITES

If you find a problem with a fixture personality, Avolites would like to know about it so it can be fixed. Search for the personality on the website then click on the "Report Bug" icon on the right of the screen. If you click on the "Bug Reports" tab at the top of the window, a list is shown of currently outstanding problems, so you can check if someone else has already reported the problem.

17.1.6 IN AN EMERGENCY

The console contains a selection of "Generic" fixtures which you can use in an emergency if you need to operate a fixture with no personality. When patching, go through the manufacturer list until you find [Generic]. In this section (among other fixtures) are the following:

Multi-DMX: Has up to 10 DMX channels, all channels are LTP. You can select from 1-10 channels on the Mode screen. Press Attribute Bank and use the softkeys to select channels.

Generic RGB: Allows you to control an RGB fixture such as LED colour changers. This offers 5 modes:

1=Dim 2=R 3=G 4=B

VDim 1=R 2=G 3=B

1=R 2=G 3=B 4=Dim

VDim + 4xRGB

4xRGB.

VDim is a virtual overall dimmer channel for fixtures without a DMX dimmer control. When you use the Dimmer attribute the console will adjust the RGB levels accordingly.

18. NETWORKING THE CONSOLE

There are a number of ways for the console to communicate with lighting fixtures beyond the traditional DMX sockets, and these are described in this chapter.

You can also connect networked processing nodes, which allow you to control up to 64 universes of DMX.

The console may also be networked with other Titan consoles for multi-user control, and for backup.

At the end of the chapter is a section which aims to cover the basics of IP addressing, which is essential for various features on the console such as Art-Net.



Lighting networks need to transfer of large amounts of data. For best reliability you should use network wiring which is dedicated to the lighting system and physically isolated from other networks, and uses simple hubs rather than intelligent switches.

Connecting to an existing network with other network traffic is possible but can lead to problems both with the lighting equipment and with other IT equipment on the network. Intelligent Ethernet switches may drop or block lighting data. If you need to do this please read about the IP addresses you should use, in section 18.4.5.

If the console has multiple network ports, DMX will be output on all ports. You can set this from the DMX module properties in the DMX Settings window, each port is listed with a switch to enable or disable it.

18.1 CONNECTING THE ARENA TO A NETWORK

The Arena console is different to the other Titan consoles because it has a built-in network switch and an optical network connection (optionally 2 optical connections).

This section applies only to the Arena console.

18.1.1 OPTICAL CONNECTIONS

The optical network connector is a Neutrik opticalCon Duo which uses multimode fibre. A single connector is fitted as standard, but a second can be fitted on request. The stage end of the connection normally plugs into the Avolites TitanNet Switch (TNS) rack unit which provides standard wired ethernet connections. If you want to connect to a different optical switch you should contact Avolites for advice.

18.1.2 WIRED ETHERNET OUTPUTS

The Arena console has an in-built 1Gb TitanNet switch (TNS) that is directly connected to the console Main board on network connection 1. The network switch has 4 ports available on the back of the console.

The mainboard Network Connection 2 is available on the EtherCon connector at the back of the console and marked as "secondary Ethernet" on the back. We recommend

that this should only be used if you need to connect to two different networks, for example the show network and an office network for documentation.

The network switch and the controller for the switch both use an IP address. When the controller IP address is set, the network switch will use the next one (for example controller 10.19.0.50, network switch becomes 10.19.0.51)

18.1.3 CHANGING THE IP ADDRESS OF THE NETWORK SWITCH (TNS)

The controller and network switch IP address do not need to be changed unless they overlap other devices on the network. The factory default is 10.19.aa.bb where aa.bb is the serial number of the console. (01.124 is serial number 379 or 255+124)

To change the IP address of the TNS in the console:

- 1-Open USB expert from the Tools menu
- 2-Select the TNS panel

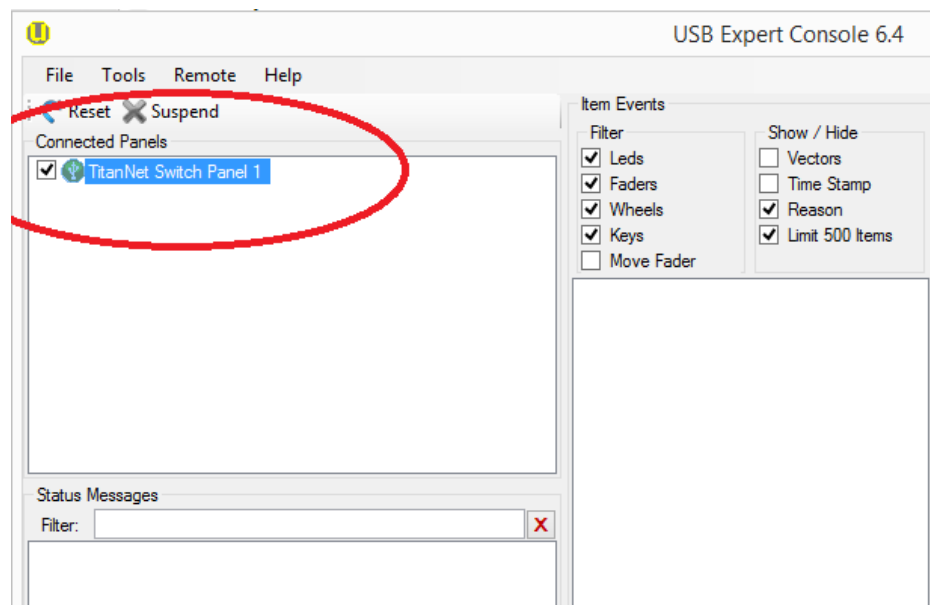

- 3-In the IP Address dialog, set the new IP address.

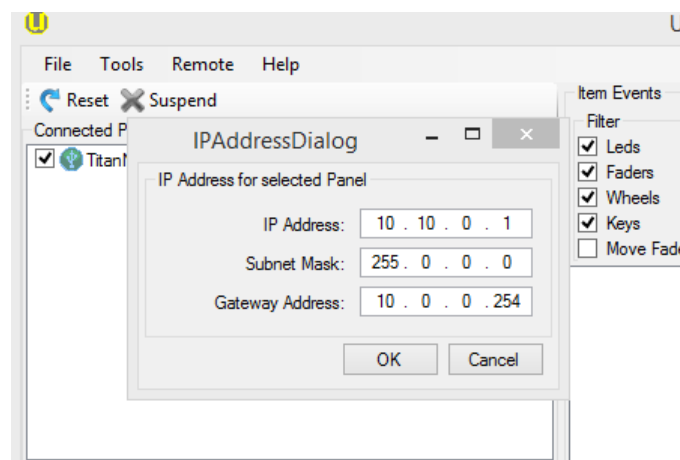

18.1.4 POWER AND UPS BEHAVIOUR

The TitanNet switch in the console runs from the same UPS as the console itself, so if power fails the switch will continue working.

When you power down the Arena, the UPS will continue to power the internal switch for about 5 minutes. This is to allow you to restart the console without interrupting the network (for example if you have connected a backup console via the Arena switch).

18.2 CONTROLLING FIXTURES OVER A NETWORK

Before the console can talk to another device over the network, it has to be given a unique network address. This is called its “IP address”.

18.2.1 SETTING THE CONSOLE'S IP ADDRESS

We recommend that you use the console's automatic IP setting function. However, if you need to you can also set the IP address using Windows Control Panel as shown on page 351.

```

1> Switch to System mode and press [Network Settings]
2> Press [Local Area Connection].
3> Press [Subnet Mask] and ensure it is set to 255.255.255.0
4> Press [Set IP 2.*.*]
5> Press [Save settings]
6> <Exit> system mode.

```

- Some equipment may operate on IP addresses 10.*.* (softkey D) – see later in this chapter for details.
- If you need a non-standard IP address range you can use softkey A.

18.2.2 SETTING UP DMX OUTPUTS

The console has 64 DMX output lines, of which the console itself can output 16, with further lines available using networked DMX processing nodes. The T1 dongle is limited to one DMX line, T2 to two DMX lines. The lines may be routed to physical DMX sockets and/or to network nodes.

Section 16.5.1 on page 330 tells you how to set up this routing, and an example is given in section 18.2.4 on the next page.

18.2.3 A SIMPLE ART-NET SYSTEM

There are various different systems for sending lighting control information over a network. One of the most widely supported is Art-Net.

Art-Net is not specific to one range of products, and is recognised and implemented by a growing number of manufacturers. Many products (such as Dimmers and Moving lights) can accept the Art-Net signal directly, so there is no need to convert the signal to DMX. Most people will, however, need to output DMX to their equipment and this can be done using an Art-Net to DMX converter.

In the following diagram, an Art-Net compliant Console (such as a Titan console) is connected via a network hub to an Art-Net compatible dimmer and 2 DMX conversion boxes.

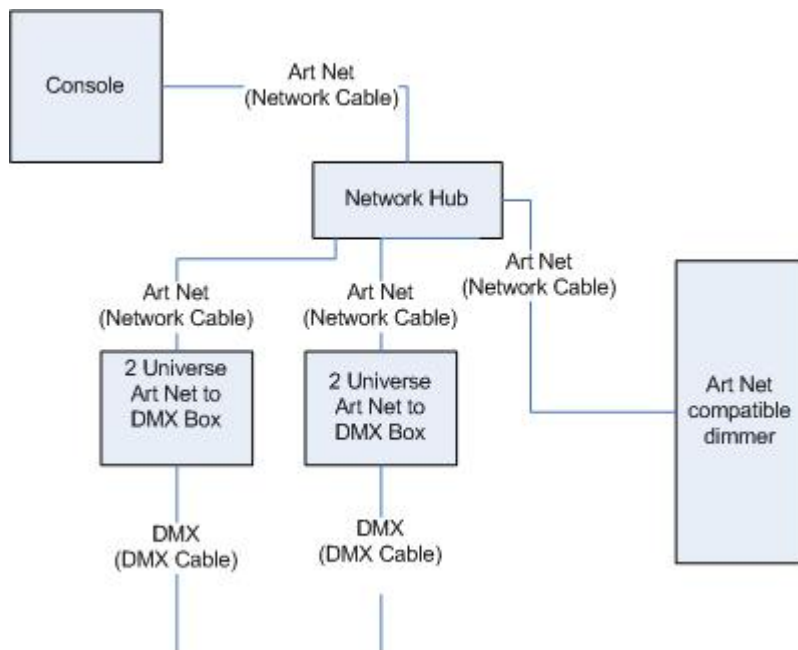

Once the system is connected together, the different outputs (or Nodes) can be configured.

- The dimmer is given the start address of 200
- The 1st DMX box is set to universe 1 and universe 2
- The 2nd DMX box is also set to universe 1 and universe 2

The console is then used to set the DMX lines to the Art-Net nodes.

It is important to remember:

- Each Art-Net to DMX box (or compatible Dimmer, or compatible moving light) is a device,
- Each device may have one or more nodes(i.e. the Art-Net to DMX box has 2 nodes, these are the 2 DMX outputs; the dimmer itself is a node),
- Each node can be set to a Universe (1-256). This universe is equivalent to a 512 channel DMX line

You can then specify which console line is assigned to each node. A console line can be assigned to multiple nodes (this will duplicate the DMX universe), but each node should have only one console line assigned to it.

Here, the console assigns the following:

- Line A to Box 1 universe 1 and box 2 universe 1
- Line B to Box 1 universe 2
- Line C to Box 2 universe 2 and the dimmer rack

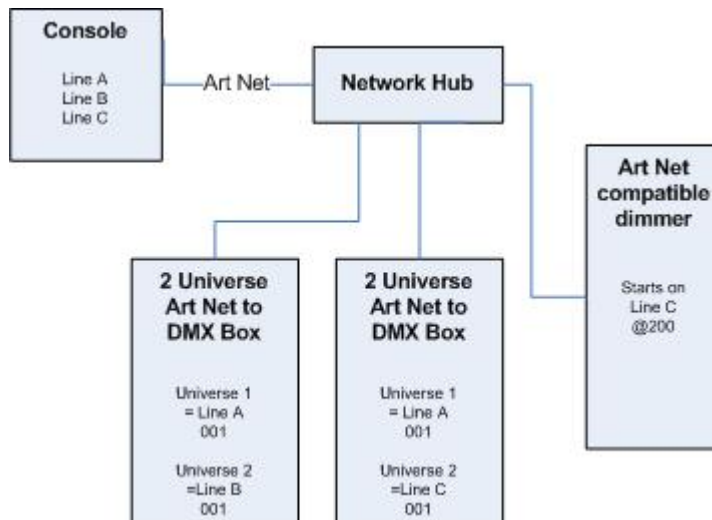

18.2.4 SETTING UP AN ART-NET SYSTEM

For this example, it is assumed that you will connect the console to an Art-Net DMX output box (such as an Artistic License Net-Lynx) via a network hub.

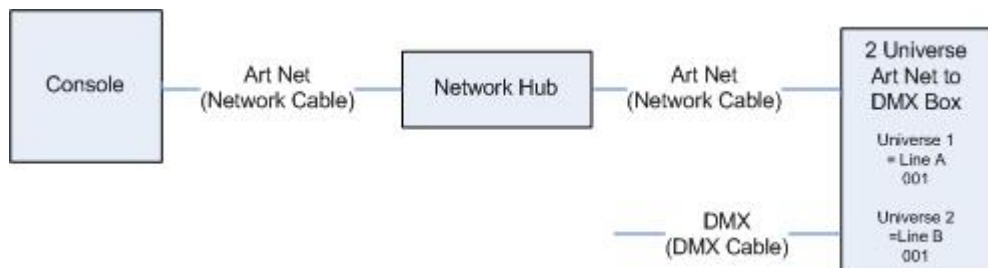

Using standard RJ45 ethernet cables, attach the devices together.

- If you are using a hub/switch as shown above, use straight-through patch cables. If you are directly connecting the console to another Ethernet device you need to use crossover cables.

Set the Net-Lynx box as follows:

- Subnet Mask = 0
- DMX A Universe = 1
- DMX B Universe = 2

A lot of Art-Net devices, including the Net-Lynx box, are set to IP address 2.x.x.x as default, and can be set to 10.x.x.x using an option jumper, so you should check what the setting of your device is.

If your Art-Net devices need to be set to a non-standard IP address, then in steps 1 and 2 you need to use Windows Control Panel to set the console to that address range instead of 2.x.x.x

With everything connected, start the console.

- 1> Ensure the console has an IP in the 2.x.x.x range as described at the start of the chapter.
- 2> Switch the console to System and select [DMX Settings].
- 3> The DMX Settings window should open.

- 4> Select the Art-Net module from the node list in the left hand side of the window.
- 5> Press the small 'i' button to show the node properties. Ensure that the correct Network adapter is set (this may not be the Default Adapter)
- 6> If you wish to turn off the Art-Net output, you can unselect the "Enable DMX output" option. This will stop the Console from outputting Art-Net on any Lines.
- 7> Art-Net normally only sends Data when it is changed, rather than a continuous stream. There are times when it is preferable to send Art-Net all the time. to do this, select the "Continuous Art-Net Data Stream" option.
- 8> The "Always broadcast Art-Net" option enables you to send Art-Net to the entire network, rather than a specific IP address.
- 9> Press the blue → arrow on the Art-Net node to connect it to a DMX output line.
- 10> Select a console DMX line from the right hand side of the window.
- 11> The DMX line will now be outputting over the selected Art-Net node.
- 12> Click 'i' on the node you have added to make sure the properties are correct. (Problems can be caused if you attach multiple DMX lines to a single node.)
- 13> Make sure that the Universe is set to 1 for Line 1, and 2 for Line 2.
Art-Net uses a subnet mask with its universe. For Titan purposes:
Titan universes 1 - 16 are subnet mask = 0, Art-Net universes = 1 – 16
- 14> You can close the DMX settings window.

The console should now be working correctly.

To remove a node from a DMX line, select the node and click the blue X button.

"Unpolled" and "unknown" devices may appear as Art-Net nodes.

- An unpolled device is a 'rolling extra' which allows more than 4 connections to be made to a particular Art-Net device. The Art-Net specification only allows each device to advertise a max of 4 universes so if you need to add more the console has to invent the 5th, 6th, etc universes.
- An unknown device is one which doesn't format an Art-Net poll reply properly so the console doesn't know if it is an input or output device.

18.2.5 ADDITIONAL ART-NET RESOURCES

To find out more information about Art-Net please refer to the Art-Net Standard published by Artistic Licence.

18.3 USING ACTIVE FIXTURES WITH CITP

CITP is a standard system allowing lighting devices to communicate and share information. This is often used with media servers to allow the console to get media thumbnail images and layer information from the server. The thumbnail images can then be used on the console to select media clips.

This section does not apply to Ai media servers which use the Synergy system to communicate with Titan consoles.

18.3.1 EXAMPLE CITP SETUP

This example shows how to set up a Hippotizer with Titan.

- 1> Connect the console and Hippotizer to the network. (You can connect the Hippotizer directly to the console, if no other devices are being connected, using a crossover patch cable).
- 2> Set up the IP addresses and subnet masks of the console and Hippo so that they are on the same address range, for example 192.168.0.1 and 192.168.0.2.
- 3> If you are using Titan Mobile or Titan Simulator ensure the firewall on your PC is disabled. Also ensure the Hippo machine is not running a firewall.
- 4> Run the Hippo system. Make sure the CITP component is running.
- 5> Switch the console to System mode and select [DMX Settings].
- 6> On the left hand side under Art-Net you should see the Hippo with its IP address. Click on it and then on the right hand side click on the DMX line you want to use it with.
- 7> On the Hippo node on the left hand side, click the "i" button and set the Universe number to match the universe setting on the Hippo.
- 8> <Exit> System mode back to the default menu.
- 9> Restart the console software using the option on the Tools menu (for Titan Mobile, Titan Go or Simulator just close and restart the Titan software).
- 10> Go into Patch mode and select [Active Fixtures]. You should see the Hippo with its IP address as a softkey option.
- 11> Select the Hippo, then set the DMX line to match the line you set in Step 6.
- 12> Press an empty fixture handle to patch. The console will automatically patch the required layers and master layer as a series of fixture buttons.
- 13> Now if you select a fixture and open the Attribute Editor window you should see the media thumbnails.

The next time you start the system, ensure the Hippo is powered up before you start the console.

If you decide to re-patch to a different DMX address you will need to re-start the Hippotizer software. You will also need to reset the Art-Net nodes if you are moving across DMX lines.

18.4 A QUICK GUIDE TO IP ADDRESSING

This section attempts to explain the basics of IP addressing, and what you will need to know when setting up a lighting control network.

IP addresses will normally come in the format "w.x.y.z" where w, x, y and z are numbers between 0 and 255. For example "192.168.0.1". Every object (or node or device) on a network should have a unique IP address. This is the same concept as DMX as each fixture requires a unique DMX address, for IP addresses the same is required.

18.4.1 SETTING YOUR IP ADDRESS

The console has a setup function to quickly set its IP address as described on page 347.

There is a strong possibility that if you set the IP address on one network device you will have to set it on all of them, therefore if you manually set your IP address on the console you will have to do it on any TitanNet devices you are using and any Art-Net fixtures. Beware that some Art-Net fixtures have a fixed IP address in the range 2.x.x.x, in which case you have to set the console to that range.

18.4.2 SUBNET MASKS

These are best kept simple. All devices or nodes on a network who wish to communicate with each other must have the same subnet mask. The mask determines which parts of the IP address are unique in that network to each node. If the part of the subnet mask is a 0 then the corresponding digit in an IP address must be unique for each fixture. If the part in a subnet mask is 255 then this part of the IP address needs to be the same for each node.

18.4.3 CHOOSING AN IP ADDRESS AND SUBNET MASK

This is the hardest part of setting up a network as your IP address totally depends on what you are using on the network and what IP addresses you can and cannot change. Below are a number of different scenarios for standard lighting networks using a Titan console and what IP addresses should be set. These aren't guaranteed to work but try them if the scenario matches your network:

Titan and TNP, all output is standard DMX.

	IP Address	Subnet Mask
Titan console	192.168.1.30	255.255.255.0
TNP	192.168.1.31	255.255.255.0

Titan outputting over Art-Net Fixtures (and DMX).

	IP Address	Subnet Mask
Titan console	2.100.100.100	255.0.0.0
Art-Net Fixtures	2.x.y.z	255.0.0.0

Or

	IP Address	Subnet Mask
Titan console	10.100.100.100	255.0.0.0
Art-Net Fixtures	10.x.y.z	255.0.0.0

Where a combination of x, y and z are unique for these fixtures.

Titan and TNP outputting over Art-Net (and DMX).

	IP Address	Subnet Mask
Titan console	2.100.100.100	255.0.0.0
TNP	2.100.100.101	255.0.0.0
Art-Net Fixtures	2.x.y.z	255.0.0.0

Or

	IP Address	Subnet Mask
Titan console	10.100.100.100	255.0.0.0
TNP	10.100.100.101	255.0.0.0
Art-Net Fixtures	10.x.y.z	255.0.0.0

Where a combination of x, y and z are unique for these fixtures.



Never set the last number of an IP address to be 255. This is a special address which will not function correctly.

18.4.4 AUTOMATICALLY ASSIGNING IP ADDRESSES (DHCP)

There is another way of assigning IP addresses via an automatic system called DHCP, where one of the computers on the network will automatically give other devices an IP address when it connects.

Generally we would not advise using DHCP on a lighting network as many nodes do not support it. If you must operate on a network with DHCP, most DHCP servers will have a reserved range of “static” addresses which can be manually set. You can usually find these out from the DHCP server configuration.

18.4.5 PRIVATE IP ADDRESS RANGES

If your network is connected to the internet it is important to use a private IP address range. These are special IP addresses that will not be routed onto the internet. They are:

Start Address	Final Address	Subnet Mask
10.0.0.0	10.255.255.255	255.0.0.0
172.16.0.0	172.31.255.255	255.255.0.0
192.168.0.0	192.168.255.255	255.255.255.0

For Art-Net, the 10.x.x.x range must be used.

19. TITAN COMMANDS QUICK REFERENCE

Please note that some commands may require <Enter> to complete the command. In this reference <Enter> has always been omitted for clarity.

[] means a softkey on the console.

< > means a physical labelled button

{ } means a handle button, e.g. {Cue} means the blue button on a cue playback handle

Numbers are typed on the numeric keypad

The available buttons may differ depending on which console you are using. If your console doesn't have the button, a softkey is also provided with the same function.

Some of the buttons in this guide have changed names and so here is a list of the old button names and their new equivalents.

Old Name	New Name
Connect	Cue
SET	TIME

19.1.1 FIXTURES

<Fixture> 1 <Through> 10

Select fixtures 1 through to 10.

<Fixture> 1 <Through> 10 <And> 20 <And> 25

Select fixtures 1 to 10 and 20, 25

<Fixture> 1 <Through> 10 <And> <,>2

Select the second cell of fixtures 1 to 10.

<Fixture> 1 <Through> 10 <And> <,>2

Select the second cell of fixtures 1 to 10.

<Fixture> 5 <@> <@>

Put fixture 5 at full intensity.

<Fixture> 1 <Through> 60 <@> 75

Put fixtures 10 to 60 at 75% intensity.

<Group> 2 <@> <@>

Put group 2 at full intensity.

<Group> 2 <@> 75

Put group 2 at full intensity.

CELLED FIXTURES (SUB FIXTURES)

<,> m

Select cell m in the selected fixtures.

<,>

Select all the cells in the selected fixtures.

n <.>

all sub fixtures of fixture n

1 <Through> 5 <.> 2

Select the second cell of fixtures 1 to 5

<.> <Through> <.> j

<Through> <.> j

Select cells 1 to j of all selected fixtures

<.> m <Through>

Cells m->last of all selected fixtures

<.> m <Through> <.>j

<.> m <Through> i

sub fixtures m->j or all selected fixtures

n <Through> i<.>

all sub fixtures of fixtures n->i

n <Through> i<.>j

sub fixture j of fixtures n->i

n <Through> <.>j

sub fixture 1->j of fixture n

n <.> <Through>

all sub fixtures of fixture n->last consecutive of type n

n <.> <Through> i

sub fixtures 1->i of fixture n

n <.> <Through> i<.>j

sub fixtures 1->j of fixtures n->i

19.1.2 SELECT IF

<Select If> <@><@>

Select all fixtures above 0% intensity.

<Select If> <@> <Through> 50

Select all fixtures above 50% intensity

<Select If> <@> 50 <Through>

Select all fixtures below 50% intensity

19.1.3 RECORD

<Record> {Cue} {Cue}

Merge the live cue with the programmer.

<Record> {Cue} 90.1

Merge cue 90.1 with the programmer.

<Record> {Cue} 1 {Through} 10 <And> 20

Merge programmer contents into cues 1 to 10 and 20.

<Record> <Position> {Cue} {Cue}

Merge all but position from the programmer with the live cue.

<Record> <Options> <Position> {Cue} {Cue}

Merge only position from the programmer with the live cue.

19.1.4 COPY, MOVE IN CUE LIST

<Copy> {Cue} n <Enter>

Copy cue n and append at the end of the cue list.

<Copy>/<Move> {Cue} 1 <Through> 10 [NOT] 5 <And> 20 <@> n

<Copy>/<Move> {Cue} 1 <Through> 10 [NOT] 5 <And> 20 <Enter> n <Enter>

Copy or move cues 1,2,3,4,6,7,8,9,10,20 and insert after cue n.

<Copy>/<Move> {Cue} 1 <Through> 10 [NOT] 5 <And> 20 <@> <@>

<Copy>/<Move> {Cue} 1 <Through> 10 [NOT] 5 <And> 20 <Enter> <Enter>

Copy or move cues 1,2,3,4,6,7,8,9,10,20 and insert at the end of the cue list.

**<Copy>/<Move> {Cue} 1 <Through> 10 [NOT] 5 <And> 20 <@> {target playback}
n**

**<Copy>/<Move> {Cue} 1 <Through> 10 [NOT] 5 <And> 20 <Enter> {target
playback} n <Enter>**

Copy or move cues 1,2,3,4,6,7,8,9,10,20 and insert at cue n in the target playback.

19.1.5 DELETE

<Delete> {Cue} n

Delete cue n from the connected cue list.

19.1.6 INCLUDE

<Include> {Cue} n

Include cue n into the programmer from the connected cue list.

19.1.7 TIMES

<Time> 5

5sec fade in

<Cue> 3 <Time> 5

5sec fade in on connected playback's cue 3

<Time> <Fixture> 5

5sec fade in for all attributes of selected fixtures

<Time> <Fixture> <Gobo> 5

5sec fade in for gobo attribute group of selected fixtures

<Time> <Fixture> <@> <B@> 5

5sec fade in for attribute connected to wheel B on selected fixtures

<Time> 5 <@> 3

5sec fade in, 3 sec delay

<Time> 5 <And> 2

5sec fade in, 2sec fade out

<Time> 1 <Through> 10

times spread across fixtures according to selection order

19.1.8 CUE LISTS

<Cue> n <Go>

Go to cue n (in connected cue list)

5 <Go>

Run the next cue with 5 sec fade instead of the programmed cue time

<Cue> 3 <Enter> 5 <Go>

Jump to cue 3 with 5 sec fade instead of the programmed cue time

20. INDEX

Softkey Menu items are indicated with capital letters (for example “Activate A Timecode Cuelist”)

@

@ button · 121

<

<Unfold> button · 230

A

acceleration mode of wheels · 114
 active fixture
 media thumbnail · 120
 active fixtures · 351
 active fixtures, patching · 93
 Add Swop button · 288
 adjust attribute values · 121
 Align fixtures · 125
 All button · 125
 always merge · 209
 Append · 229
 Append Cue (cue list) · 238
 Apply Time To Palette · 290
 Art-Net, setting up · 348
 As In · 251
 assign masters · 321
 attribute editor window · 115
 attribute groups · 124
 attributes
 controlling · 113
 entering numerically · 120
 setting · 113, 114
 auto connect chase · 329
 auto groups · 92, 136
 auto legend · 144
 auto open virtual keyboard · 65
 auto view on connect · 329
 autoloading playback in cue list · 239
 autoloading times · 240
 autosave options · 83
 AvoKey · 341

B

backing up show · 84
 backup · 302

banks of attributes buttons · 113
 battery disconnect switch · 52
 beat and cycles, shapes · 159
 beats per cycle, keyframe shapes · 163
 Blind mode · 199
 blind to live · 290
 block effect, pixel mapper · 171
 block shape · 155
 BPM master options · 285
 Bunch Up · 104, 152, 214
 busking · 290
 buttons rows/columns · 60

C

capture · 261
 capture, connecting external · 266
 cells / sub fixtures · 112
 channel button · 121
 channel grid window · 132
 chases
 appending new cues · 229
 connecting · 227
 cue linking · 235
 cue, fixture and attribute overlap · 232
 deleting · 214
 difference between chase and cue list · 237
 direction · 229
 editing using unfold function · 230
 global timing · 231
 individual cue times · 232
 inserting cues · 229
 pausing · 228
 recording · 225
 running · 226
 speed and crossfade · 228
 tap tempo · 231
 temporary speed · 227
 CITP · 351
 clear button · 111
 Clear button · 198
 clearing the console · 84
 colour picker · 115, 118
 commit, scene master · 288
 compatibility view · 63, 146
 Compensate for Rate Grand Master · 285
 connect button · 227
 console legend · 76, 321
 convert cue to cue list · 200
 copy chase · 230, 250
 copy cue · 213
 copy palette · 151
 copying

- fixtures · 103
- crossfade of chase · 228
- cue list
 - append cue · 238
 - attribute fade times · 252
 - autoload · 239
 - cue legends · 238
 - default delay/fade times · 237
 - difference between chase and cue list · 237
 - editing cues and times · 248
 - keyboard shortcuts · 241
 - killing · 243
 - loop · 256
 - macro link · 240
 - move cues · 246
 - move in dark · 244
 - recording · 237
 - setting times · 251
 - update · 247
- Cue Overlap · 232, 252
- cue view · 210
- cues
 - attribute fade times · 217, 233
 - deleting · 214
 - editing · 209
 - fade modes · 216
 - flashing · 200
 - include function · 212
 - playing back · 200
 - recording · 198
 - removing attributes · 212
 - setting fade times · 214
 - setting legends · 198
- curves · 335
- curves, fan · 127
- curves, fixture or attribute · 106
- custom/user fixture personalities · 343
- cycles, keyframe shapes · 163

D

- Delay Time · 216
- delete palette · 152
- deleting
 - chase · 214
 - cue · 214
- deleting patched fixtures · 104
- desk lamps · 55
- DHCP · 354
- dimmer shapes
 - fading in · 175
- dimmer, virtual · 114
- dimmers
 - entering numerically · 121
 - patching · 88
- display · 321
- display button · 61
- display setup · 321
- DMX address
 - displaying for fixture · 89
 - setting for fixture · 90
- DMX merge · 334
- DMX output mapping · 330

- DMX outputs · 53
- DMX overview tab · 333
- DMX Settings · 320
- DMX triggering · 295
- DMX workspace window · 100

E

- Edit Times · 214
- editing a cue · 209
- editing values · 132
- Editor · 197
- effect editor, key frame shapes · 161
- effects generator · 155
- effects palette · 147
- enter numeric values · 120
- exchange mapping · 101
- external display · 321

F

- fade curves · 335
- Fade Out Time · 216
- Fade Time · 216
- fade times for cues · 214
- fader wings · 49
- fading palettes · 152
- fading palettes over time · 290, 291
- Fan button · 126
- Fan curves · 127
- filter relevant palettes · 149
- filtered palettes · 149
- find fixture · 94
- firing a chase · 226
- Fix+1/Fix-1 buttons · 125
- fixture exchange · 100
- fixture layout · 136
- fixture macros · 139
- fixture offset · 106
- fixture order · 217, 253
- fixture order in a shape · 173
- Fixture Overlap · 216
- Fixture Overlap (chases) · 232, 253
- Fixture Overlap (cue lists) · 253
- fixture overlap (palettes) · 291
- fixture overlap with palettes · 153
- fixture page buttons · 88
- fixture personalities, custom · 343
- fixture personalities, downloading and installing · 342
- fixtures
 - changing page · 110
 - groups · 135
 - locating · 110
 - patching · 89
 - step through selection · 125
- Flip · 126
- freeze fixture or attribute · 107

G

Generic fixtures · 344
 global chase timing · 231
 go and stop · 228
 Go button · 241
 go button for cues · 201
 grand master fader · 283
 group
 fixture layout · 136
 Group button · 135
 group masters · 286
 group, remove fixture · 136
 grouping fixtures · 135
 groups
 playback · 205

H

halo colour for buttons · 64, 99
 handle · 87
 handle paging · 221
 handle worlds · 75
 headphone · 299
 HiLight button · 125
 HTP and LTP, explanation of · 200

I

import show · 82
 Include button · 212
 Insert (in unfold mode) · 247
 Insert (rec chase) · 229
 insert chase step · 230
 intensity window · 133
 Invert attributes · 105
 IP address, setting · 348
 IP addressing explained · 352
 IPCGBES groups · 124
 iPod/iPhone · 306

J

jump to step in chase · 229

K

key frame shapes · 160
 key profiles · 322
 keyboard
 touch · 65
 keyboard not working · 72
 keyboard shortcuts · 72
 keyboard, external · 55

L

latch menu · 66
 latching the copy menu · 214
 latching the rec cue menu · 198
 layer masters · 172
 layout editor · 137
 LED brightness · 329
 legend button · 146
 legend, pictures · 146
 legends
 setting for fixtures/dimmers · 98
 legends for cues in cue list · 238
 level matching of playbacks · 201
 licensing, AvoKey · 341
 limited watermark · 106
 limiting attribute range · 105
 Link (cue lists) · 251
 Link Offset · 251
 Load Show · 81
 loading a show · 81
 Locate button · 110
 locate, record new state · 111
 lock playback on handle · 221
 lock screen image · 74
 lock the console · 74
 locking a playback across pages · 289
 LTP and HTP, explanation of · 200

M

macro in cue list · 240
 macros · 139
 macros (keypress) · 72
 mapping attributes on exchanged fixtures · 101
 mask
 clear · 111
 mask, recording cue · 199
 mask, toggle groups · 143
 master faders · 283
 master faders, assigning · 283
 master overlap (palette) · 153
 master palette overlap · 153
 master palette time · 153
 master time (palette) · 153
 master-slave linking · 75
 media browser · 273
 media servers, setting up · 351
 midi connections · 55
 MIDI device ID · 329
 MIDI show control · 297
 MIDI timecode options · 329
 MIDI triggering · 295
 minimum palette mode · 145
 mode 0 - 3 for cues · 216
 mouse, external · 55
 move chase · 230, 249, 250
 move cue · 213
 move function · 292

move in dark · 244
 move palette · 151
 moving cues in cue list · 246
 Moving fixture · 103
 Multi-DMX fixture · 344
 multiple dimmers on one handle · 89
 multi-user · 74, 302

N

NDI streams, bandwidth · 276
 nested palettes · 145
 network backup · 302
 network connection · 55
 network switch, internal · 346
 New Show · 84

O

Off button · 212
 Offline editor · 77
 offset fixture attribute · 106
 offset, DMX patching · 91
 open button · 57
 optical network connection · 346
 order of fixtures · 217

P

page
 selecting fixture pages · 88
 page buttons · 149
 page buttons, use in set list window · 293
 page legends · 98, 201
 page release · 203
 pages of fixtures · 110
 pages of palettes · 149
 pages show/hide button · 88
 paging executor buttons · 202
 paging static playbacks · 202
 palette
 auto legend · 144
 Palette Bank buttons · 149
 palette fade button · 153
 palettes · 141
 creating · 142
 editing and deleting · 150
 fading over time · 152, 290, 291
 fixture overlap · 291
 master overlap · 153
 master time · 153
 recalling · 148
 setting legends · 146
 update · 151, 209
 viewing values · 149
 park fixture · 98
 patch view window · 95
 patching

attribute limits · 105
 copying fixtures · 103
 curves · 106
 deleting fixtures · 104
 dimmers · 88
 edit personality · 107
 fixtures · 89
 freezing attributes · 107
 inverting attributes · 105
 setting legends · 98
 sub fixtures · 93
 swap pan and tilt · 104
 Patching, show DMX channels · 89
 pattern selection · 122
 pausing a chase · 228
 pearl expert shows · 63
 pending dimmer · 91
 personality, editing · 107
 phase of shapes · 159
 phase offset · 159
 picture legend · 146
 picture legends · 63
 PioneerDJ · 299
 pixel mapper · 167
 layer masters · 172
 pixel mapper examples · 175
 pixel mapper preview · 170
 playback blind mode · 220
 playback groups · 205
 playback options
 chases · 234
 cues · 219
 playback paging · 326
 playback priority · 220
 playback run on power up · 204
 playback view · 210
 playbacks
 releasing · 202
 power on state · 204
 power on, auto run playback · 204
 preset palettes · 91
 Prev/Next buttons · 125
 priority setting for playback · 220
 Programmer · 197
 prompt area · 70
 prompt for merge · 326

Q

Quick build · 226
 quick build cue · 199
 quick palettes · 149
 quick record · 63
 palette · 145

R

random chase · 229
 range of cues · 249
 RDM · 93

Rec Step button · 248
 Rec Times button · 248
 Record (in unfold mode) · 230, 247
 Record Chase button · 225
 Record Cue button · 198
 recording macros · 72
 recover show · 84
 reinstalling software · 340
 release between cues · 235, 256
 release mask · 222
 release state · 204
 release to home · 202
 releasing playbacks · 202
 Rem Dim · 125
 remote control · 306
 remote trigger · 295
 remove fixtures from a shape · 174
 reports · 85
 resetting fixtures · 139
 Retain Layout · 104, 152, 214
 running a chase · 226

S

Save Show · 81
 saving show to hard disk · 80, 82
 scene master · 287
 Select a DMX line · 90
 Select Cue · 251
 Select Fix Page button · 110
 select if · 124
 selecting fixtures in a pattern · 122
 sessions view · 76
 Set Cue Times (in unfold mode) · 230
 Set Fixture Order · 253
 Set IPCGBES Times · 217, 233
 Set Legend button · 98, 198
 set list window · 292
 Set Out Time · 251
 setting attributes · 114
 Setup button · 80, 82
 shape behaviour · 166
 shape direction · 159
 shape generator · 155
 shape palette · 147
 shape speed and size · 158
 shape tracking · 239
 shapes
 deleting · 174
 editing shape in a cue · 173
 fading in · 174
 fixture order · 173
 live editing · 172
 phase · 159
 reversing · 174
 shapes window · 156
 shortcut keys · 72
 show file
 saving and loading · 81
 show library · 82

Show Library · 78
 showing cue list · 241
 simulator · 77
 Snap Back button (cue lists) · 242
 Snap button · 242
 software, recovery · 340
 software, upgrading · 339
 sound to light · 298
 Speed (chase) · 231
 speed masters · 284
 speed multiplier
 chases · 234
 speed of chase · 228
 speed/size masters · 202
 spread of shapes · 159
 Stop button (cue lists) · 242
 Store Palette · 142
 sub fixtures · 93
 sub fixtures, selection · 112
 swap fixture addresses · 97
 swap items if required · 104, 152, 214
 Swap Pan Tilt · 104
 synergy · 269
 synergy fixtures · 272
 synergy settings · 269
 system menu · 320

T

tap tempo · 231
 tempo units · 327
 temporary chase speed · 327
 temporary speed · 227
 text size · 326
 theatre mode · 237
 Tiger Touch wing · 49
 timecode · 254
 timed flash · 288
 times, setting into programmer · 218
 Titan Go · 43
 Titan Mobile wing · 49
 Titan simulator · 77
 Titan telemetry · 321
 TitanNet overview · 333
 TNP modes · 312
 toggle mask · 143
 touch button size · 326
 touch keyboard · 65
 trackball · 64, 113
 transparent lock · 221, 289
 Triggers · 321

U

unassign · 214
 undo/redo · 70
 unfold
 cue list · 247

Unknown fixtures · 344
unlinking chase cues · 232
update · 151, 209, 247
update mode · 249
update personalities · 103
upgrading the software · 339
UPS · 51
USB MIDI · 295
user number · 89
user settings menu · 320, 324

V

VDU · 321
version compatibility · 69
video multi view · 274
view button · 57
view DMX output · 100
view effects · 150
view if, intensity window · 134
view menu · 291
view shapes · 150
viewing key profiles · 322
virtual dimmer · 114
visualiser · 261

Visualiser · 70
Visualiser auto patch · 92

W

warn before parking fixtures · 326
Wheel sensitivity · 329
wheels
 acceleration · 114
 controlling attributes · 114
 fast mode · 114
wheels= softkey · 131
window positions · 57, 59
wings, connecting · 55
Wipe · 321
wipeall · 84
workspace
 positioning windows · 57
 saving · 62
 window options · 59

X

X in fixture order · 217